

Data Sheet | Item Number: 264-254

4-conductor terminal strip; without push-buttons; with snap-in mounting feet; 4-pole; for plate thickness 0.6 - 1.2 mm; Fixing hole 3.5 mm Ø; 2.5 mm²; CAGE CLAMP®; gray

<https://www.wago.com/264-254>

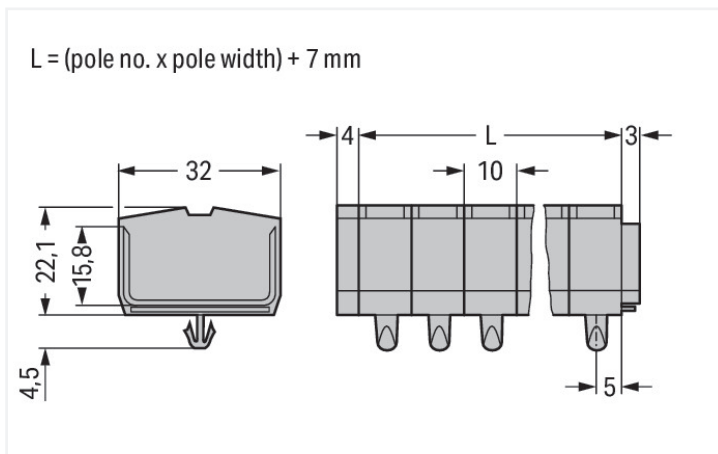
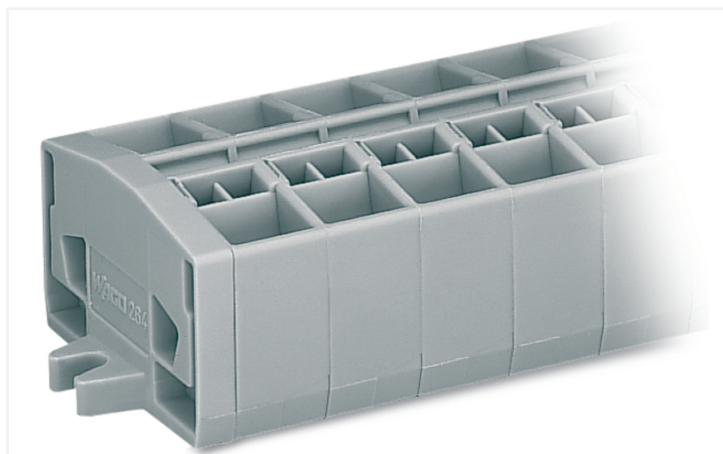

Color: ■ gray

Similar to illustration

Dimensions in mm

Through terminal block, 264 Series, CAGE CLAMP®

Easily, quickly and safely connect conductors with this through terminal block (item number 264-254). Ensure that the strip lengths are between 8 and 9 mm when connecting conductors to this through terminal block. Our mini rail-mount terminal blocks are perfect for tight spaces thanks to their compact design. You can also choose from a range of mounting and actuation variants for unparalleled flexibility, making it easy to select the ideal mini terminal block for each use. This product features conductor terminals and utilizes CAGE CLAMP®. Our highly-rated and maintenance-free CAGE CLAMP® connection makes it easy to connect all conductor types without having to prepare the conductor. For example, you don't need to crimp ferrules. The dimensions are (47 x 32 x 26.6) mm (width x height x depth). This through terminal block is suitable for conductor cross sections ranging from 0.08 mm² to 2.5 mm².

This mini rail-mount terminal block is operated with an operating tool.

Electrical data

Ratings per IEC/EN

Nominal voltage (III/3)	800 V
Rated impulse withstand voltage (III / 3)	8 kV
Rated current	24 A
Legend (ratings)	(III / 3) ≙ Overvoltage category III / Pollution degree 3

Approvals per

	UL 1059		
Use group	B	C	D
Rated voltage	600 V	600 V	-
Rated current	20 A	20 A	-

Approvals per

CSA 22.2 No 158

	B	C	D
Use group	B	C	D
Rated voltage	-	600 V	-
Rated current	-	20 A	-

General information

Wiring direction	Front-entry wiring
------------------	--------------------

Connection Data

Clamping units	16
Total number of potentials	4
Number of levels	1

Connection 1

Connection technology	CAGE CLAMP®
Actuation type	Operating tool
Connectable conductor materials	Copper
Solid conductor	0.08 ... 2.5 mm ² / 28 ... 12 AWG
Fine-stranded conductor	0.08 ... 2.5 mm ² / 28 ... 12 AWG
Note (conductor cross-section)	12 AWG: THHN, THWN
Strip length	8 ... 9 mm / 0.31 ... 0.35 inches
Pole number	4
Wiring direction	Front-entry wiring

Physical data

Width	47 mm / 1.85 inches
Height	32 mm / 1.26 inches
Height from the surface	22.1 mm / 0.87 inches
Depth	26.6 mm / 1.047 inches
Module width	10 mm / 0.394 inches

Mechanical data

Design	horizontal type
Mounting type	Snap-in foot
Marking level	Center marking

Material data

Note (material data)	Information on material specifications can be found here
Color	gray
Material group	I
Insulation material (main housing)	Polyamide (PA66)
Flammability class per UL94	V0
Fire load	0.462 MJ
Halogen-free	Yes
Weight	27.5 g

Environmental requirements

Processing temperature	-35 ... +85 °C
Continuous operating temperature	-60 ... +105 °C

Commercial data

Product Group	9 (Std Chassis Mt Blocks)
PU (SPU)	50 pcs
Packaging type	Box
Country of origin	DE
GTIN	4044918416023
Customs tariff number	85369010000

Product Classification

UNSPSC	39121410
eCl@ss 10.0	27-14-11-06
eCl@ss 9.0	27-14-11-06
ETIM 9.0	EC001284
ETIM 10.0	EC001284
ECCN	NO US CLASSIFICATION

Environmental Product Compliance

RoHS Compliance Status	Compliant, No Exemption
------------------------	-------------------------

Approvals / Certificates

General approvals



Approval	Standard	Certificate Name
CB DEKRA Certification B.V.	EN 60998	NL-49768
CCA DEKRA Certification B.V.	EN 60998	NTR NL-7342
CCA DEKRA Certification B.V.	EN 60998	2175624.01
CSA DEKRA Certification B.V.	C22.2	70010891
UR Underwriters Laboratories Inc.	UL 1059	E45172

Declarations of conformity and manufacturer's declarations

Approval	Standard	Certificate Name
EU-Declaration of Conformity WAGO GmbH & Co. KG	-	-
UK-Declaration of Conformity WAGO GmbH & Co. KG	-	-

Approvals for marine applications



Approval	Standard	Certificate Name
ABS American Bureau of Shipping	-	24-0095979-PDA
DNV GL Det Norske Veritas, Germanischer Lloyd	-	TAE00001V2
LR Lloyds Register	IEC 60998	LR22173030TA
PRS Polski Rejestr Statków	-	TE/1094/880590/23

Downloads

Environmental Product Compliance

Compliance Search	
Environmental Product Compliance 264-254	↓

Documentation

Bid Text			
264-254	19.02.2019	xml 3.21 KB	↓
264-254	14.06.2017	doc 25.50 KB	↓

CAD/CAE-Data

CAD data
2D/3D Models 264-254

CAE data
EPLAN Data Portal 264-254
WSCAD Universe 264-254
ZUKEN Portal 264-254

1 Compatible Products

1.1 Optional Accessories

1.1.1 DIN-rail

1.1.1.1 Mounting accessories



Item No.: 210-154
Aluminum carrier rail; 1000 mm long; 18 mm wide; 7 mm high; silver-colored

1.1.2 Ferrule

1.1.2.1 Ferrule

<p>Item No.: 216-131 Ferrule; Sleeve for 0.25 mm² / AWG 24; un-insulated; electro-tin plated; silver-colored</p>	<p>Item No.: 216-201 Ferrule; Sleeve for 0.5 mm² / 20 AWG; insulated; electro-tin plated; electrolytic copper; acc. to DIN 46228, Part 4/09.90; white</p>	<p>Item No.: 216-101 Ferrule; Sleeve for 0.5 mm² / AWG 22; un-insulated; electro-tin plated; silver-colored</p>	<p>Item No.: 216-202 Ferrule; Sleeve for 0.75 mm² / 18 AWG; insulated; electro-tin plated; gray</p>
<p>Item No.: 216-102 Ferrule; Sleeve for 0.75 mm² / 18 AWG; un-insulated; electro-tin plated; silver-colored</p>	<p>Item No.: 216-203 Ferrule; Sleeve for 1 mm² / AWG 18; insulated; electro-tin plated; red</p>	<p>Item No.: 216-103 Ferrule; Sleeve for 1 mm² / AWG 18; un-insulated; electro-tin plated</p>	<p>Item No.: 216-204 Ferrule; Sleeve for 1.5 mm² / AWG 16; insulated; electro-tin plated; black</p>

1.1.2.1 Ferrule



Item No.: 216-104

Ferrule; Sleeve for 1.5 mm² / AWG 16; unin-sulated; electro-tin plated; silver-colored

Item No.: 216-205

Ferrule; Sleeve for 2.08 mm² / AWG 14; in-sulated; electro-tin plated; yellow

Item No.: 216-206

Ferrule; Sleeve for 2.5 mm² / AWG 14; in-sulated; electro-tin plated; blue

1.1.3 Installation

1.1.3.1 Cover



Item No.: 709-153

Cover; Type 1; suitable for cover carrier, type 1; 1 m long; transparent

1.1.3.2 Cover carrier



Item No.: 709-167

Cover carrier; Type 1; incl. fixing/retaining screws and knurled nut; suitable for 279 to 282 and 880 Series rail-mounted terminal blocks; suitable for 264 Series miniature rail-mounted terminal blocks; suitable for 270 Series sensor and actuator terminal blocks; gray

1.1.4 Jumper

1.1.4.1 Jumper



Item No.: 280-492

Jumper; 2-way; insulated; gray

Item No.: 264-402

Jumper; for conductor entry; 2-way; insulated; gray

1.1.5 Marking

1.1.5.1 Marker



Item No.: 2009-145/000-006

Mini-WSB Inline; for Smart Printer; 1700 pieces on roll; stretchable 5 - 5.2 mm; plain; snap-on type; blue

Item No.: 2009-145/000-007

Mini-WSB Inline; for Smart Printer; 1700 pieces on roll; stretchable 5 - 5.2 mm; plain; snap-on type; gray

Item No.: 2009-145/000-023

Mini-WSB Inline; for Smart Printer; 1700 pieces on roll; stretchable 5 - 5.2 mm; plain; snap-on type; green

Item No.: 2009-145/000-012

Mini-WSB Inline; for Smart Printer; 1700 pieces on roll; stretchable 5 - 5.2 mm; plain; snap-on type; orange



Item No.: 2009-145/000-005

Mini-WSB Inline; for Smart Printer; 1700 pieces on roll; stretchable 5 - 5.2 mm; plain; snap-on type; red

Item No.: 2009-145/000-024

Mini-WSB Inline; for Smart Printer; 1700 pieces on roll; stretchable 5 - 5.2 mm; plain; snap-on type; violet

Item No.: 2009-145

Mini-WSB Inline; for Smart Printer; 1700 pieces on roll; stretchable 5 - 5.2 mm; plain; snap-on type; white

Item No.: 2009-145/000-002

Mini-WSB Inline; for Smart Printer; 1700 pieces on roll; stretchable 5 - 5.2 mm; plain; snap-on type; yellow



Item No.: 248-501/000-006

Mini-WSB marking card; as card; not stretchable; plain; snap-on type; blue

Item No.: 248-501/000-007

Mini-WSB marking card; as card; not stretchable; plain; snap-on type; gray

Item No.: 248-501/000-023

Mini-WSB marking card; as card; not stretchable; plain; snap-on type; green

Item No.: 248-501/000-017

Mini-WSB marking card; as card; not stretchable; plain; snap-on type; light green

1.1.5.1 Marker



Item No.: 248-501/000-012

Mini-WSB marking card; as card; not stretchable; plain; snap-on type; orange

Item No.: 248-501/000-005

Mini-WSB marking card; as card; not stretchable; plain; snap-on type; red

Item No.: 248-501/000-024

Mini-WSB marking card; as card; not stretchable; plain; snap-on type; violet

Item No.: 248-501

Mini-WSB marking card; as card; not stretchable; plain; snap-on type; white



Item No.: 248-501/000-002

Mini-WSB marking card; as card; not stretchable; plain; snap-on type; yellow

1.1.6 Test and measurement

1.1.6.1 Testing accessories



Item No.: 249-139

Test plug module; without locking device; modular; for 4-conductor terminal blocks; gray

Item No.: 210-136

Test plug; 2 mm Ø; with 500 mm cable; red

1.1.7 Tool

1.1.7.1 Operating tool



Item No.: 210-658

Operating tool; Blade: 3.5 x 0.5 mm; with a partially insulated shaft; angled; short; multi-coloured

Item No.: 210-720

Operating tool; Blade: 3.5 x 0.5 mm; with a partially insulated shaft; multicoloured

Item No.: 210-657

Operating tool; Blade: 3.5 x 0.5 mm; with a partially insulated shaft; short; multi-coloured

Item No.: 209-130

Operating tool; made of insulating material; 1-way; for 264 Series (1-/2-way), 280, 281 Series (up to 3-way); natural



Item No.: 280-432

Operating tool; made of insulating material; 2-way; white

Installation Notes

Installation

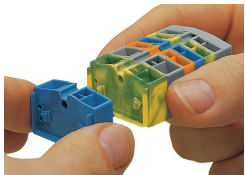

Assembling modular terminal blocks into terminal strips.

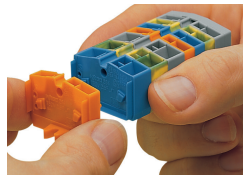

Mounting an "end terminal block" with mounting flange.

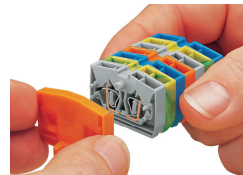

Mounting an end plate.

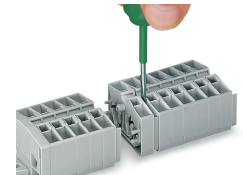

Removing a terminal block.

Conductor termination



CAGE CLAMP® connection

Inserting a conductor.

With ferruled conductors, it is necessary to use a terminal block one size smaller than the conductor's nominal cross-section.

Commoning

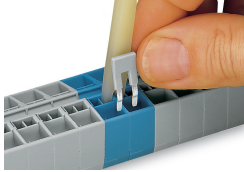

Commoning with comb-style jumper bar.

Testing

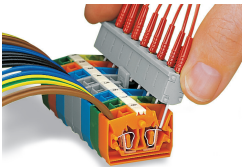

Testing by touch contact to the CAGE CLAMP® spring (limited to 0.5 A and 48 V test voltage) – test pins are not protected against accidental contact.

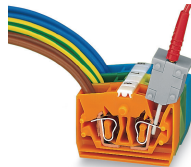

Testing via CAGE CLAMP® on the current bar (max. nominal current: 6 A). CAGE CLAMP® clamps individual test contacts. The maximum test voltage is 400 V.

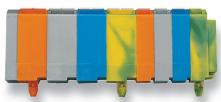

Terminal strip with mounting flanges, consisting of:

- End plate
- 4-conductor terminal block with snap-in mounting foot¹⁾
- Center terminal blocks
- 2-conductor terminal block with snap-in mounting foot¹⁾¹⁾ at every 4th or 5th terminal block of the strip

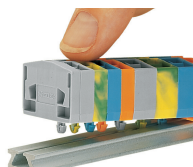
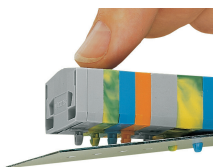

Mounting a terminal strip with snap-in feet into holes.

Mounting a terminal strip with snap-in feet onto aluminum rail.

Marking



Marking via Mini-WSB Quick Marking System.