

## Data Sheet | Item Number: 256-408

PCB terminal block; push-button; 2.5 mm<sup>2</sup>; Pin spacing 5/5.08 mm; 8-pole; CAGE CLAMP®; commoning option; gray

<https://www.wago.com/256-408>



Color: ■ gray

Similar to illustration

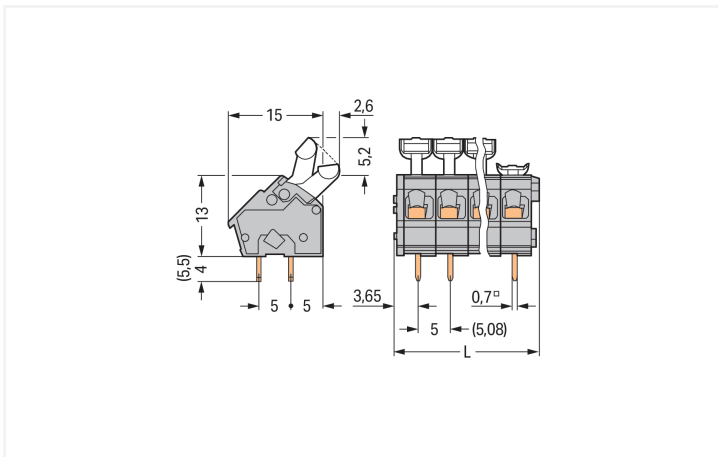
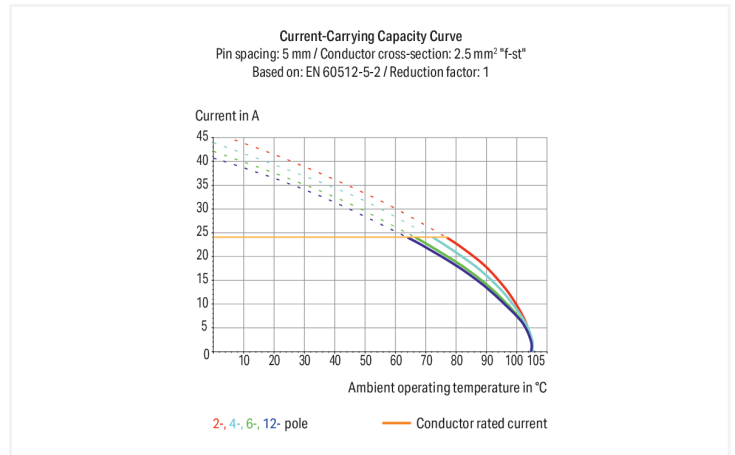

Dimensions in mm

L = (pole no. x pin spacing) + 2.9 mm

PCB terminal block, 256 Series, solder pin dimensions 0.7 x 0.7 mm

This PCB terminal block (item number 256-408) is designed to connect conductors quickly and easily. It is ideal for custom installations with different mounting types. Conductors can only be connected to this PCB terminal block if their strip length is between 5 and 6 mm. Featuring one conductor terminal along with CAGE CLAMP®, this connector outperforms the competition. Our celebrated universal connection known as CAGE CLAMP® is the industry standard for connection technology and electrical interconnections. Dimensions: (42.9 x 22.2 x 17.6) mm (width x height x depth). This PCB terminal block is suitable for conductor cross sections ranging from 0.08 mm<sup>2</sup> to 2.5 mm<sup>2</sup>.

The contact surface is coated with tin. A push-button is used to operate this PCB terminal block. The PCB terminal block is designed for THT soldering. The conductor is designed to be inserted into the board at a 45° angle..

## Notes

Variants:	Other pole numbers Versions for Ex e II and Ex i Other colors Mixed-color PCB connector strips Direct marking Other versions (or variants) can be requested from WAGO Sales or configured at <a href="https://configurator.wago.com/">https://configurator.wago.com/</a> .
-----------	---

## Electrical data

Ratings per	IEC/EN 60664-1		
Overvoltage category	III	III	II
Pollution degree	3	2	2
Nominal voltage	250 V	320 V	630 V
Rated impulse withstand voltage	4 kV	4 kV	4 kV
Rated current	24 A	24 A	24 A

Approvals per	UL 1059		
Use group	B	C	D
Rated voltage	300 V	-	300 V
Rated current	15 A	-	10 A

Approvals per	CSA		
Use group	B	C	D
Rated voltage	300 V	-	300 V
Rated current	15 A	-	10 A

## Connection Data

Clamping units	8
Total number of potentials	8
Number of connection types	1
Number of levels	1

Connection 1	
Connection technology	CAGE CLAMP®
Actuation type	Push-button
Solid conductor	0.08 ... 2.5 mm <sup>2</sup> / 28 ... 12 AWG
Fine-stranded conductor	0.08 ... 2.5 mm <sup>2</sup> / 28 ... 12 AWG
Fine-stranded conductor; with insulated ferrule	0.25 ... 1.5 mm <sup>2</sup>
Fine-stranded conductor; with uninsulated ferrule	0.25 ... 1.5 mm <sup>2</sup>
Note (conductor cross-section)	12 AWG: THHN, THWN
Strip length	5 ... 6 mm / 0.2 ... 0.24 inches
Conductor connection direction to PCB	45°
Pole number	8

## Physical data

Pin spacing	5/5.08 mm / 0.197/0.2 inches
Width	42.9 mm / 1.689 inches
Height	22.2 mm / 0.874 inches
Height from the surface	18.2 mm / 0.717 inches
Depth	17.6 mm / 0.693 inches
Solder pin length	4 mm
Solder pin dimensions	0.7 x 0.7 mm
Drilled hole diameter	1.1 <sup>(+0.1)</sup> mm

### PCB contact

PCB contact	THT
Solder pin arrangement	over the entire terminal strip (in-line)
Number of solder pins per potential	2

### Material data

Note (material data)	<a href="#">Information on material specifications can be found here</a>
Color	gray
Material group	I
Insulation material (main housing)	Polyamide (PA66)
Flammability class per UL94	V0
Clamping spring material	Chrome-nickel spring steel (CrNi)
Contact material	Electrolytic copper (E <sub>cu</sub> )
Contact Plating	Tin
Fire load	0.1 MJ
Weight	7.8 g

### Environmental requirements

Limit temperature range	-60 ... +105 °C
-------------------------	-----------------

### Commercial data

Product Group	4 (Printed Circuit Connectors)
PU (SPU)	100 (25) pcs
Packaging type	Box
Country of origin	CH
GTIN	4044918756983
Customs tariff number	85369010000

### Product Classification

UNSPSC	39121409
eCl@ss 10.0	27-44-04-01
eCl@ss 9.0	27-44-04-01
ETIM 9.0	EC002643
ETIM 10.0	EC002643
ECCN	NO US CLASSIFICATION

### Environmental Product Compliance

RoHS Compliance Status	Compliant, No Exemption
------------------------	-------------------------

### Approvals / Certificates

#### General approvals



Approval	Standard	Certificate Name
CCA DEKRA Certification B.V.	EN 60947	2160584.34
CCA DEKRA Certification B.V.	EN 60947	NTR NL-7138
CCA DEKRA Certification B.V.	IEC 60947-7-4	71-113042

#### General approvals

CSA DEKRA Certification B.V.	C22.2 No. 158	70049157
UL Underwriters Laboratories Inc.	UL 1059	20190731-E45172

Declarations of conformity and manufacturer's declarations

Approval	Standard	Certificate Name
EU-Declaration of Conformity WAGO GmbH & Co. KG	-	-
UK-Declaration of Conformity WAGO GmbH & Co. KG	-	-

Approvals for marine applications



Approval	Standard	Certificate Name
ABS American Bureau of Shipping	-	24-0095975-PDA
BV Bureau Veritas S.A.	IEC 60998	11915/E0 BV
DNV DNV GL SE	-	TAE000016Z
PRS Polski Rejestr Statków	-	TE/1095/880590/23

Downloads

Environmental Product Compliance

Compliance Search	
Environmental Product Compliance 256-408	<a href="#">↓</a>

Documentation

Additional Information			
Technical Section	03.04.2019	pdf 2027.26 KB	<a href="#">↓</a>
Gebrückte Klemmenleisten für Leiterplatten		pdf 303.71 KB	<a href="#">↓</a>

CAD/CAE-Data

CAD data	
2D/3D Models 256-408	<a href="#">↓</a>

CAE data	
EPLAN Data Portal 256-408	<a href="#">↓</a>
ZUKEN Portal 256-408	<a href="#">↓</a>

PCB Design

Symbol and Footprint via SamacSys 256-408	<a href="#">↓</a>
Symbol and Footprint via Ultra Librarian 256-408	<a href="#">↓</a>

## 1 Compatible Products

### 1.1 Optional Accessories

#### 1.1.1 Ferrule

##### 1.1.1.1 Ferrule



**Item No.: 216-321**

Ferrule; Sleeve for 0.25 mm<sup>2</sup> / AWG 24; insulated; electro-tin plated; yellow



**Item No.: 216-151**

Ferrule; Sleeve for 0.25 mm<sup>2</sup> / AWG 24; uninsulated; electro-tin plated



**Item No.: 216-322**

Ferrule; Sleeve for 0.34 mm<sup>2</sup> / 22 AWG; insulated; electro-tin plated; light turquoise



**Item No.: 216-152**

Ferrule; Sleeve for 0.34 mm<sup>2</sup> / AWG 24; uninsulated; electro-tin plated



**Item No.: 216-221**

Ferrule; Sleeve for 0.5 mm<sup>2</sup> / 20 AWG; insulated; electro-tin plated; white



**Item No.: 216-121**

Ferrule; Sleeve for 0.5 mm<sup>2</sup> / AWG 22; uninsulated; electro-tin plated; silver-colored



**Item No.: 216-222**

Ferrule; Sleeve for 0.75 mm<sup>2</sup> / 18 AWG; insulated; electro-tin plated; gray



**Item No.: 216-122**

Ferrule; Sleeve for 0.75 mm<sup>2</sup> / AWG 20; uninsulated; electro-tin plated; silver-colored



**Item No.: 216-223**

Ferrule; Sleeve for 1 mm<sup>2</sup> / AWG 18; insulated; electro-tin plated; red



**Item No.: 216-123**

Ferrule; Sleeve for 1 mm<sup>2</sup> / AWG 18; uninsulated; electro-tin plated; silver-colored



**Item No.: 216-224**

Ferrule; Sleeve for 1.5 mm<sup>2</sup> / AWG 16; insulated; electro-tin plated; black



**Item No.: 216-124**

Ferrule; Sleeve for 1.5 mm<sup>2</sup> / AWG 16; uninsulated; electro-tin plated

### 1.1.2 Tool

#### 1.1.2.1 Operating tool



**Item No.: 210-658**

Operating tool; Blade: 3.5 x 0.5 mm; with a partially insulated shaft; angled; short; multicoloured



**Item No.: 210-720**

Operating tool; Blade: 3.5 x 0.5 mm; with a partially insulated shaft; multicoloured

## Installation Notes

### Conductor termination



Inserting/removing a conductor – 256 Series.

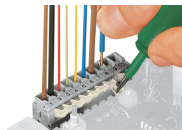

Inserting/removing a conductor (255 Series)

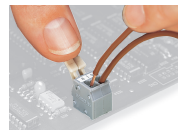

Inserting/removing a conductor via finger-operated lever – 255 Series.

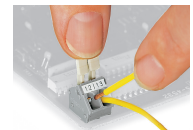

Inserting/removing a conductor via finger-operated lever – 256 Series.

## Installation

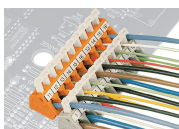

Possible conductor arrangement with terminal strips staggered (for 256 Series only).

## Marking



Formation of groups using housings of different colors

## Testing

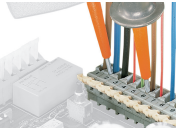

Testing with test probes.



Testing with test plug modules.