

FRONT-MC 1,5/ 3-STF-3,81 - PCB connectors



1850864

<https://www.phoenixcontact.com/us/products/1850864>

Please be informed that the data shown in this PDF document is generated from our online catalog. Please find the complete data in the user documentation. Our general terms of use for downloads are valid.



PCB connector, nominal cross section: 1.5 mm², color: green, nominal current: 8 A, rated voltage (III/2): 160 V, contact surface: Tin, contact connection type: Socket, number of potentials: 3, number of rows: 1, number of positions: 3, number of connections: 3, product range: FRONT-MC 1,5/...-STF, pitch: 3.81 mm, connection method: Front screw connection, screw head form: L Slotted, conductor/PCB connection direction: 0 °, plug-in system: COMBICON MC 1,5, locking: Screw locking mechanism, mounting: Screw flange, type of packaging: packed in cardboard

Your advantages

- Well-known connection principle allows worldwide use
- Low temperature rise, thanks to maximum contact force
- Screwable flange for superior mechanical stability
- Optimized for tight installation situations: operation and conductor connection from one direction

Commercial data

Item number	1850864
Packing unit	250 pc
Minimum order quantity	250 pc
Sales key	AA02
Product key	AABALB
Catalog page	Page 195 (C-1-2013)
GTIN	4017918110024
Weight per piece (including packing)	4.845 g
Weight per piece (excluding packing)	4.707 g
Customs tariff number	85366990
Country of origin	DE

FRONT-MC 1,5/ 3-STF-3,81 - PCB connectors



1850864

<https://www.phoenixcontact.com/us/products/1850864>

Technical data

Product properties

Product type	PCB connector
Product family	FRONT-MC 1,5/..-STF
Product line	COMBICON Connectors S
Type	Standard
Number of positions	3
Pitch	3.81 mm
Number of connections	3
Number of rows	1
Number of potentials	3
Mounting flange	Screw flange

Electrical properties

Nominal current I_N	8 A
Nominal voltage U_N	160 V
Contact resistance	1.6 mΩ
Rated voltage (III/3)	160 V
Rated surge voltage (III/3)	2.5 kV
Rated voltage (III/2)	160 V
Rated surge voltage (III/2)	2.5 kV
Rated voltage (II/2)	320 V
Rated surge voltage (II/2)	2.5 kV

Connection data

Connection technology

Type	Standard
Connector system	COMBICON MC 1,5
Nominal cross section	1.5 mm ²
Contact connection type	Socket

Interlock

Locking type	Screw locking mechanism
Mounting flange	Screw flange
Tightening torque	0.3 Nm

Conductor connection

Connection method	Front screw connection
Conductor/PCB connection direction	0 °
Conductor cross section rigid	0.14 mm ² ... 1.5 mm ²
Conductor cross section flexible	0.14 mm ² ... 1.5 mm ²
Conductor cross section AWG	28 ... 16
Conductor cross section flexible, with ferrule without plastic	0.25 mm ² ... 1.5 mm ²

FRONT-MC 1,5/ 3-STF-3,81 - PCB connectors



1850864

<https://www.phoenixcontact.com/us/products/1850864>

sleeve	
Conductor cross section, flexible, with ferrule, with plastic sleeve	0.25 mm ² ... 0.5 mm ²
2 conductors with same cross section, solid	0.14 mm ² ... 0.5 mm ²
2 conductors with same cross section, flexible	0.14 mm ² ... 0.75 mm ²
2 conductors with same cross section, flexible, with ferrule without plastic sleeve	0.25 mm ² ... 0.34 mm ²
2 conductors with the same cross section, flexible, with TWIN ferrule with plastic sleeve	0.5 mm ² ... 0.5 mm ²
Cylindrical gauge a x b / diameter	2.4 mm x 1.5 mm / 1.6 mm
Stripping length	9 mm
Drive form screw head	Slotted (L)
Tightening torque	0.22 Nm ... 0.25 Nm

Specifications for ferrules without insulating collar

ferrules without insulating collar, according to DIN 46228-1	Cross section: 0.25 mm ² ; Length: 7 mm ... 9 mm
	Cross section: 0.34 mm ² ; Length: 7 mm ... 9 mm
	Cross section: 0.5 mm ² ; Length: 8 mm ... 9 mm
	Cross section: 0.75 mm ² ; Length: 8 mm ... 9 mm
	Cross section: 1 mm ² ; Length: 8 mm ... 9 mm
	Cross section: 1.5 mm ² ; Length: 9 mm

Specifications for ferrules with insulating collar

ferrules with insulating collar, according to DIN 46228-4	Cross section: 0.25 mm ² ; Length: 8 mm ... 9 mm
	Cross section: 0.34 mm ² ; Length: 8 mm ... 9 mm
	Cross section: 0.5 mm ² ; Length: 8 mm ... 9 mm

Material specifications

Material data - contact

Note	WEEE/RoHS-compliant, free of whiskers according to IEC 60068-2-82/JEDEC JESD 201
Contact material	Cu alloy
Surface characteristics	hot-dip tin-plated
Metal surface terminal point (top layer)	Tin (4 - 8 μm Sn)
Metal surface contact area (top layer)	Tin (4 - 8 μm Sn)

Material data - housing

Color (Housing)	green (6021)
Insulating material	PA
Insulating material group	I
CTI according to IEC 60112	600
Flammability rating according to UL 94	V0
Glow wire flammability index GWFI according to EN 60695-2-12	850
Glow wire ignition temperature GWIT according to EN 60695-2-13	775
Temperature for the ball pressure test according to EN 60695-10-2	125 °C

FRONT-MC 1,5/ 3-STF-3,81 - PCB connectors



1850864

<https://www.phoenixcontact.com/us/products/1850864>

Dimensions

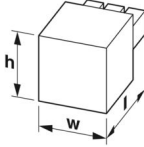
Dimensional drawing	
Pitch	3.81 mm
Width [w]	21.82 mm
Height [h]	12.3 mm
Length [l]	21.7 mm

Mounting

Flange

Tightening torque	0.3 Nm
-------------------	--------

Mechanical tests

Test for conductor damage and slackening

Specification	IEC 60999-1:1999-11
Result	Test passed

Pull-out test

Specification	IEC 60999-1:1999-11
Conductor cross section/conductor type/tractive force setpoint/actual value	0.14 mm ² / solid / > 10 N
	0.14 mm ² / flexible / > 10 N
	1.5 mm ² / solid / > 40 N
	1.5 mm ² / flexible / > 40 N

Insertion and withdrawal forces

Result	Test passed
No. of cycles	25
Insertion strength per pos. approx.	7 N
Withdraw strength per pos. approx.	5 N

Torque test

Specification	IEC 60999-1:1999-11
---------------	---------------------

Resistance of inscriptions

Specification	IEC 60068-2-70:1995-12
Result	Test passed

Polarization and coding

Specification	IEC 60512-13-5:2006-02
Result	Test passed

FRONT-MC 1,5/ 3-STF-3,81 - PCB connectors



1850864

<https://www.phoenixcontact.com/us/products/1850864>

Visual inspection

Specification	IEC 60512-1-1:2002-02
Result	Test passed

Dimension check

Specification	IEC 60512-1-2:2002-02
Result	Test passed

Environmental and real-life conditions

Vibration test

Specification	IEC 60068-2-6:2007-12
Frequency	10 - 150 - 10 Hz
Sweep speed	1 octave/min
Amplitude	0.35 mm (10 Hz ... 60.1 Hz)
Acceleration	5g (60.1 Hz ... 150 Hz)
Test duration per axis	2.5 h

Durability test

Specification	IEC 60512-9-1:2010-03
Impulse withstand voltage at sea level	2.95 kV
Contact resistance R ₁	1.6 mΩ
Contact resistance R ₂	1.7 mΩ
Insertion/withdrawal cycles	25
Insulation resistance, neighboring positions	> 5 MΩ

Climatic test

Specification	ISO 6988:1985-02
Corrosive stress	0.2 dm ³ SO ₂ on 300 dm ³ /40 °C/1 cycle
Thermal stress	100 °C/168 h
Power-frequency withstand voltage	1.39 kV

Shocks

Specification	IEC 60068-2-27:2008-02
Pulse shape	Semi-sinusoidal
Acceleration	30g
Shock duration	18 ms
Test directions	X-, Y- and Z-axis (pos. and neg.)

Ambient conditions

Ambient temperature (operation)	-40 °C ... 100 °C (dependent on the derating curve)
Ambient temperature (storage/transport)	-40 °C ... 70 °C
Relative humidity (storage/transport)	30 % ... 70 %
Ambient temperature (assembly)	-5 °C ... 100 °C

Electrical tests

FRONT-MC 1,5/ 3-STF-3,81 - PCB connectors



1850864

<https://www.phoenixcontact.com/us/products/1850864>

Thermal test | Test group C

Specification	IEC 60512-5-1:2002-02
Tested number of positions	20

Insulation resistance

Specification	IEC 60512-3-1:2002-02
Insulation resistance, neighboring positions	> 5 MΩ

Air clearances and creepage distances |

Specification	IEC 60664-1:2007-04
Insulating material group	I
Comparative tracking index (IEC 60112)	CTI 600
Rated insulation voltage (III/3)	160 V
Rated surge voltage (III/3)	2.5 kV
minimum clearance value - non-homogenous field (III/3)	1.5 mm
minimum creepage distance (III/3)	2 mm
Rated insulation voltage (III/2)	160 V
Rated surge voltage (III/2)	2.5 kV
minimum clearance value - non-homogenous field (III/2)	1.5 mm
minimum creepage distance (III/2)	1.5 mm
Rated insulation voltage (II/2)	320 V
Rated surge voltage (II/2)	2.5 kV
minimum clearance value - non-homogenous field (II/2)	1.5 mm
minimum creepage distance (II/2)	1.6 mm

Packaging specifications

Type of packaging	packed in cardboard
-------------------	---------------------

1850864

<https://www.phoenixcontact.com/us/products/1850864>

Drawings

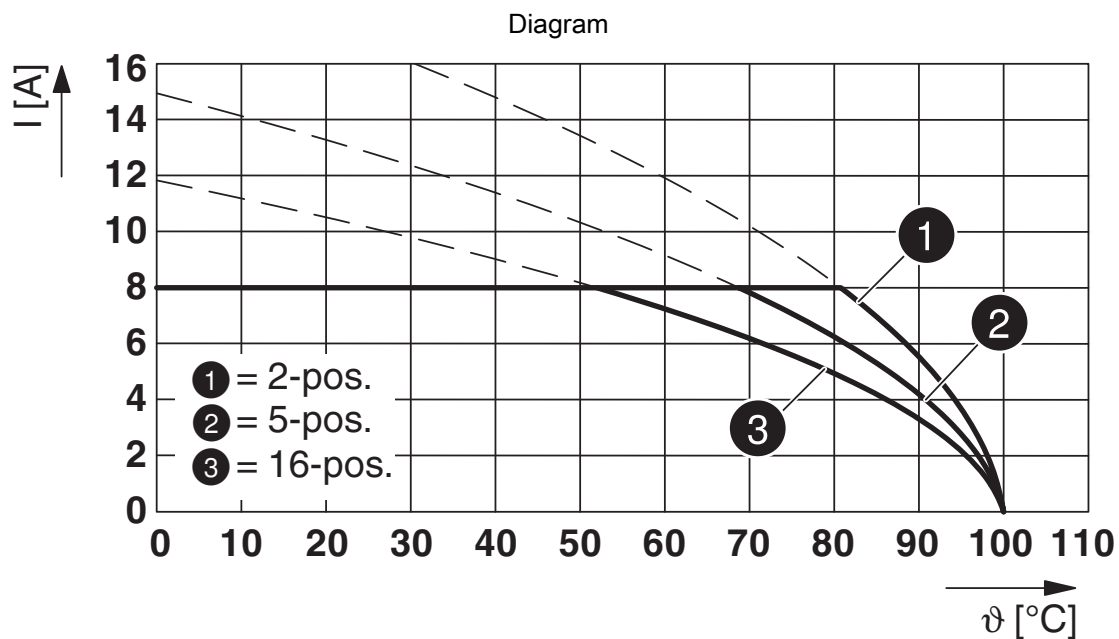

Type: FRONT-MC 1,5/...-STF-3,81 with MCD 1,5/...-G1F-3,81

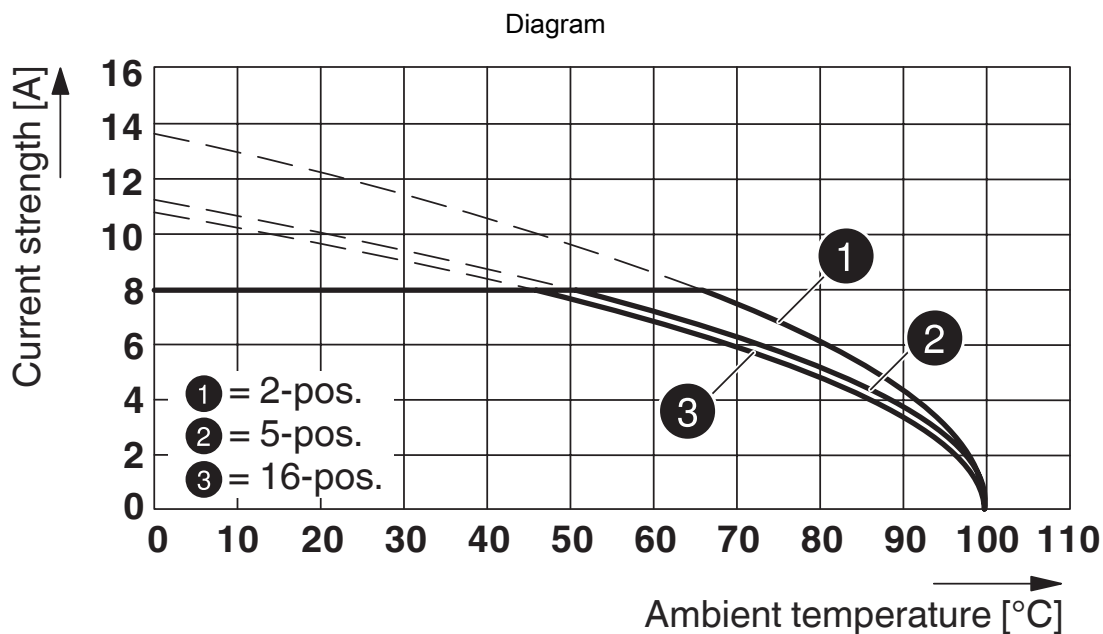

Type: FFRONT-MC 1,5/...-STF-3,81 with DFK-MC 1,5/...-GF-3,81

1850864

<https://www.phoenixcontact.com/us/products/1850864>

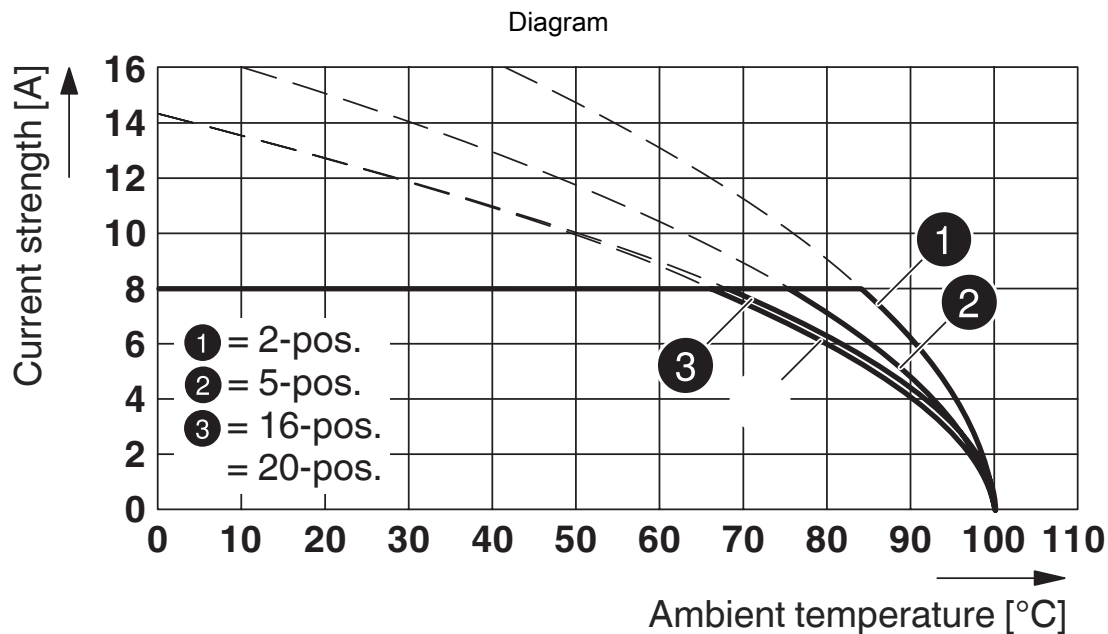

Type: FRONT-MC 1,5/...-STF-3,81 with MC 1,5/...-GF-3,81 P...THR

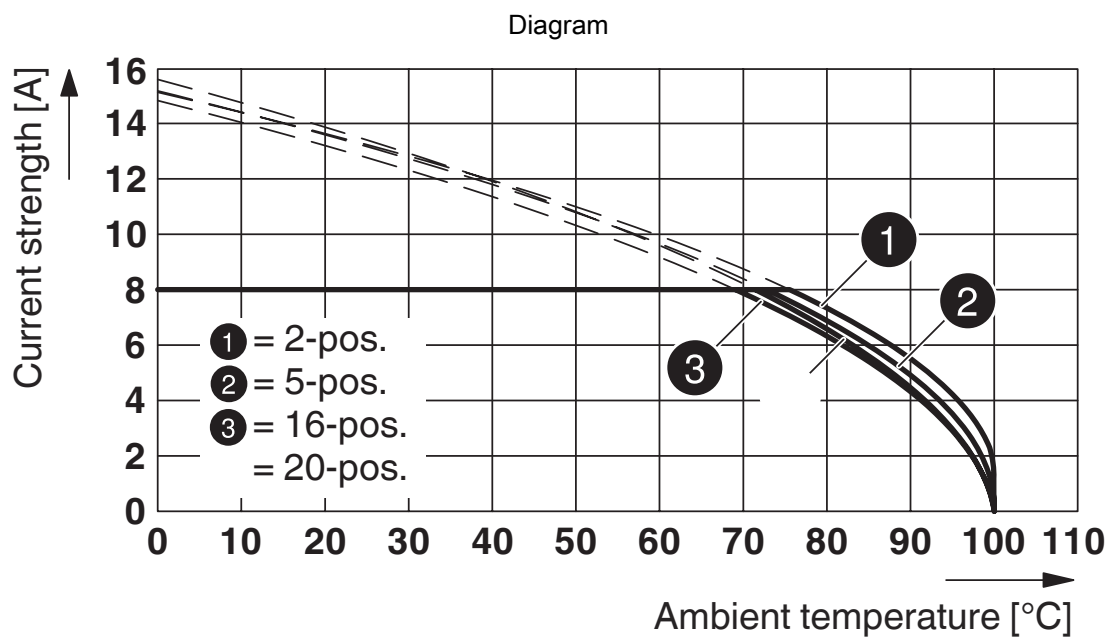

Type: FRONT-MC 1,5/...-STF-3,81 with MCV 1,5/...-GF-3,81 P... THR

FRONT-MC 1,5/ 3-STF-3,81 - PCB connectors



1850864

<https://www.phoenixcontact.com/us/products/1850864>

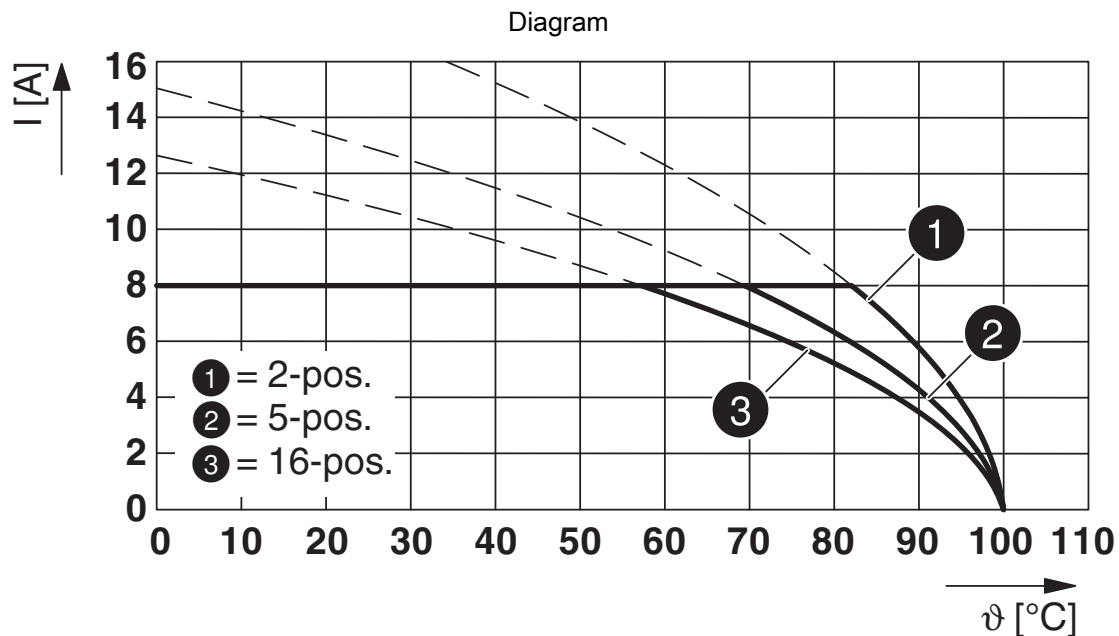

Type: FRONT-MC 1,5/...-STF-3,81 with MCDV 1,5/...-G1F-3,81

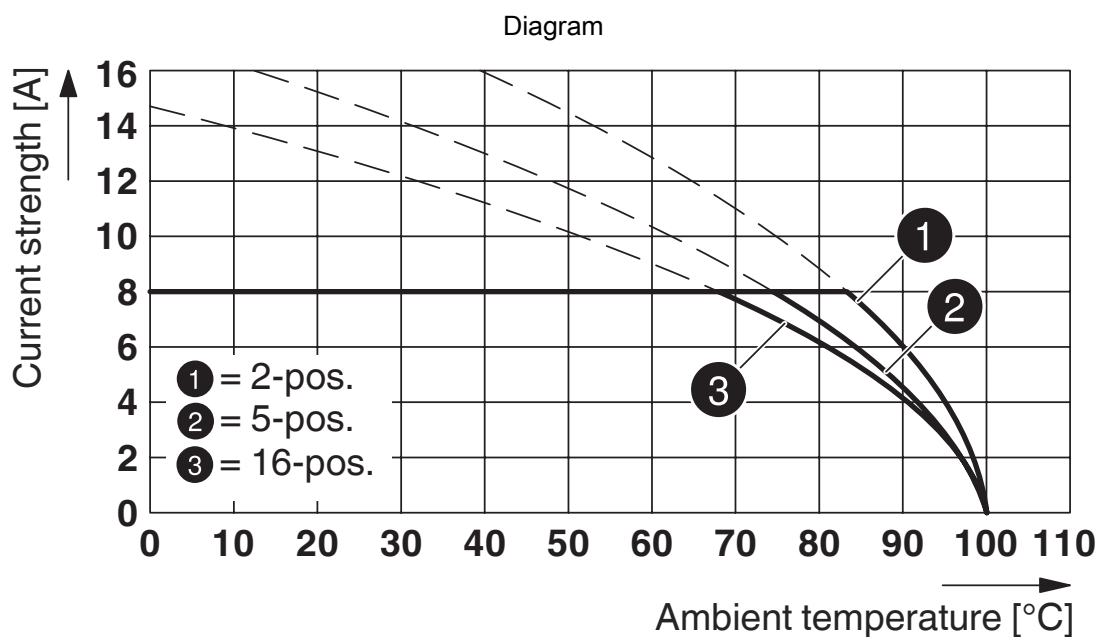

Type: FRONT-MC 1,5/...-STF-3,81 with IMC 1,5/...-STGF-3,81

FRONT-MC 1,5/ 3-STF-3,81 - PCB connectors



1850864

<https://www.phoenixcontact.com/us/products/1850864>

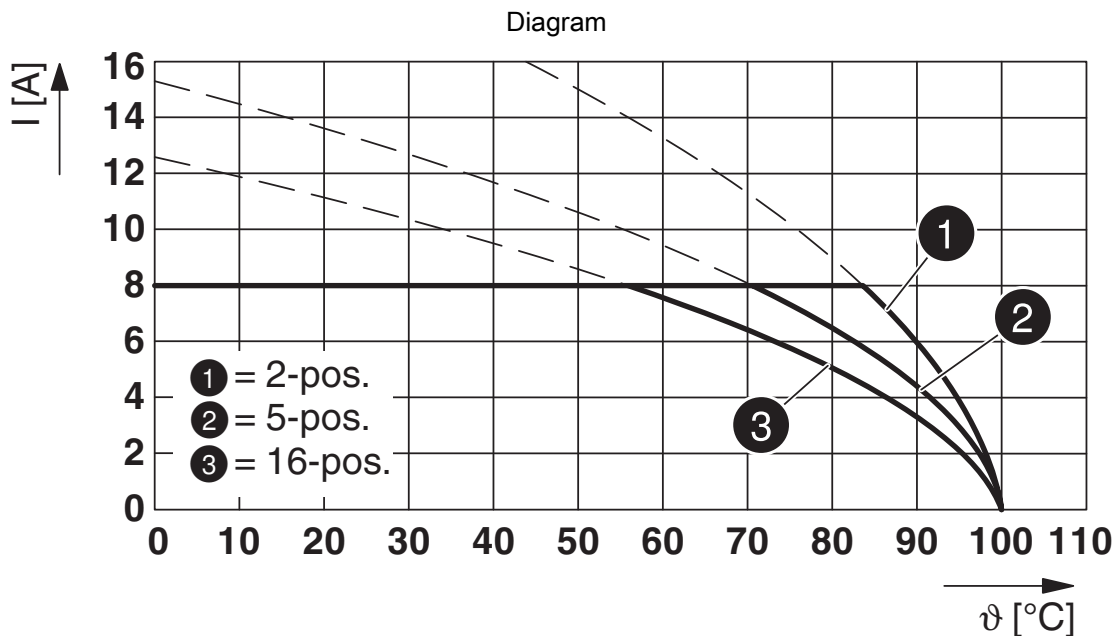

Type: FRONT-MC 1,5/...-STF-3,81 with MCDV 1,5/...-G1F-3,81

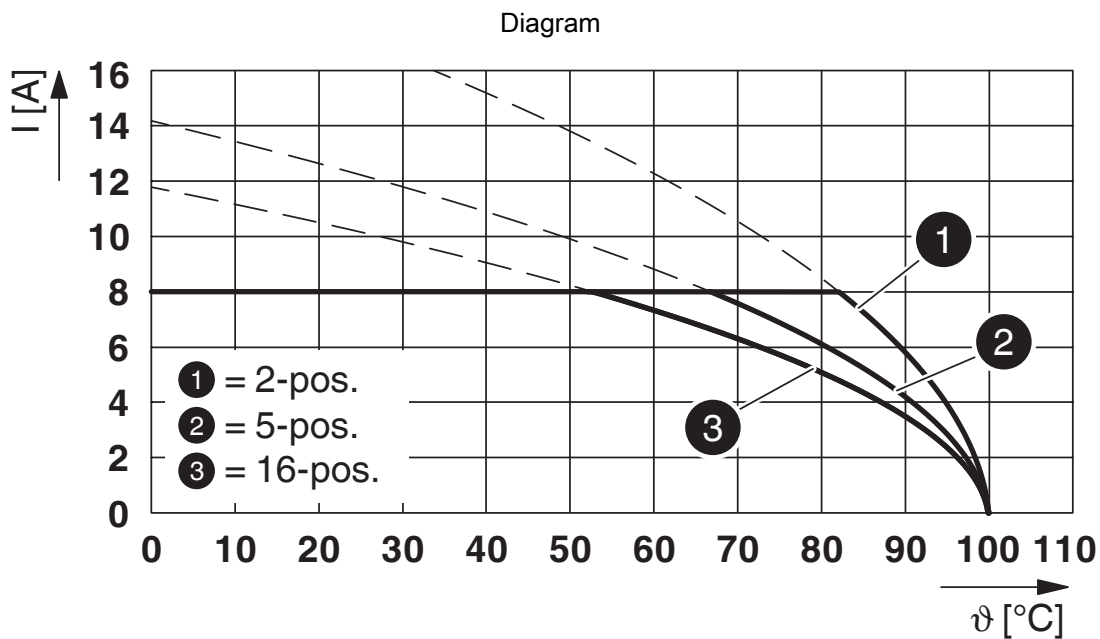

Type: FRONT-MC 1,5/...-ST-3,81 with MCD 1,5/...-GF-3,81

FRONT-MC 1,5/ 3-STF-3,81 - PCB connectors



1850864

<https://www.phoenixcontact.com/us/products/1850864>

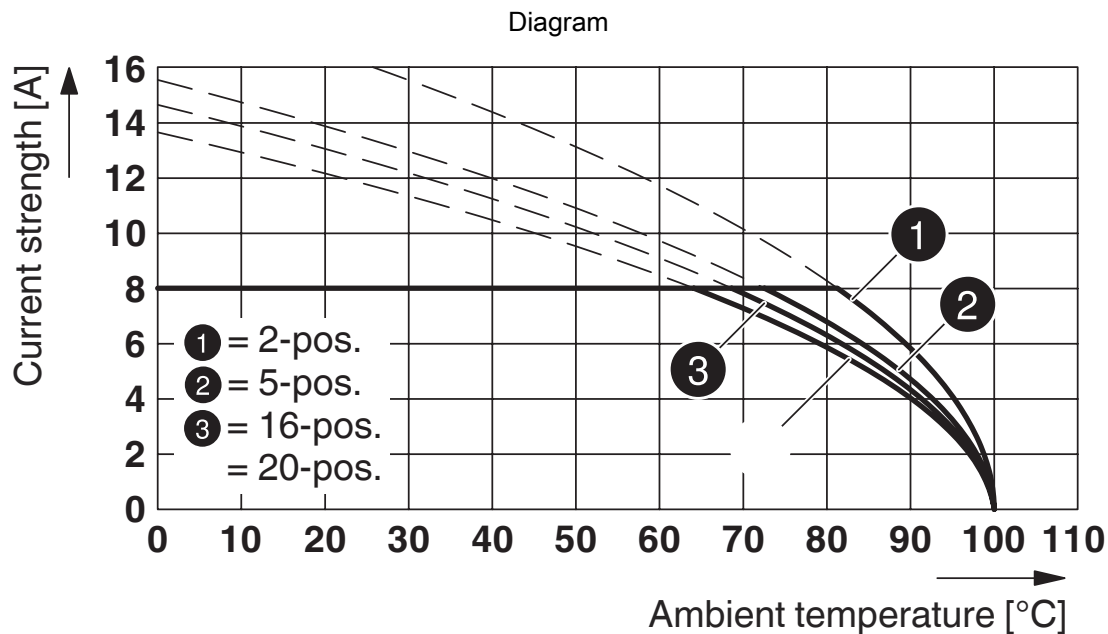

Type: FRONT-MC 1,5/...-STF-3,81 with MC 1,5/...-GF-3,81

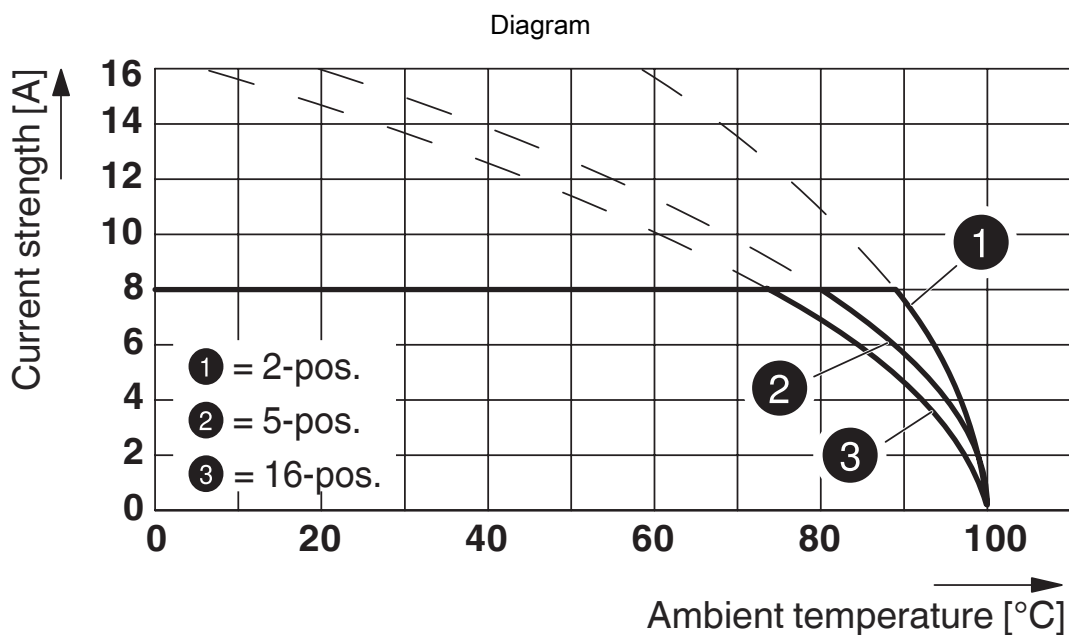

Type: FRONT-MC 1,5/...-STF-3,81 with SMC 1,5/...-GF-3,81

FRONT-MC 1,5/ 3-STF-3,81 - PCB connectors



1850864

<https://www.phoenixcontact.com/us/products/1850864>

Dimensional drawing

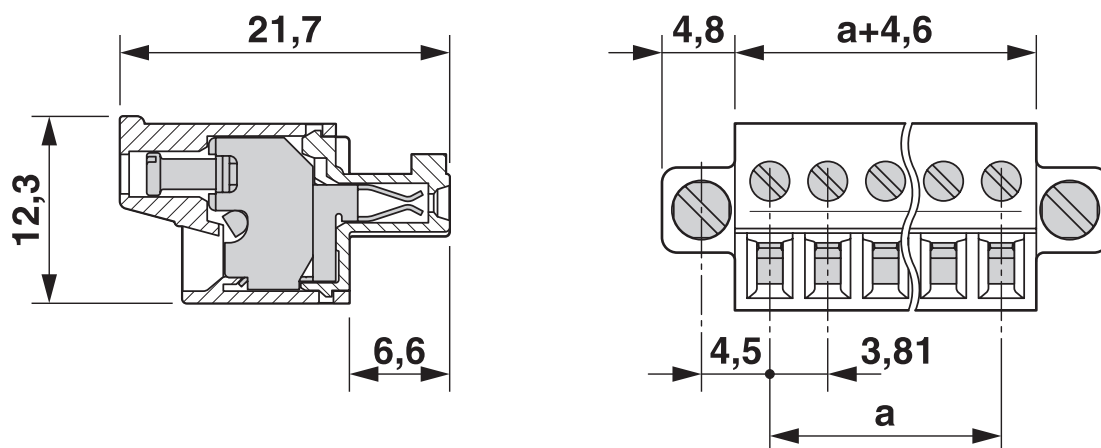

Diagram

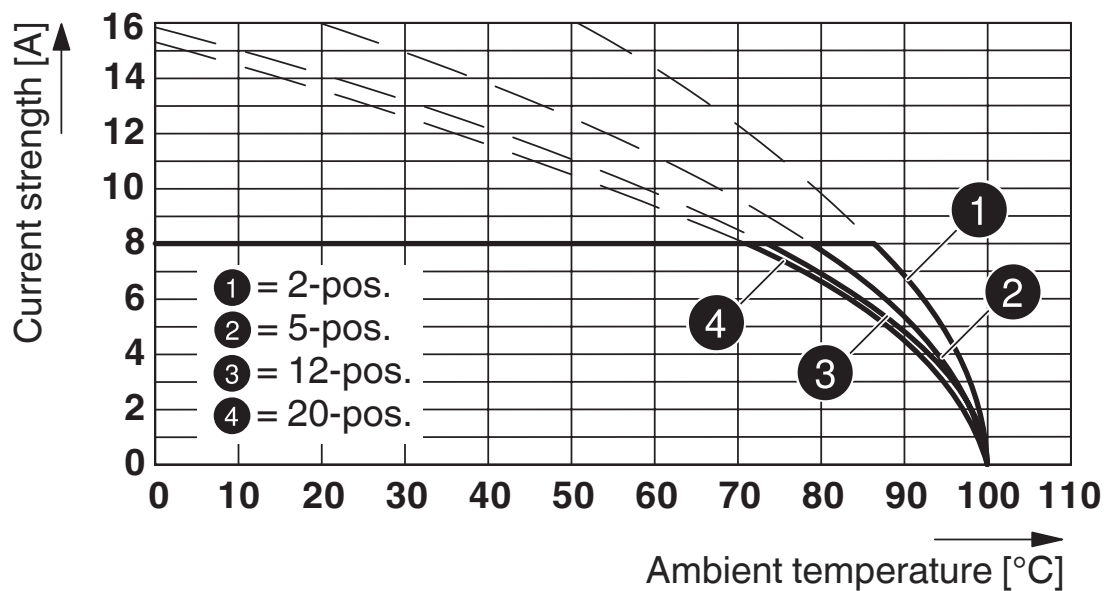

Type: FRONT-MC 1,5/...-STF-3,81 with MCV 1,5/...-GF-3,81

FRONT-MC 1,5/ 3-STF-3,81 - PCB connectors



1850864

<https://www.phoenixcontact.com/us/products/1850864>

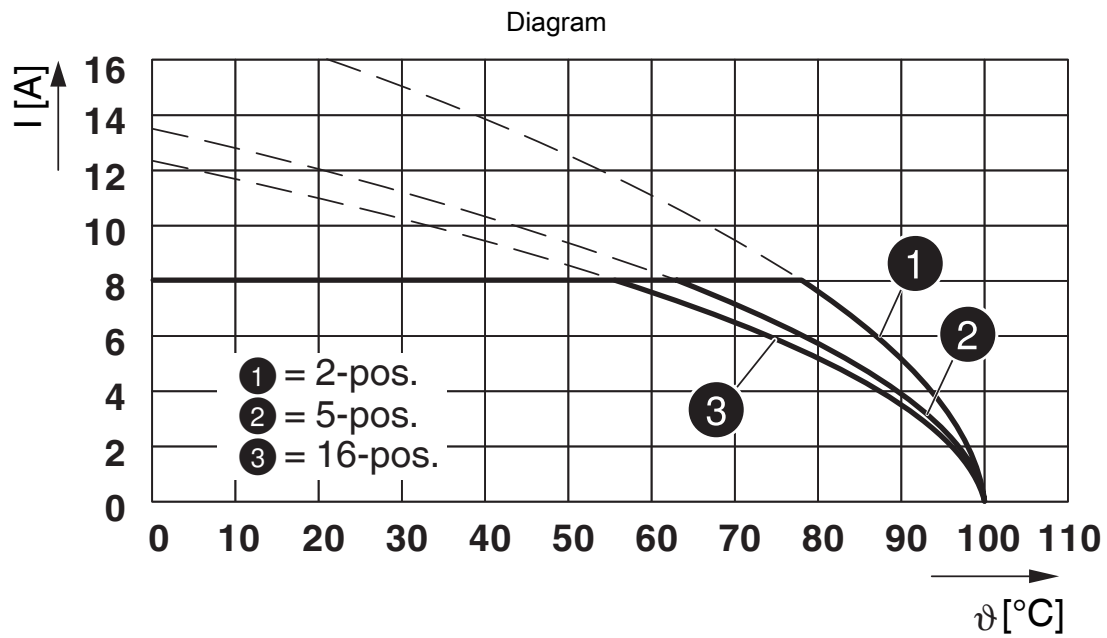

Type: FRONT-MC 1,5/...-STF-3,81 with MCVU 1,5/...-GFD-3,81

FRONT-MC 1,5/ 3-STF-3,81 - PCB connectors



1850864

<https://www.phoenixcontact.com/us/products/1850864>

Classifications

ECLASS

ECLASS-11.0	27460202
ECLASS-12.0	27460202
ECLASS-13.0	27460202

ETIM

ETIM 9.0	EC002638
----------	----------

UNSPSC

UNSPSC 21.0	39121400
-------------	----------

FRONT-MC 1,5/ 3-STF-3,81 - PCB connectors



1850864

<https://www.phoenixcontact.com/us/products/1850864>

Environmental product compliance

EU RoHS

Fulfills EU RoHS substance requirements	Yes, No exemptions
-----------------------------------------	--------------------

China RoHS

Environment friendly use period (EFUP)	EFUP-E
	No hazardous substances above the limits

EU REACH SVHC

REACH candidate substance (CAS No.)	No substance above 0.1 wt%
-------------------------------------	----------------------------

FRONT-MC 1,5/ 3-STF-3,81 - PCB connectors



1850864

<https://www.phoenixcontact.com/us/products/1850864>

Accessories

SZS 0,4X2,5 VDE - Screwdriver

1205037

<https://www.phoenixcontact.com/us/products/1205037>



Screwdriver, slot-headed, VDE insulated, size: 0.4 x 2.5 x 80 mm, 2-component grip, with non-slip grip

SK 3,81/2,8:FORTL.ZAHLEN - Marker card

0804109

<https://www.phoenixcontact.com/us/products/0804109>



Marker card, Sheet, white, labeled, horizontal: consecutive numbers 1 ... 10, 11 .. 20, etc. up to 91 ... (99)100, mounting type: adhesive, for terminal block width: 3.81 mm, lettering field size: 3.81 x 2.8 mm, Number of individual labels: 14

FRONT-MC 1,5/ 3-STF-3,81 - PCB connectors



1850864

<https://www.phoenixcontact.com/us/products/1850864>

B-STIFT - Marker pen

1051993

<https://www.phoenixcontact.com/us/products/1051993>



Marker pen, for manual labeling of unprinted Zack strips, smear-proof and waterproof, line thickness 0.5 mm

EBPL 2-3,81 - Insertion bridge

1733495

<https://www.phoenixcontact.com/us/products/1733495>



Insertion bridge for plugs featuring a screw connection with a 3.81 mm pitch

FRONT-MC 1,5/ 3-STF-3,81 - PCB connectors



1850864

<https://www.phoenixcontact.com/us/products/1850864>

MCV 1,5/ 3-GF-3,81 P14 THR - PCB header

1707227

<https://www.phoenixcontact.com/us/products/1707227>

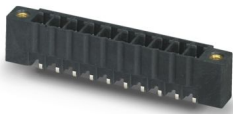

PCB headers, nominal cross section: 1.5 mm², color: black, nominal current: 8 A, rated voltage (III/2): 160 V, contact surface: Tin, contact connection type: Pin, number of potentials: 3, number of rows: 1, number of positions: 3, number of connections: 3, product range: MCV 1,5/..-GF-THR, pitch: 3.81 mm, mounting: THR soldering / wave soldering, pin layout: Linear pinning, solder pin [P]: 1.4 mm, number of solder pins per potential: 1, plug-in system: COMBICON MC 1,5, Pin connector pattern alignment: Standard, locking: Screw locking mechanism, mounting: Threaded flange, type of packaging: packed in cardboard, For user information and design recommendations for through-hole reflow technology, go to: Downloads

MCV 1,5/ 3-GF-3,81 P26 THR - PCB header

1707641

<https://www.phoenixcontact.com/us/products/1707641>

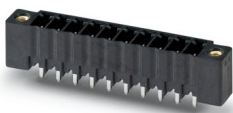

PCB headers, nominal cross section: 1.5 mm², color: black, nominal current: 8 A, rated voltage (III/2): 160 V, contact surface: Tin, contact connection type: Pin, number of potentials: 3, number of rows: 1, number of positions: 3, number of connections: 3, product range: MCV 1,5/..-GF-THR, pitch: 3.81 mm, mounting: THR soldering / wave soldering, pin layout: Linear pinning, solder pin [P]: 2.6 mm, number of solder pins per potential: 1, plug-in system: COMBICON MC 1,5, Pin connector pattern alignment: Standard, locking: Screw locking mechanism, mounting: Threaded flange, type of packaging: packed in cardboard, For user information and design recommendations for through-hole reflow technology, go to: Downloads

Phoenix Contact 2024 © - all rights reserved

<https://www.phoenixcontact.com>

Phoenix Contact USA
586 Fulling Mill Road
Middletown, PA 17057, United States
(+717) 944-1300
info@phoenixcon.com