

Data Sheet | Item Number: 250-705

Double-deck PCB terminal block; push-button; 1.5 mm²; Pin spacing 5 mm; 10-pole;
Push-in CAGE CLAMP®; agate gray

<https://www.wago.com/250-705>

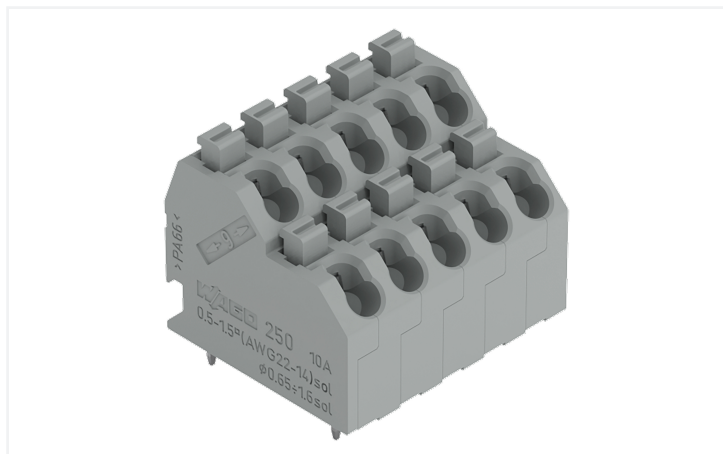

Color: ■ agate gray

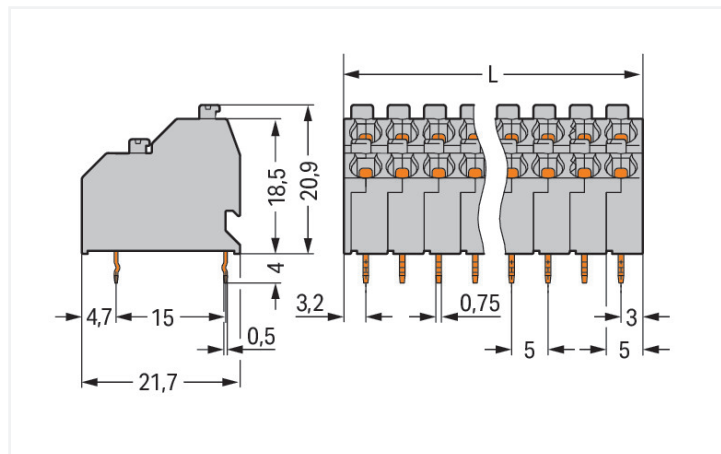

Dimensions in mm

$L = ((\text{Polzahl} / 2) \times \text{Rastermaß}) + 1,2 \text{ mm}$

PCB terminal block, 250 Series, 45° conductor entry to board

Easily, quickly and safely connect conductors with this PCB terminal block (item number 250-705). You can rely on trusted safety with these PCB terminal blocks, perfect for a wide range of applications when designing your devices. Strip lengths must be 9 mm when connecting conductors to this PCB terminal block. This product features one conductor terminal and utilizes Push-in CAGE CLAMP®. Push-in CAGE CLAMP® connection technology is ideal for connecting all conductor types. Solid and fine-stranded conductors with ferrules can be inserted without needing to use any tools—all thanks to its pluggable design. The item's dimensions are (26.2 x 24.9 x 21.7) mm (width x height x depth). Depending on the conductor type, this PCB terminal block is suitable for conductor cross sections ranging from 0.5 mm² to 1.5 mm².

The contact surface is coated with tin. This PCB terminal block is operated with a push-button. The PCB terminal block is designed for THT soldering. Insert the conductor at a 45° angle.

Notes

Variants:

Other pole numbers
Other colors
Direct marking
Other versions (or variants) can be requested from WAGO Sales or configured at <https://configurator.wago.com/>.

Electrical data

Ratings per	IEC/EN 60664-1		
Oversoltage category	III	III	II
Pollution degree	3	2	2
Nominal voltage	320 V	400 V	630 V
Rated impulse withstand voltage	4 kV	4 kV	4 kV
Rated current	10 A	10 A	10 A

Approvals per	UL 1059		
Use group	B	C	D
Rated voltage	300 V	-	300 V
Rated current	10 A	-	10 A

Approvals per	CSA		
	B	C	D
Use group	B	C	D
Rated voltage	300 V	-	300 V
Rated current	10 A	-	10 A

Connection Data

Clamping units	10
Total number of potentials	10
Number of connection types	1
Number of levels	2

Connection 1

Connection technology	Push-in CAGE CLAMP®
Actuation type	Push-button
Solid conductor	0.5 ... 1.5 mm ² / 20 ... 16 AWG
Fine-stranded conductor	0.75 ... 1.5 mm ²
Fine-stranded conductor; with insulated ferrule	0.5 ... 1 mm ²
Fine-stranded conductor; with uninsulated ferrule	0.5 ... 1 mm ²
Note (conductor cross-section)	Fine-stranded conductor 0.75 ... 1.5 mm ² (I max. 4 A) Fine-stranded conductor 0.5 mm ² (I max. 2 A)
Strip length	9 mm / 0.35 inches
Conductor connection direction to PCB	45 °
Pole number	10

Physical data

Pin spacing	5 mm / 0.197 inches
Width	26.2 mm / 1.031 inches
Height	24.9 mm / 0.98 inches
Height from the surface	20.9 mm / 0.823 inches
Depth	21.7 mm / 0.854 inches
Solder pin length	4 mm
Solder pin dimensions	0.5 x 0.75 mm
Drilled hole diameter	1.2 ^(-0.1 ... +0.1) mm

PCB contact

PCB contact	THT
Solder pin arrangement	over the entire terminal strip (in-line)
Number of solder pins per potential	1

Material data

Note (material data)	Information on material specifications can be found here
Color	agate gray
Material group	I
Insulation material (main housing)	Polyamide (PA66)
Flammability class per UL94	V0
Clamping spring material	Chrome-nickel spring steel (CrNi)
Contact material	Electrolytic copper (E _{Cu})
Contact Plating	Tin
Fire load	0.186 MJ
Weight	9.7 g

Environmental requirements

Limit temperature range	-60 ... +105 °C
-------------------------	-----------------

Commercial data

Product Group	4 (Printed Circuit Connectors)
PU (SPU)	108 (27) pcs
Packaging type	Box
Country of origin	CH
GTIN	4044918300957
Customs tariff number	85369010000

Product Classification

UNSPSC	39121409
eCl@ss 10.0	27-44-04-01
eCl@ss 9.0	27-44-04-01
ETIM 9.0	EC002643
ETIM 10.0	EC002643
ECCN	NO US CLASSIFICATION

Environmental Product Compliance

RoHS Compliance Status	Compliant, No Exemption
------------------------	-------------------------

Approvals / Certificates

General approvals



Approval	Standard	Certificate Name
CCA DEKRA Certification B.V.	EN 60947	NTR NL 7833/2
CCA DEKRA Certification B.V.	EN 60998	NTR NL-7705/1
CSA DEKRA Certification B.V.	C22.2	1132097
DEKRA DEKRA Certification B.V.	EN 60947-7-4	71-141963
KEMA/KEUR DEKRA Certification B.V.	EN 60947	2160584.18
KEMA/KEUR DEKRA Certification B.V.	EN 60998	71-124629
UL UL International Germany GmbH	UL 1059	E45172

Declarations of conformity and manufacturer's declarations

Approval	Standard	Certificate Name
EU-Declaration of Confor- mity WAGO GmbH & Co. KG	-	-
UK-Declaration of Confor- mity WAGO GmbH & Co. KG	-	-

Approvals for marine applications



Approval	Standard	Certificate Name
ABS American Bureau of Ship- ping	-	24-0095975-PDA
DNV DNV GL SE	-	TAE000016Z

Downloads

Environmental Product Compliance

Compliance Search	
Environmental Product Compliance 250-705	↓

Documentation

Additional Information			
Technical Section	03.04.2019	pdf 2027.26 KB	↓

CAD/CAE-Data

CAD data
2D/3D Models 250-705 ↓

CAE data
ZUKEN Portal 250-705 ↓

PCB Design

Symbol and Footprint via SamacSys 250-705 ↓
Symbol and Footprint via Ultra Librarian 250-705 ↓

1 Compatible Products

1.1 Optional Accessories

1.1.1 Marking

1.1.1.1 Marking strip



Item No.: 210-332/500-202

Marking strips; as a DIN A4 sheet; MARKED; 1-16 (160x); Height of marker strip: 3 mm; Strip length 182 mm; Horizontal marking; Self-adhesive; white



Item No.: 210-332/500-205

Marking strips; as a DIN A4 sheet; MARKED; 1-32 (80x); Height of marker strip: 3 mm; Strip length 182 mm; Horizontal marking; Self-adhesive; white



Item No.: 210-332/500-204

Marking strips; as a DIN A4 sheet; MARKED; 17-32 (160x); Height of marker strip: 3 mm; Strip length 182 mm; Horizontal marking; Self-adhesive; white



Item No.: 210-332/500-206

Marking strips; as a DIN A4 sheet; MARKED; 33-48 (160x); Height of marker strip: 3 mm; Strip length 182 mm; Horizontal marking; Self-adhesive; white

1.1.2 Test and measurement

1.1.2.1 Testing accessories



Item No.: 210-136

Test plug; 2 mm Ø; with 500 mm cable; red

1.1.3 Tool

1.1.3.1 Operating tool



Item No.: 210-719

Operating tool; Blade: 2.5 x 0.4 mm; with a partially insulated shaft



Item No.: 210-647

Operating tool; Blade: 2.5 x 0.4 mm; with a partially insulated shaft; multicoloured

Installation Notes

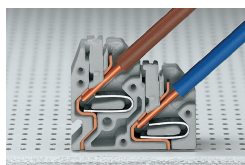

Space-saving wiring – push-in termination of solid conductors.

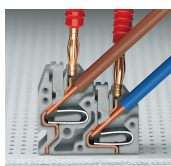

Testing with 2 mm Ø test plug – touch contact.

Conductor termination

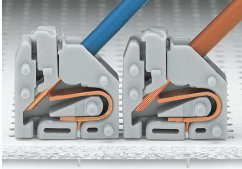

Inserting solid conductors via push-in termination.
Inserting fine-stranded conductors via push-buttons, 250 Series – 3.5 mm pin spacing.

Conductor termination

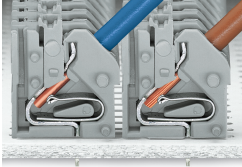

Space-saving wiring, 250 Series – 5 mm pin spacing.

Testing

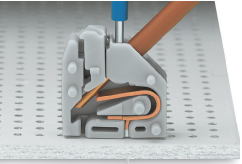

Testing with 11 mm Ø test pin, on the conductor, 250 Series – 2.5 ... 3.5 mm pin spacing.

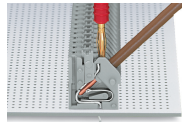

Testing with 2 mm Ø test plug, touch contact, 250 Series – 5 mm pin spacing.

Marking

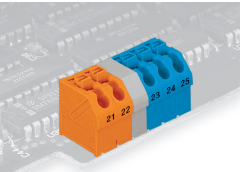

Labeling via self-adhesive strips or direct marking. Mixed-color terminal strips (with or without spacer) are available upon request.

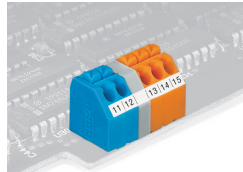

Labeling via self-adhesive strips or direct marking. Mixed-color terminal strips (with or without spacer) are available upon request.