

**Data Sheet | Item Number: 221-485**

Splicing connector with levers; for all conductor types; for Ex e applications; max. 4 mm<sup>2</sup>; 5-conductor; transparent housing; Operating temperature (max.): 105 °C; 4,00 mm<sup>2</sup>; transparent



<https://www.wago.com/221-485>



Color:  transparent



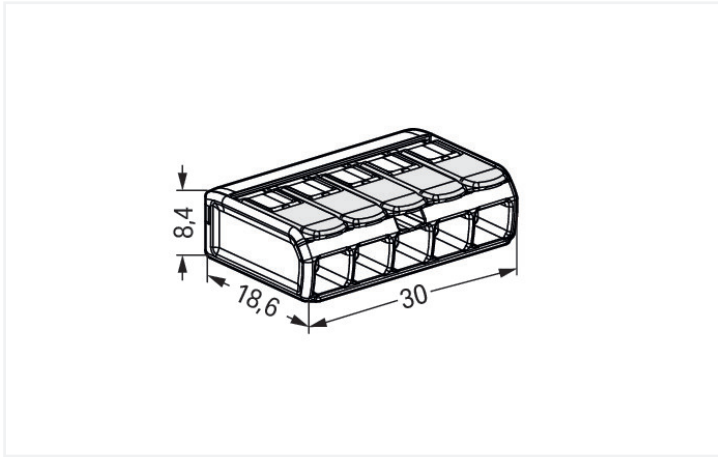

Dimensions in mm

## Splicing connector with levers, 221 Series, lever

Our splicing connector with levers (item number 221-485) is designed for seamless electrical installations. From wiring intercom systems to installing electrical ovens, connecting different conductor types is quick and simple with WAGO's compact 221 Series splicing connector, which allows you to quickly and safely connect different types of conductors. Conductors should only be connected to splicing connector with levers if their strip length is 11 mm. Featuring conductor terminals along with CAGE CLAMP®, this product outperforms the competition. Our tried-and-tested universal connection known as CAGE CLAMP® is the industry standard for connection technology and electrical interconnections. The dimensions are (30 x 8.4 x 18.6) mm (width x height x depth). Depending on the conductor type, splicing connector with levers is suitable for conductor cross sections ranging from 0.2 mm<sup>2</sup> to 4 mm<sup>2</sup>.

WAGO's 221 Series Splicing Connector with levers impresses with its innovative design for different conductor cross-sections. That's why WAGO's lever-equipped splicing connector holds a unique trademark within electrical interconnection technology. The flat levers, which fit seamlessly into the 221's base, act like a cast when closed and can be positioned neatly in any housing without disturbing edges. Due to the wide design of each lever, they can all be operated perfectly without tools for convenient conductor terminations. The transparent housing displays robust technology and enables immediate visual inspection for the correct contact of solid, stranded and fine-stranded conductors. Resembling piano keys, the levers' design perfectly combines the functional and aesthetic connection technology "Made by WAGO." This product is designed for specific Ex applications (please refer to the product datasheet).

## Notes

General safety information

**NOTICE: Observe installation and safety instructions!**

- **Only to be used by electricians!**
- Do not work under voltage/load!
- Use only for proper use!
- Observe national regulations/standards/guidelines!
- Observe technical specifications for the products!
- Observe the number of permissible potentials!
- Do not use damaged/dirty components!
- Observe conductor types, cross-sections and strip lengths!
- Insert conductor until it hits the product's backstop!
- Use original accessories!

**To be sold only with installation instructions!**

Safety Information

The permissible operating voltage of the connector with carrier (440 V or 275 V) depends on the mounting type.

Safety information 2

Only approved in conjunction with a mounting carrier (221-501). Other carriers are possible, see certificate/file. The connectors must be installed in an enclosure meeting the requirements of a recognized protection type per EN 60079-0, GB/T 3836.1 Section 1 or EN 60079-31, GB/T 3836.31. When installing the connectors in an enclosure of protection type "e" (increased safety per EN 60079-7, GB/T 3836.3), the clearances and creepage distances of Table 2 for this standard must be observed. See point 1 for the use of accessories. The connectors can be used both in Group II and Group I, as the standard requirements are identical in this case.

The use of these components requires a new assessment by a notified certification agency.

## Electrical data

Approvals per	UL 60079		
Use group	B	C	D
Rated voltage	-	440 V	-
Rated current	-	20 A	-

## Ex information

Ratings per	ATEX: PTB 18 ATEX 1019 U / IECEx: PTB 18.0045U (Ex eb IIC Gb)
Rated voltage EN (Ex e II)	440 V
Rated current (Ex e II)	32 A

## General information

Wiring direction	Side-entry wiring
------------------	-------------------

## Connection Data

Clamping units	5
Total number of potentials	1

## Connection 1

Connection technology	CAGE CLAMP®
Actuation type	Lever
Connectable conductor materials	Copper
Nominal cross-section	4 mm <sup>2</sup> / 12 AWG
Solid conductor	0.2 ... 4 mm <sup>2</sup> / 24 ... 12 AWG
Stranded conductor	0.2 ... 4 mm <sup>2</sup> / 24 ... 12 AWG
Fine-stranded conductor	0.14 ... 4 mm <sup>2</sup> / 24 ... 12 AWG
Strip length	11 mm / 0.43 inches
Wiring direction	Side-entry wiring

## Physical data

Width	30 mm / 1.181 inches
Height	8.4 mm / 0.327 inches
Depth	18.6 mm / 0.732 inches

## Material data

Note (material data)	<a href="#">Information on material specifications can be found here</a>
Color	transparent
Material group	IIIa
Insulation material (main housing)	Polycarbonate (PC)
Flammability class per UL94	V2
Fire load	0.061 MJ
Actuator color	light gray
Weight	4.4 g

## Environmental requirements

Ambient temperature (storage)	-40 ... +60 °C
Continuous operating temperature	-55 ... +105 °C

### Commercial data

PU (SPU)	250 (25) pcs
Packaging type	Box
Country of origin	DE
GTIN	4055143837330
Customs tariff number	85369010000

### Product Classification

UNSPSC	39121409
eCl@ss 10.0	27-14-11-04
eCl@ss 9.0	27-14-11-04
ETIM 9.0	EC000446
ETIM 10.0	EC000446
ECCN	NO US CLASSIFICATION

### Environmental Product Compliance

RoHS Compliance Status	Compliant, No Exemption
------------------------	-------------------------

### Approvals / Certificates

#### General approvals



Approval	Standard	Certificate Name
CCA DEKRA Certification B.V.	EN 60998	NTR NL-7990
cULus_Listed_667F Underwriters Laboratories Inc.	UL 486C	E69654
ENEC 05 DEKRA Certification B.V.	EN 60998	71-152284

#### Declarations of conformity and manufacturer's declarations

Approval	Standard	Certificate Name
ATEX-Attestation of Con- formity WAGO GmbH & Co. KG	-	-
EU-Declaration of Confor- mity WAGO GmbH & Co. KG	-	-
UK-Declaration of Confor- mity WAGO GmbH & Co. KG	-	-

#### Approvals for marine applications



Approval	Standard	Certificate Name
LR Lloyds Register	EN 60998	LR2446364TA

#### Approvals for hazardous areas



Approval	Standard	Certificate Name
AEx Underwriters Laboratories Inc.	UL 60079	E185892 (AEx eb IIC resp. Ex eb IIC)
ATEX Physikalisch Technische Bundesanstalt	EN IEC 60079-0	PTB 18 ATEX 1019 U (II 2 G Ex eb IIC Gb, I M 2 Ex eb I Mb)
CCC CNEX	GB/T 3836.3	2020312313000184 (Ex eb IIC Gb, Ex eb I Mb)
IECEX Physikalisch Technische Bundesanstalt	IEC 60079-0	IECEX PTB 18.0045U (Ex eb IIC Gb, Ex eb I Mb)
INMETRO TÜV Rheinland do Brasil Ltda.	IEC 60079	TÜV 19.1781 U



## Downloads

### Environmental Product Compliance

Compliance Search
Environmental Product Compliance 221-485 



## Documentation

System Description		
System Description 221-482, 221-483, 221-485	pdf 1151.51 KB	

Bid Text			
221-485	21.05.2019	xml 4.09 KB	
221-485	21.05.2019	docx 16.02 KB	
ausschreiben.de 221-485			

## CAD/CAE-Data

CAD data	
2D/3D Models 221-485	

CAE data	
EPLAN Data Portal 221-485	
ZUKEN Portal 221-485	

## 1 Compatible Products

### 1.1 Optional Accessories

#### 1.1.1 Mounting adapter

##### 1.1.1.1 Mounting accessories



**Item No.: 221-500/000-006**

Mounting carrier; 221 Series - 4 mm<sup>2</sup>; for DIN-35 rail mounting/screw mounting; blue

**Item No.: 221-501**

Mounting carrier; for Ex applications; 221 Series - 4 mm<sup>2</sup>; for DIN-35 rail mounting/screw mounting; light gray

## Installation Notes

### Conductor termination

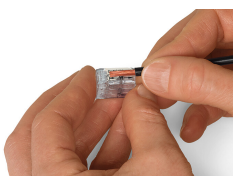

Strip conductor to 11 mm (0.43 inch).

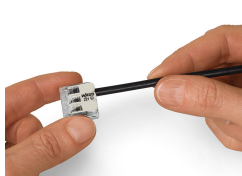

Then, lower the lever to close the clamp.

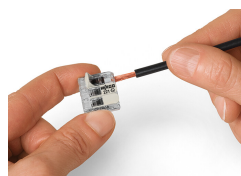

Termination: Lift the lever to open the clamping unit and insert a stripped conductor.

Installation

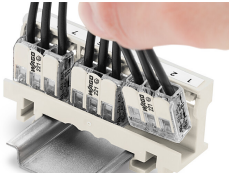

Inserting a connector into the mounting carrier.

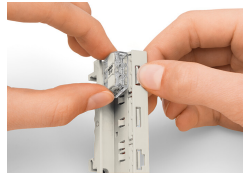

Removing a connector from the mounting carrier.

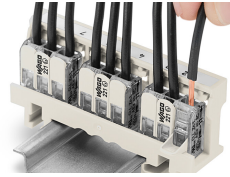

Removing a conductor.

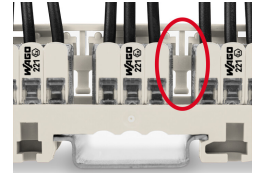

**Mounting type (440 V)**  
Using spacers between the connectors.

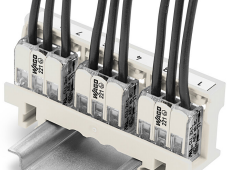

**Mounting type (440 V)**  
Vertical mounting on DIN-35 rail

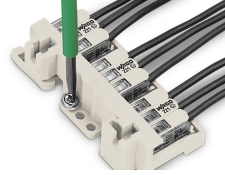

**Mounting type (440 V)**  
Horizontal screw mounting on a flat surface

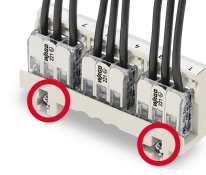

**Mounting type (440 V)**  
Mounting the carrier via non-conductive screws.

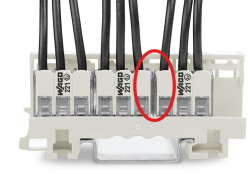

**Mounting type (275 V)**  
No spacers are used between the connectors.

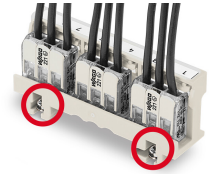

**Mounting type (275 V)**  
Mounting the carrier using conductive screws.

Testing

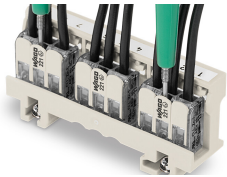

Easily test inserted connectors in the carrier – however they are mounted.