

# Data Sheet | Item Number: 831-3204

1-conductor male connector; Push-in CAGE CLAMP®; 10 mm²; Pin spacing 7.62 mm; 4-pole; 100% protected against mismatching; 10,00 mm²; light gray

<https://www.wago.com/831-3204>

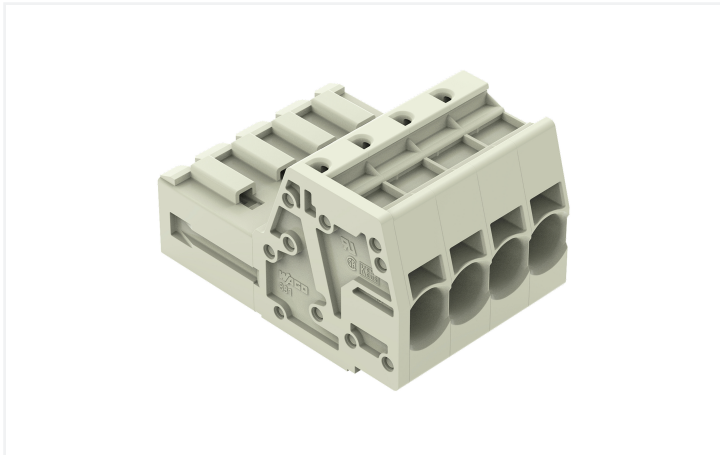

Color: ■ light gray

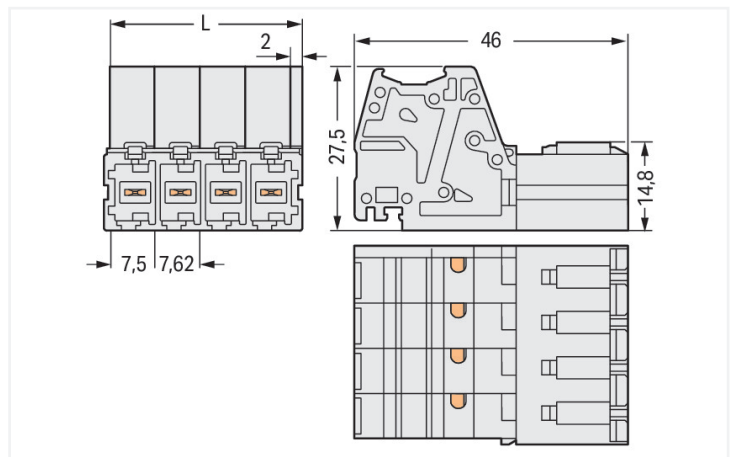
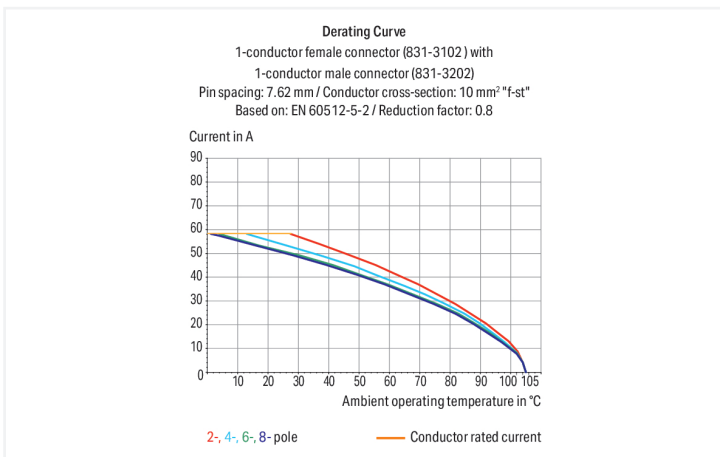
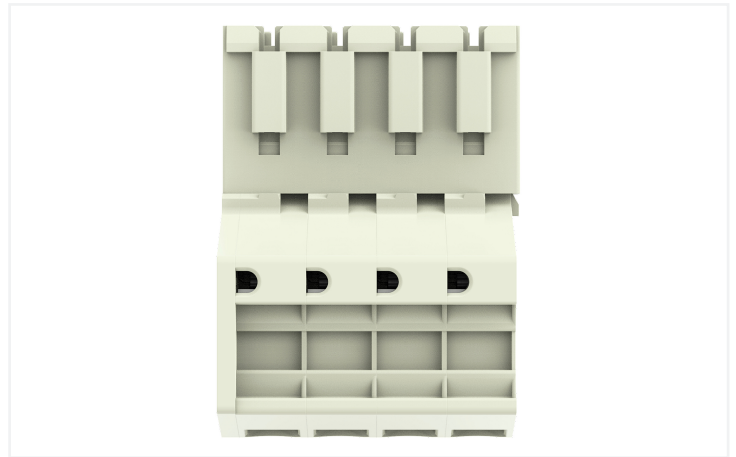
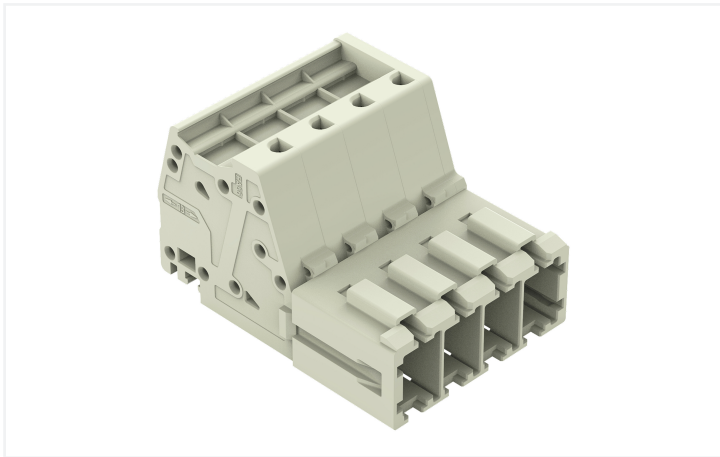

Male connector, 831 Series, operating tool

Enjoy fault-free electrical installations with this male connector (item number 831-3204). Ensure that the strip lengths are between 13 and 15 mm when connecting conductors to this male connector. This product features one conductor terminal and utilizes Push-in CAGE CLAMP®. Push-in CAGE CLAMP® connection technology is ideal for connecting all conductor types. It allows direct insertion of both solid and fine-stranded conductors with

ferrules without the need for tools—all thanks to its pluggable design. The item's dimensions are (32.36 x 27.5 x 46) mm (width x height x depth). This male connector is suitable for conductor cross sections ranging from 0.5 mm<sup>2</sup> to 10 mm<sup>2</sup>.

Tin is used for coating the contact surfaces.

Notes	
Safety Information	The MCS – MULTI CONNECTION SYSTEM includes connectors without breaking capacity in accordance with DIN EN 61984. When used as intended, these connectors must not be connected/disconnected when live or under load. When used as intended, these connectors must not be connected/disconnected when live or under load. The circuit design should ensure header pins, which can be touched, are not live when unmated.
Variants:	Other pole numbers Other versions (or variants) can be requested from WAGO Sales or configured at <a href="https://configurator.wago.com/">https://configurator.wago.com/</a> .

### Electrical data

Ratings per	IEC/EN 60664-1			Approvals per	UL 1059		
Overvoltage category	III	III	II	Use group	B	C	D
Pollution degree	3	2	2	Rated voltage	-	600 V	-
Nominal voltage	800 V	1000 V	1000 V	Rated current	-	42 A	-
Rated impulse withstand voltage	8 kV	8 kV	8 kV				
Rated current	41 A	41 A	41 A				

Approvals per	CSA		
Use group	B	C	D
Rated voltage	-	600 V	-
Rated current	-	41 A	-

### Connection Data

Clamping units	4	<b>Connection 1</b>	
Total number of potentials	4	Connection technology	Push-in CAGE CLAMP®
Number of connection types	1	Actuation type	Operating tool
Number of levels	1	Actuation direction 1	Operation parallel to conductor entry
		Solid conductor	0.5 ... 10 mm <sup>2</sup> / 20 ... 8 AWG
		Fine-stranded conductor	0.5 ... 10 mm <sup>2</sup> / 20 ... 8 AWG
		Fine-stranded conductor; with insulated ferrule	0.5 ... 6 mm <sup>2</sup>
		Fine-stranded conductor; with uninsulated ferrule	0.5 ... 6 mm <sup>2</sup>
		Strip length	13 ... 15 mm / 0.51 ... 0.59 inches
		Pole number	4
		Conductor entry direction to mating direction	0°

### Physical data

Pin spacing	7.62 mm / 0.3 inches
Width	32.36 mm / 1.274 inches
Height	27.5 mm / 1.083 inches
Depth	46 mm / 1.811 inches

### Mechanical data

Variable coding	Yes
Anti-rotation protection	Yes

### Plug-in connection

Contact type (pluggable connector)	Male connector/plug
Connector (connection type)	for conductor
Mismating protection	Yes

### Material data

Note (material data)	<a href="#">Information on material specifications can be found here</a>
Color	light gray
Material group	I
Insulation material (main housing)	Polyamide (PA66)
Flammability class per UL94	V0
Clamping spring material	Chrome-nickel spring steel (CrNi)
Contact material	Electrolytic copper (E <sub>Cu</sub> )
Contact Plating	Tin
Fire load	0.446 MJ
Weight	26.9 g

### Environmental requirements

Limit temperature range	-60 ... +105 °C
Processing temperature	-35 ... +60 °C

### Environmental Testing

Test specification: Railway applications – Rolling stock – Electronic equipment	DIN EN 50155 (VDE 0115-200):2022-06
Test procedure: Railway applications – Rolling stock equipment – Vibration and shock tests	DIN EN 61373 (VDE 0115-0106):2011-04
Spectrum/Mounting location	Service life test, Category 1, Class A/B
Functional test with noise-like oscillations	Test passed according to Section 8 of the standard
Frequency	f <sub>1</sub> = 5 Hz to f <sub>2</sub> = 150 Hz
Acceleration	0.101g (highest test level used for all axes)
Test duration per axis	10 min.
Test directions	X, Y and Z axes
Monitoring of contact faults and interruptions	Passed
Voltage drop measurement before and after each axis	Passed
Simulated service life test through increased levels of noise-like oscillations	Test passed according to Section 9 of the standard
Frequency	f <sub>1</sub> = 5 Hz to f <sub>2</sub> = 150 Hz
Acceleration	0.572g (highest test level used for all axes)
Test duration per axis	5 h
Test directions	X, Y and Z axes

**Environmental Testing**

Extended testing: Monitoring of contact faults and interruptions	Passed
Extended testing: Voltage drop measurement before and after each axis	Passed
Shock test	Test passed according to Section 10 of the standard
Shock pulse form	Half sine
Acceleration	5g (highest test level used for all axes)
Shock duration	30 ms
Number of shocks (per axis)	3 pos. und 3 neg.
Test directions	X, Y and Z axes
Extended testing: Monitoring of contact faults and interruptions	Passed
Extended testing: Voltage drop measurement before and after each axis	Passed
Vibration and shock stress for rolling stock equipment	Passed

**Commercial data**

Product Group	3 (Multi Conn. System)
PU (SPU)	24 pcs
Packaging type	Box
Country of origin	PL
GTIN	4066966835298
Customs tariff number	85366930000

**Product Classification**

UNSPSC	39121409
eCl@ss 10.0	27-14-11-06
eCl@ss 9.0	27-14-11-06
ETIM 9.0	EC001284
ETIM 10.0	EC001284
ECCN	NO US CLASSIFICATION

**Environmental Product Compliance**

RoHS Compliance Status	Compliant, No Exemption
------------------------	-------------------------

**Approvals / Certificates**

**General approvals**

**Declarations of conformity and manufacturer's declarations**



Approval	Standard	Certificate Name
CB DEKRA Certification B.V.	IEC 61984	NL-61360/M1
CSA DEKRA Certification B.V.	C22.2	1466354
KEMA/KEUR DEKRA Certification B.V.	EN 61984	71-116057
UR Underwriters Laboratories Inc.	UL 1059	UL-US-2426356-0

Approval	Standard	Certificate Name
Railway WAGO GmbH & Co. KG	-	Railway Ready

Approvals for marine applications



Approval	Standard	Certificate Name
LR Lloyds Register	IEC 61984	96/20035 (E5)

Downloads

Environmental Product Compliance

Compliance Search	
Environmental Product Compliance 831-3204	<a href="#">↓</a>

Documentation

Additional Information			
Technical Section	03.04.2019	pdf 2027.26 KB	<a href="#">↓</a>

CAD/CAE-Data

CAD data	
2D/3D Models 831-3204	<a href="#">↓</a>

CAE data	
EPLAN Data Portal 831-3204	<a href="#">↓</a>
ZUKEN Portal 831-3204	<a href="#">↓</a>

1 Compatible Products

1.1 System counterpart

1.1.1 Female connector/socket



**Item No.: 831-3104**  
1-conductor female connector; Push-in CAGE CLAMP®; 10 mm²; Pin spacing 7.62 mm; 4-pole; 100% protected against mismatching; 10,00 mm²; light gray



**Item No.: 831-3104/000-9037**  
1-conductor female connector; Push-in CAGE CLAMP®; 10 mm²; Pin spacing 7.62 mm; 4-pole; 100% protected against mismatching; direct marking; 10,00 mm²; light gray



**Item No.: 831-3104/135-000**  
1-conductor female connector; Push-in CAGE CLAMP®; 10 mm²; Pin spacing 7.62 mm; 4-pole; 100% protected against mismatching; Gripping plate; 10,00 mm²; light gray



**Item No.: 831-3104/037-000**  
1-conductor female connector; Push-in CAGE CLAMP®; 10 mm²; Pin spacing 7.62 mm; 4-pole; 100% protected against mismatching; Lateral locking levers; 10,00 mm²; light gray



**Item No.: 831-3104/037-9037**  
1-conductor female connector; Push-in CAGE CLAMP®; 10 mm²; Pin spacing 7.62 mm; 4-pole; 100% protected against mismatching; Lateral locking levers; direct marking; 10,00 mm²; light gray



**Item No.: 831-3524**  
THT female header; angled; Pin spacing 7.62 mm; 4-pole; 100% protected against mismatching; 1.0 x 1.2 mm solder pin; light gray



**Item No.: 831-3504**  
THT female header; straight; Pin spacing 7.62 mm; 4-pole; 100% protected against mismatching; 1.0 x 1.2 mm solder pin; light gray

## 1.2 Optional Accessories

### 1.2.1 Coding

#### 1.2.1.1 Coding



**Item No.: 831-500**

Coding pin carrier with six coding pins; orange

### 1.2.2 Installation

#### 1.2.2.1 Snap-in frame



**Item No.: 831-304**

Snap-in frame; for male connectors; 1 part; Pin spacing 7.62 mm; 4-pole; light gray

### 1.2.3 Marking

#### 1.2.3.1 Marker

**Item No.: 2009-145/000-006**

Mini-WSB Inline; for Smart Printer; 1700 pieces on roll; stretchable 5 - 5.2 mm; plain; snap-on type; blue

**Item No.: 2009-145/000-007**

Mini-WSB Inline; for Smart Printer; 1700 pieces on roll; stretchable 5 - 5.2 mm; plain; snap-on type; gray

**Item No.: 2009-145/000-023**

Mini-WSB Inline; for Smart Printer; 1700 pieces on roll; stretchable 5 - 5.2 mm; plain; snap-on type; green

**Item No.: 2009-145/000-012**

Mini-WSB Inline; for Smart Printer; 1700 pieces on roll; stretchable 5 - 5.2 mm; plain; snap-on type; orange

**Item No.: 2009-145/000-005**

Mini-WSB Inline; for Smart Printer; 1700 pieces on roll; stretchable 5 - 5.2 mm; plain; snap-on type; red

**Item No.: 2009-145/000-024**

Mini-WSB Inline; for Smart Printer; 1700 pieces on roll; stretchable 5 - 5.2 mm; plain; snap-on type; violet

**Item No.: 2009-145**

Mini-WSB Inline; for Smart Printer; 1700 pieces on roll; stretchable 5 - 5.2 mm; plain; snap-on type; white

**Item No.: 2009-145/000-002**

Mini-WSB Inline; for Smart Printer; 1700 pieces on roll; stretchable 5 - 5.2 mm; plain; snap-on type; yellow



**Item No.: 248-501/000-006**

Mini-WSB marking card; as card; not stretchable; plain; snap-on type; blue

**Item No.: 248-501/000-007**

Mini-WSB marking card; as card; not stretchable; plain; snap-on type; gray

**Item No.: 248-501/000-023**

Mini-WSB marking card; as card; not stretchable; plain; snap-on type; green

**Item No.: 248-501/000-017**

Mini-WSB marking card; as card; not stretchable; plain; snap-on type; light green



**Item No.: 248-501/000-012**

Mini-WSB marking card; as card; not stretchable; plain; snap-on type; orange

**Item No.: 248-501/000-005**

Mini-WSB marking card; as card; not stretchable; plain; snap-on type; red

**Item No.: 248-501**

Mini-WSB marking card; as card; not stretchable; plain; snap-on type; white

**Item No.: 248-501/000-002**

Mini-WSB marking card; as card; not stretchable; plain; snap-on type; yellow



**Item No.: 793-5501/000-006**

WMB marking card; as card; for terminal block width 5 - 17.5 mm; stretchable 5 - 5.2 mm; plain; snap-on type; blue

**Item No.: 793-5501/000-007**

WMB marking card; as card; for terminal block width 5 - 17.5 mm; stretchable 5 - 5.2 mm; plain; snap-on type; gray

**Item No.: 793-5501/000-023**

WMB marking card; as card; for terminal block width 5 - 17.5 mm; stretchable 5 - 5.2 mm; plain; snap-on type; green

**Item No.: 793-5501/000-017**

WMB marking card; as card; for terminal block width 5 - 17.5 mm; stretchable 5 - 5.2 mm; plain; snap-on type; light green



**Item No.: 793-5501/000-012**

WMB marking card; as card; for terminal block width 5 - 17.5 mm; stretchable 5 - 5.2 mm; plain; snap-on type; orange

**Item No.: 793-5501/000-005**

WMB marking card; as card; for terminal block width 5 - 17.5 mm; stretchable 5 - 5.2 mm; plain; snap-on type; red

**Item No.: 793-5501/000-024**

WMB marking card; as card; for terminal block width 5 - 17.5 mm; stretchable 5 - 5.2 mm; plain; snap-on type; violet

**Item No.: 793-5501**

WMB marking card; as card; for terminal block width 5 - 17.5 mm; stretchable 5 - 5.2 mm; plain; snap-on type; white



1.2.3.1 Marker



**Item No.: 793-5501/000-002**  
WMB marking card; as card; for terminal block width 5 - 17.5 mm; stretchable 5 - 5.2 mm; plain; snap-on type; yellow



**Item No.: 793-501/000-006**  
WMB marking card; as card; not stretchable; plain; snap-on type; blue



**Item No.: 793-501/000-007**  
WMB marking card; as card; not stretchable; plain; snap-on type; gray



**Item No.: 793-501/000-023**  
WMB marking card; as card; not stretchable; plain; snap-on type; green



**Item No.: 793-501/000-017**  
WMB marking card; as card; not stretchable; plain; snap-on type; light green



**Item No.: 793-501/000-012**  
WMB marking card; as card; not stretchable; plain; snap-on type; orange



**Item No.: 793-501/000-005**  
WMB marking card; as card; not stretchable; plain; snap-on type; red



**Item No.: 793-501/000-024**  
WMB marking card; as card; not stretchable; plain; snap-on type; violet



**Item No.: 793-501**  
WMB marking card; as card; not stretchable; plain; snap-on type; white



**Item No.: 793-501/000-002**  
WMB marking card; as card; not stretchable; plain; snap-on type; yellow



**Item No.: 2009-115/000-006**  
WMB-Inline; for Smart Printer; 1500 pieces on roll; stretchable 5 - 5.2 mm; plain; snap-on type; blue



**Item No.: 2009-115/000-007**  
WMB-Inline; for Smart Printer; 1500 pieces on roll; stretchable 5 - 5.2 mm; plain; snap-on type; gray



**Item No.: 2009-115/000-023**  
WMB-Inline; for Smart Printer; 1500 pieces on roll; stretchable 5 - 5.2 mm; plain; snap-on type; green



**Item No.: 2009-115/000-017**  
WMB-Inline; for Smart Printer; 1500 pieces on roll; stretchable 5 - 5.2 mm; plain; snap-on type; light green



**Item No.: 2009-115/000-012**  
WMB-Inline; for Smart Printer; 1500 pieces on roll; stretchable 5 - 5.2 mm; plain; snap-on type; orange



**Item No.: 2009-115/000-024**  
WMB-Inline; for Smart Printer; 1500 pieces on roll; stretchable 5 - 5.2 mm; plain; snap-on type; violet



**Item No.: 2009-115**  
WMB-Inline; for Smart Printer; 1500 pieces on roll; stretchable 5 - 5.2 mm; plain; snap-on type; white



**Item No.: 2009-115/000-002**  
WMB-Inline; for Smart Printer; 1500 pieces on roll; stretchable 5 - 5.2 mm; plain; snap-on type; yellow

1.2.3.2 Marking strip



**Item No.: 2009-110/762-852**  
Marking strips; for Smart Printer; cut to a defined length; MARKED; not stretchable; snap-on type; white



**Item No.: 2009-110/762-853**  
Marking strips; for Smart Printer; cut to a defined length; MARKED; not stretchable; snap-on type; white



**Item No.: 2009-110/762-854**  
Marking strips; for Smart Printer; cut to a defined length; MARKED; not stretchable; snap-on type; white



**Item No.: 2009-110/762-855**  
Marking strips; for Smart Printer; cut to a defined length; MARKED; not stretchable; snap-on type; white



**Item No.: 2009-110/762-856**  
Marking strips; for Smart Printer; cut to a defined length; MARKED; not stretchable; snap-on type; white



**Item No.: 2009-110/762-857**  
Marking strips; for Smart Printer; cut to a defined length; MARKED; not stretchable; snap-on type; white



**Item No.: 2009-110/762-858**  
Marking strips; for Smart Printer; cut to a defined length; MARKED; not stretchable; snap-on type; white



**Item No.: 2009-110/762-859**  
Marking strips; for Smart Printer; cut to a defined length; MARKED; not stretchable; snap-on type; white



**Item No.: 2009-110**  
Marking strips; for Smart Printer; on reel; not stretchable; plain; snap-on type; white

1.2.4 Mounting adapter

1.2.4.1 Mounting accessories



**Item No.: 831-137**  
Mounting adapter; for DIN-35 rail/panel mounting; 3 parts; Pin spacing 7.62 mm; light gray

## 1.2.5 Strain relief

### 1.2.5.1 Strain relief plate



**Item No.: 831-505**

Strain relief plate; for female and male connectors; 30 mm wide; 1 part; Pin spacing 7.62 mm; light gray

## 1.2.6 Test and measurement

### 1.2.6.1 Testing accessories



**Item No.: 210-136**

Test plug; 2 mm Ø; with 500 mm cable; red

## 1.2.7 Tool

### 1.2.7.1 Operating tool



**Item No.: 210-721**

Operating tool; Blade: 5.5 x 0.8 mm; with a partially insulated shaft; multicoloured

## Installation Notes

### Conductor termination

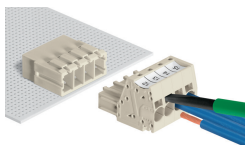

Inserting fine-stranded conductors via (5.5 x 0.8) mm screwdriver.

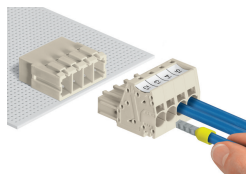

Solid and ferruled conductors are terminated by simply pushing them into unit.

## Testing

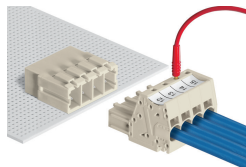

Testing with 2 mm Ø test plug.

Coding

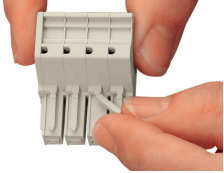

Break or cut off coding pin from female connector.

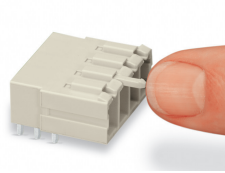

Insert coding pin into male header (break first) until it engages.

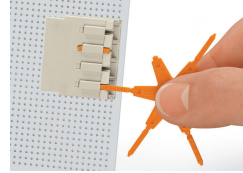

Coding a THT male header by inserting a coding pin.

Marking



Direct marking of female and male connectors



MCS MAXI male and female connectors can also be marked via Mini-WSB or WMB markers.