

E010 Series

Sealed Momentary Pushbutton Switches

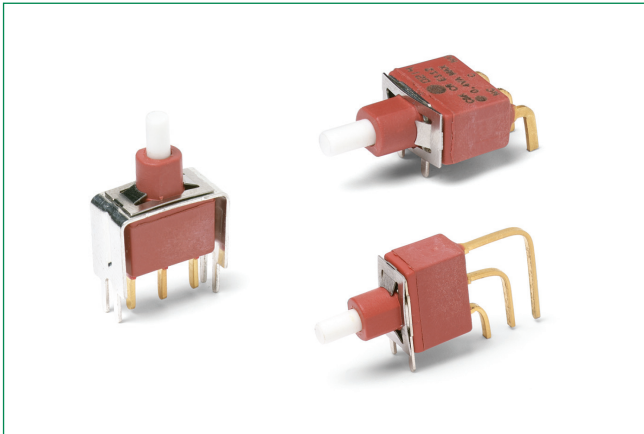

Agency Approvals

Agency	Agency File Number
US	E42363

Specifications

Contact Rating	Q contact material: 4 amps @ 125 V AC or 28 V DC. See page 6 for additional ratings.
Electrical Life	40,000 make-and-break cycles at full load.
Contact Resistance	Below 20 mΩ typ. initial @ 2–4 V DC, 100 mA, for both silver and gold plated contacts.
Insulation Resistance	10 ⁹ Ω min.
Dielectric Strength	1000 Vrms min. @ sea level
Operating Temperature	-30°C to 75°C.
Cap Installation Force	10 lbs. max. permissible.
Solderability	Per MIL-STD-202F method 208D, or EIA RS-186E method 9 (1 hour steam aging).

Notes:

Any models supplied with P, Q, B or G contact material are RoHS compliant. Specifications and materials listed above are for switches with standard options. For information on specific and custom switches, consult Customer Service Center. 6,000 cycles per UL Recognition Maximum 65 deg. cel. for UL Recognition

Description

The E010 series of sealed momentary pushbutton switches feature a long-life contact design and come with an optional snap-fitting plunger. Typically found in the telecommunications and networking industry, E010 switches accept a variety of caps, are RoHS compliant – and are process sealed to withstand soldering and cleaning.

Features & Benefits

- Process sealed, withstands soldering and cleaning
- Long life contact design
- Snap-fitting plunger available, accepts a variety of caps
- RoHS compliant models available

Applications

- Instrumentation
- Telecommunications and networking equipment
- Computers and peripherals

Materials

Case & Bushing	Glass filled nylon 6/6, flame retardant (UL94V-0)
Plunger	Glass filled nylon or glass filled polyester (PBT) (UL 94V-0), with internal o-ring seal standard.
Switch Support	Brass or steel, matte-tin plated.
Switch Support Retainer	Stainless steel
End Contacts	Q contact material: Coin silver, silver plated. See 6 for additional ratings.
Center Contacts & All Terminals	Q contact material: Copper alloy, silver plated. See page 6 for additional ratings.
Terminal Seal	Epoxy
Hardware	Nut & locking ring-Brass, nickel plated. Lockwasher-Steel, nickel plated.

E010 Series

Sealed Momentary Pushbutton Switches



Ordering Number

To order, simply select desired option from each category and place in the appropriate box. For additional options not shown in catalog, consult our Customer Service Center. All models are process sealed to withstand machine soldering temperatures and pressure wash cleaning methods.

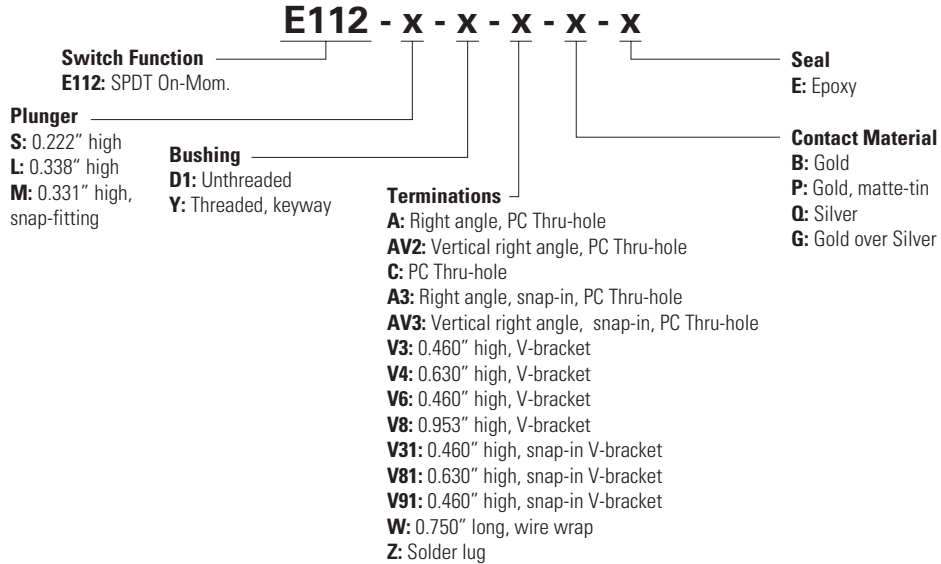

Switch Function

SPDT

No. Poles	No. Poles	Switch Function		Connected Terminals		Schematic
		POS. 1	POS. 2	POS. 1	POS. 2	
SP	E112	ON	MOM.	2-1	2-3	

Dimensions inches (mm)

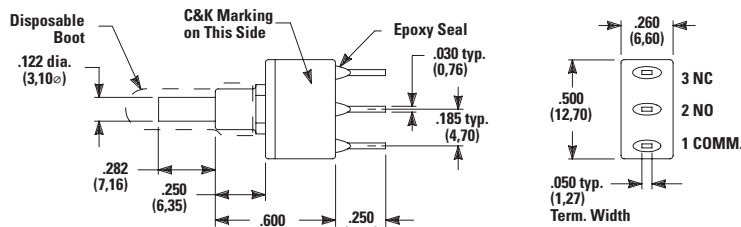

Part Number Shown: E112SD1CQE

MOM. = Momentary

All models C&K us with all options when ordered with G or Q contact material.

Terminal Nos. For Reference Only

E010 Series

Sealed Momentary Pushbutton Switches



Plunger Dimensions inches (mm)

S 0.218" High

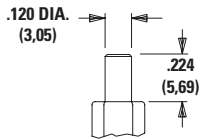

Standard with D1 bushing (as shown).
 † Subtract .100 (2,54) from plunger length when ordered with Y bushing.

L 0.338" High

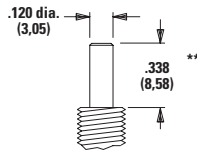

Standard with Y bushing (as shown).
 ** Add 0.100 (2.54) from plunger length when ordered with D1 bushing.

Notes: Caps available for all plunger options.

M 0.331" High, Snap-Fitting

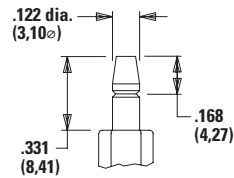

Bushing Dimensions inches (mm)

D1 Unthreaded

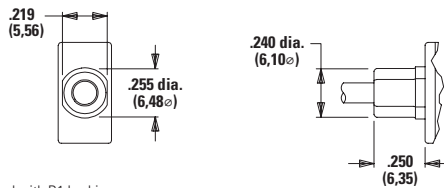

S plunger standard with D1 bushing.

Y Threaded, Keyway

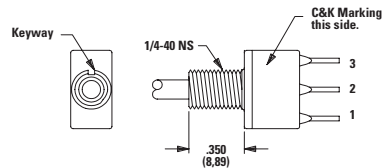

Notes:
 Internal o-ring actuator seal standard for all bushing options.

Panel Mounting

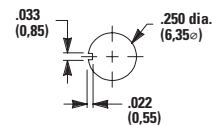

L plunger standard with Y bushing. Available only with C, Z terminations. Hardware: One dress nut part number 299D01201, one hex nut and lockwasher supplied standard. Withstands 4 in./lbs. without distortion.

Terminations Dimensions inches (mm)

C PCThru-hole SPDT

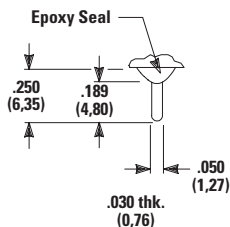

PC Mounting

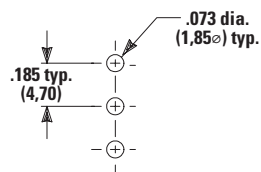

Z Solder Lug SPDT

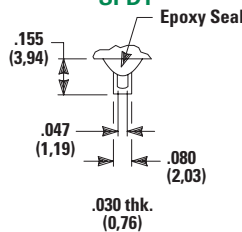

Notes:
 Not available with P contact materials

W Wire Wrap SPDT

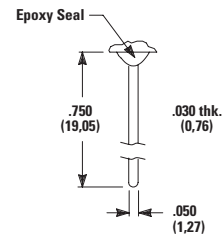

E010 Series

Sealed Momentary Pushbutton Switches



A Right Angle, PC Thru-hole E112SD1ABE SPDT

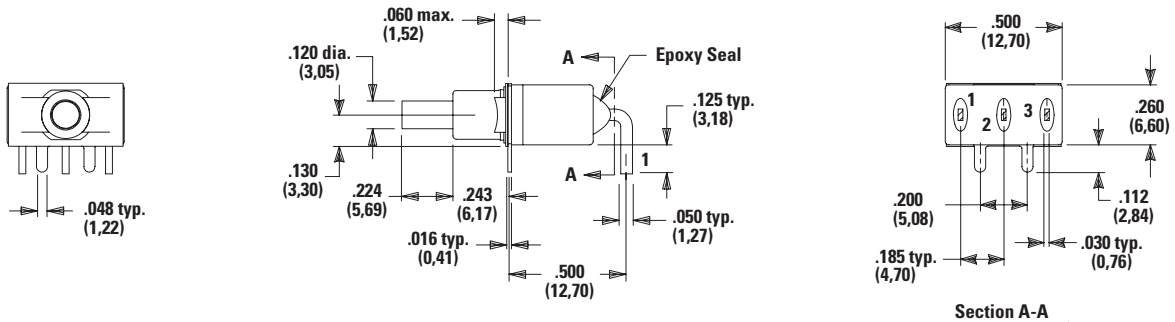

A3 Right Angle, Snap-in, PC Thru-hole Dimensions inches (mm)

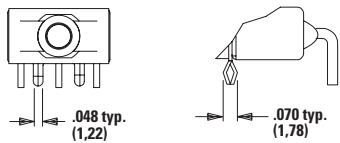

AW Right Angle, Extended, PC Thru-hole Dimensions inches (mm)

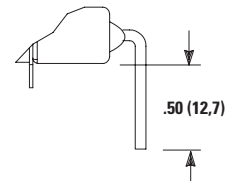

Notes:
Terminal bend radii and lead-in manufacturing option. Available with D1 bushing only.

PC Mounting Dimensions inches (mm)

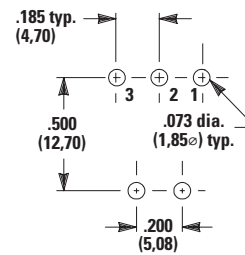

AV2 Vertical Right Angle, PC Thru-hole, 0.150" Pitch E112SD1AV2BE SPDT Dimensions inches (mm)

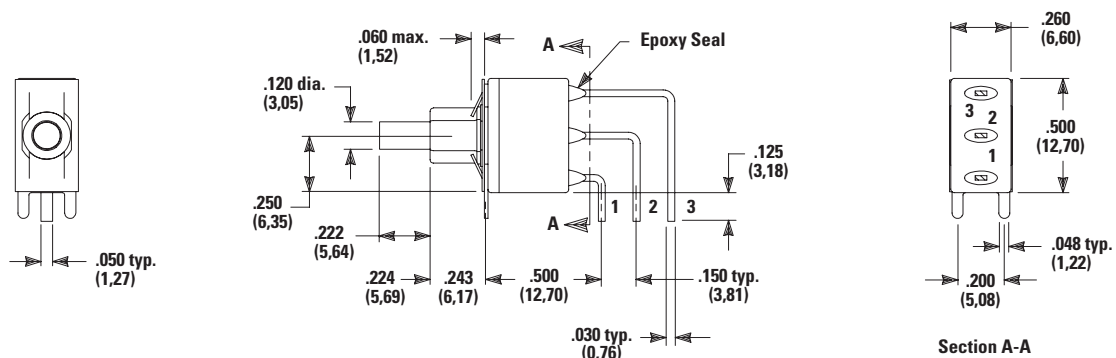

E010 Series

Sealed Momentary Pushbutton Switches



AV3 Vertical Right Angle, PC Thru-hole, 0.150" Pitch Dimensions inches (mm)

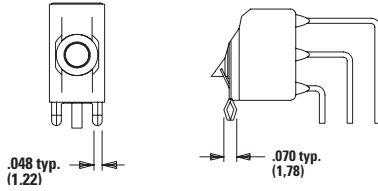

PC Mounting Dimensions inches (mm)

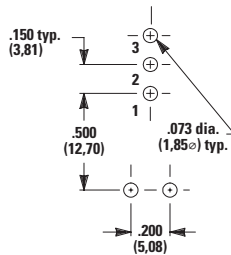

Notes:
Terminal bend radii and lead-in manufacturing option. Available with D1 bushing only.

V3, V4 Vertical Mount, V-Bracket V31, V91 Vertical Mount, V-Bracket, Snap-in E112SD1_BE SPDT Dimensions inches (mm)

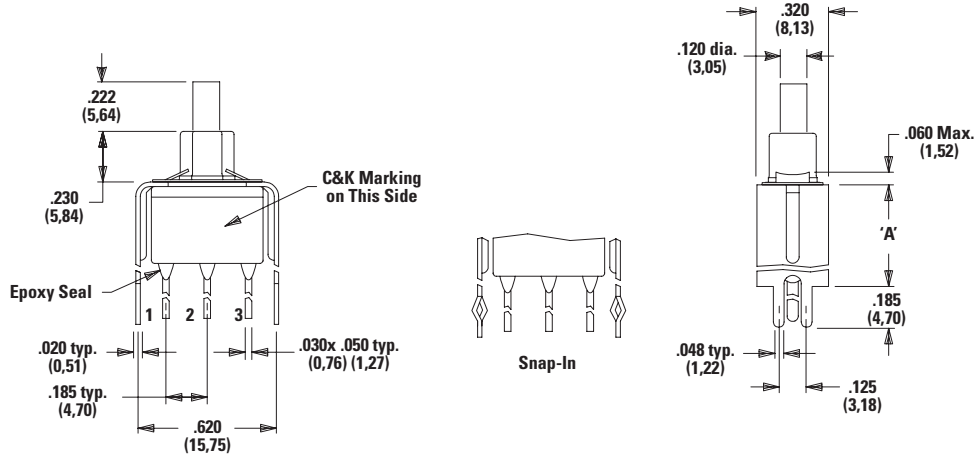

Notes:
Available with D1 bushing only.

PC Mounting Dimensions inches (mm)

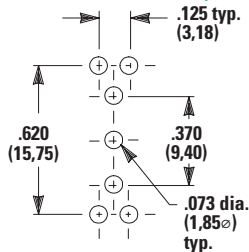

Option Code	DIM 'A'
V3, V31	0.460 (11.68)
V4	0.630 (16.00)
V91	1.150 (29.21)

E010 Series

Sealed Momentary Pushbutton Switches



V6, V8 Vertical Mount, V-Bracket V81 Vertical Mount, V-Bracket, Snap-in E112SD1_BE SPDT Dimensions inches (mm)

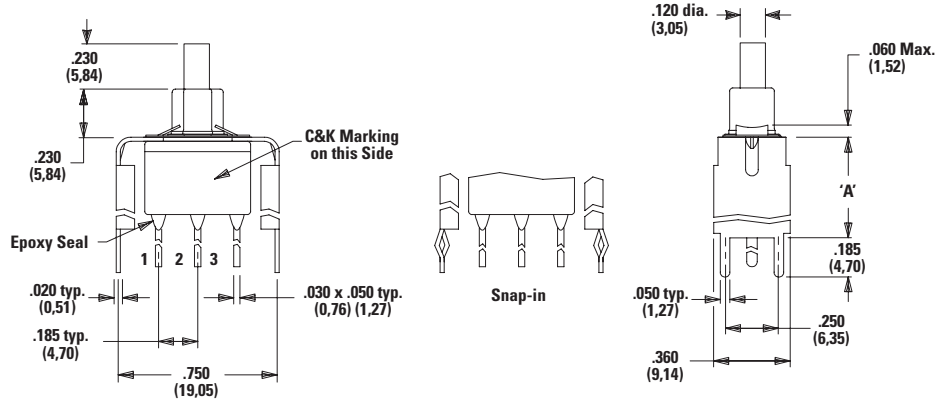

Notes:
Available with D1 bushing only.

PC Mounting Dimensions inches (mm)

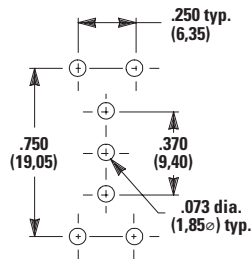

Option Code	DIM 'A'
V6	0.460 (11.68)
V8, V81	0.953 (24.21)

Contact Material

Option Code	Contact Material	Terminal Plating	Ratings	
B	Gold ¹	Gold ¹	Low Level/Dry Circuit	0.4 VA max. @ 20 V AC or DC max.
P		Matte-Tin ⁶		
Q	Silver ^{4,5}	Silver ⁵	Power	4 amps @ 125 V AC or 28 V DC
G	Gold over Silver ^{2,3}	Gold ³	Low Level/Dry Circuit or Power	0.4 VA max. @ 20 V AC or DC max. or 4 amps @ 125 V AC or 28 V DC

Notes:
See Technical Data section of this catalog for RoHS compliant and compatible definitions and specifications.
 1. Contacts & Terminals: Copper alloy, with gold plate over nickel plate.
 2. End Contacts: Coin silver, with gold plate over nickel plate.
 3. Center Contacts & All Terminals: Coin silver, with gold plate over nickel plate.
 4. End Contacts: Coin silver, silver plated.
 5. Center Contact & All Terminals: Copper alloy, silver plated.
 6. Terminals: Copper alloy, with matte tin over nickel plate.
 Any models supplied with P, Q, B or G contact material are RoHS compliant. All models c with all options when ordered with G or Q contact material.
 B contact material standard with all terminations except C, Z. Q contact material standard with C, Z terminations. P contact materials not available with Z terminations.

E010 Series

Sealed Momentary Pushbutton Switches



Seal E Epoxy Seal

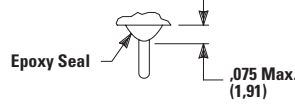

Available Hardware

Cap

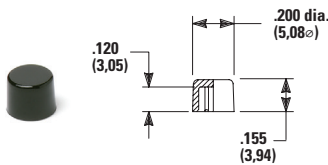

Part No.
708901000 White
708902000 Black
708903000 Red
Material: Nylon
Finish: Gloss

Cap

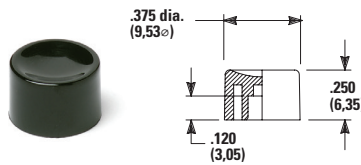

Part No.
752701000 White
752702000 Black
752703000 Red
Material: Nylon
Finish: Gloss

Cap

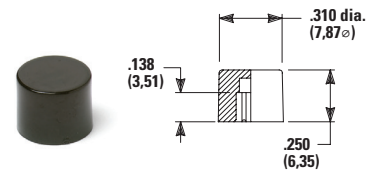

Part No.
801801000 White
801802000 Black
801803000 Red
Material: Nylon
Finish: Gloss

Cap, Snap Fitting Plunger

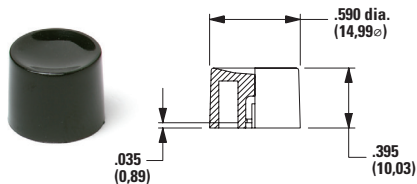

Part No.
452D01000 White
452D02000 Black
452D03000 Red
Material: Nylon
Finish: Gloss

Cap, Snap Fitting Plunger

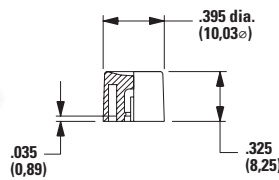

Part No.
894101000 White
894102000 Black
894103000 Red
Material: Nylon
Finish: Gloss

Cap

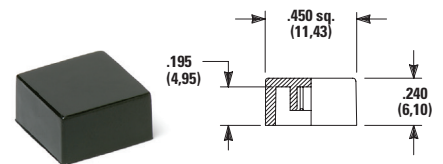

Part No.
484601000 White
484602000 Black
484603000 Red
Material: Nylon
Finish: Gloss

Part No.
798201000 White
798202263 Black
798203000 Red
Material: Nylon
Finish: Gloss

Note: Additional nuts, locking rings and lockwashers available separately, see section "Technical Data and Additional Hardware". Other cap colors available, consult Customer Service Center.

E010 Series

Sealed Momentary Pushbutton Switches



Frames snap into panel opening and are independent from switch mounting. Accurate positioning of the PC mounted switch relative to the panel opening is necessary to provide proper clearance between actuator and frame. Available in two basic styles and four panel thicknesses 0.047-0.125 in. Material: Nylon. Finish: Matte.

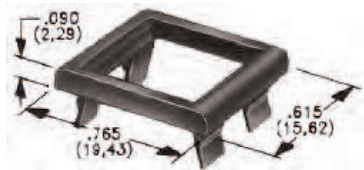

Typical Application

0.090" (2.29) Panel THK.
Part No. 432702263

0.125" (3.18) Panel THK.
Part No. 432802263 Black

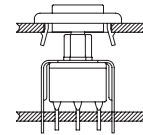

Panel Mounting

4325xxxxx, 4326xxxxx

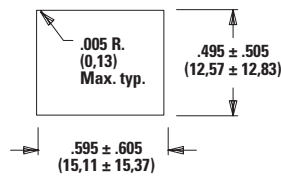

4327xxxxx, 4328xxxxx

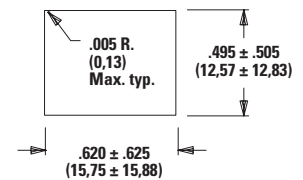

Panel Inserts

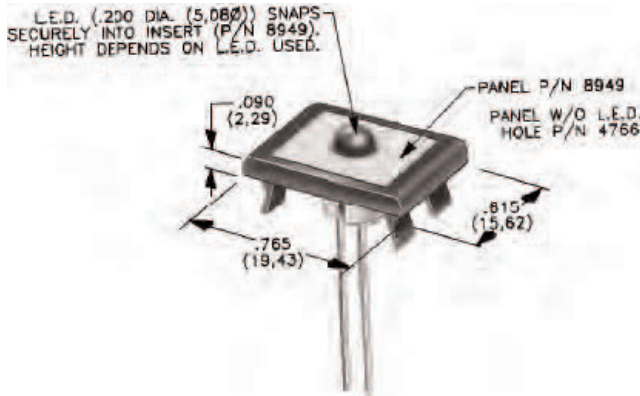

Above frames (part nos. 432XXXXXX) are also available with insert which accepts LED for indicator light assembly. Order insert separately from frame. Blank insert panel (without hole for LED) also available. LED not included.

Panel Insert with Hole for LED
Part No. 894902000

Blank Panel Insert without LED
Part No. 476602000 Black

Special colors, custom markings available, consult Customer Service Center.

Disclaimer Notice - Information furnished is believed to be accurate and reliable. However, users should independently evaluate the suitability of and test each product selected for their own applications. Littelfuse products are not designed for, and may not be used in, all applications. Read complete Disclaimer Notice at <http://www.littelfuse.com/disclaimer-electronics>.