

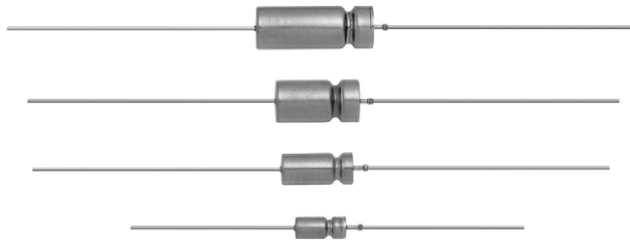

Wet Tantalum HI-TMP[®] Capacitors Tantalum Case With Glass-to-Tantalum Hermetic Seal for -55 °C to +200 °C Operation



FEATURES

- Models:
 - 134D - axial through-hole terminations
 - 134J - SMD, outward L-led terminations
 - 134L - SMD, inward L-led terminations
 - 134P - SMD, low profile outward L-led terminations
 - 134S - SMD, low profile inward L-led terminations
- High capacitance
- Hermetically sealed, tantalum case
- +200 °C high temperature
- Terminations: axial, standard tin / lead (SnPb)
- 100 % tin (RoHS-compliant) available
- Mounting: through-hole
- Material categorization: for definitions of compliance please see www.vishay.com/doc?99912



LINKS TO ADDITIONAL RESOURCES



PERFORMANCE CHARACTERISTICS

Operating Temperature: -55 °C to +85 °C (to +200 °C with voltage derating)

Capacitance Tolerance: at 120 Hz, +25 °C; ± 20 % standard; ± 10 %

DC Leakage Current (DCL Max.): at +25 °C and above: leakage current shall not exceed the values listed in the Standard Ratings tables.

Life Test: capacitors are capable of withstanding a minimum 500 h life test at a temperature of +200 °C at the applicable derated DC working voltage.

Note

* This datasheet provides information about parts that are RoHS-compliant and / or parts that are non RoHS-compliant. For example, parts with lead (Pb) terminations are not RoHS-compliant. Please see the information / tables in this datasheet for details

APPLICATIONS

- Industrial
- Petroleum exploration
- High temperature / high stress environment

ORDERING INFORMATION						
134D	227	X0	100	K	6	E3
TYPE	CAPACITANCE	CAPACITANCE TOLERANCE	DC VOLTAGE RATING AT +85 °C	CASE CODE	CASE INSULATION	RoHS-COMPLIANT
134D = axial through-hole leaded terminations 134J = SMD, outward L-led terminations 134L = SMD, inward L-led terminations 134P = low profile SMD, outward L-led terminations 134S = low profile SMD, inward L-led terminations	This is expressed in picofarads. The first two digits are the significant figures. The third is the number of zeros to follow	X0 = ± 20 % X9 = ± 10 %	This is expressed in volts. To complete the three-digit block, zeros precede the voltage rating. A decimal point is indicated by an "R" (6R3 = 6.3 V)	See Ratings and Case Codes table	8 = no outer case insulation 6 = high temperature insulation film	E3 = 100 % tin termination (RoHS-compliant design) Blank = SnPb termination (standard design)

Notes

- Packaging: the use of formed plastic trays for packaging these axial lead components is standard. Tape and reel is not available due to the unit weight
- Contact marketing for SMD capacitors availability
- Capacitors with SMD terminations are available only with high temperature (Kapton) film insulation



AXIAL PRODUCT DIMENSIONS in inches [millimeters]

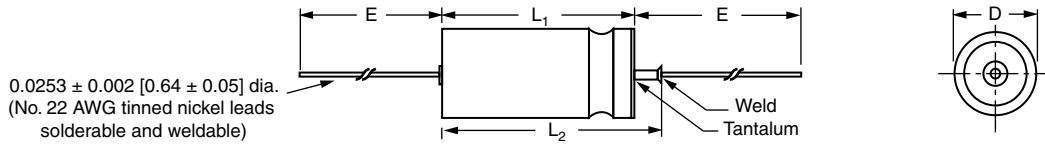

TYPE 134D	D	L ₁ ⁽¹⁾	L ₂ (Max.)	E	WEIGHT (g)
CASE CODE	± 0.016 [0.41]	+ 0.031 [0.79] - 0.016 [0.41]		± 0.250 [6.35]	(Max.)
C	0.188 [4.78]	0.453 [11.51]	0.734 [18.64]	1.500 [38.10]	2.6
F	0.281 [7.14]	0.641 [16.28]	0.922 [23.42]	2.250 [57.15]	6.2
T	0.375 [9.53]	0.766 [19.46]	1.047 [26.59]	2.250 [57.15]	11.6
K	0.375 [9.53]	1.062 [26.97]	1.343 [34.11]	2.250 [57.15]	17.7

Note

⁽¹⁾ For insulated parts, add 0.015 inches [0.38 mm] to the diameter. The insulation shall lap over the ends of the capacitor body

SMD PRODUCT DIMENSIONS in inches [millimeters]

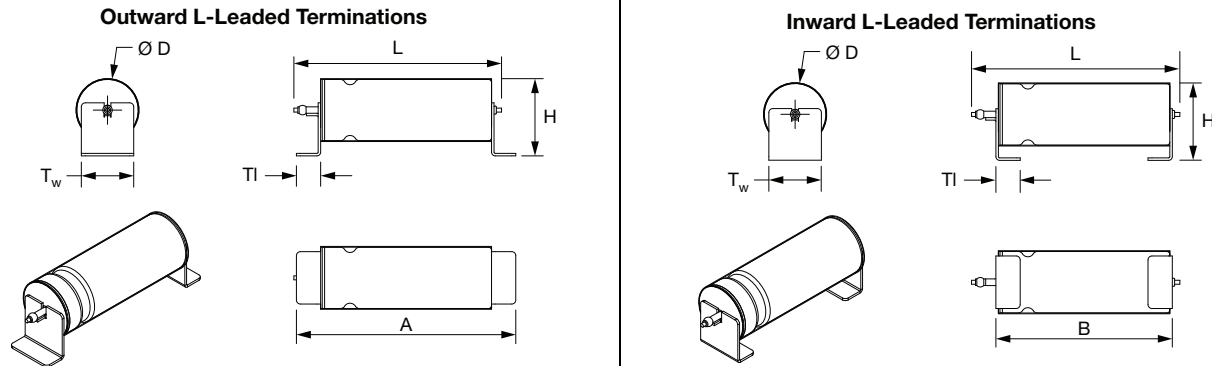

TYPE	134J / 134L / 134P / 134S				134J / 134P	134L / 134S	134J / 134L	134P / 134S
CASE CODE	D (max.)	L (max.)	TI (max.)	Tw ± 0.008	A (max.)	B (max.)	H (max.)	LP H (max.)
C	0.228 [5.8]	0.705 [17.9]	0.157 [4.0]	0.158 [4.0]	0.773 [19.6]	0.513 [13.0]	0.296 [7.5]	
F	0.300 [7.6]	0.903 [22.9]	0.157 [4.0]	0.217 [5.5]	1.001 [25.4]	0.720 [18.3]	0.374 [9.5]	
T	0.397 [10.1]	1.051 [26.7]	0.157 [4.0]	0.331 [8.4]	1.143 [29.0]	0.858 [21.8]	0.492 [12.5]	
K	0.397 [10.1]	1.343 [34.1]	0.157 [4.0]	0.331 [8.4]	1.432 [36.4]	1.140 [29.0]	0.492 [12.5]	0.421 [10.7]

Note

- Use appropriate adhesive between capacitor body and the board for improved mechanical strength



PAD DIMENSIONS in inches [millimeters]

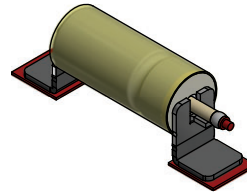
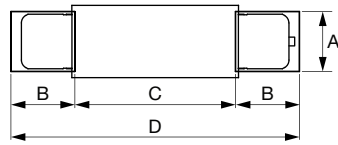

STYLE J, P

CASE CODE	A (min.)	B (nom.)	C (nom.)	D (nom.)
C	0.173 [4.40]	0.185 [4.70]	0.465 [11.80]	0.835 [21.20]
F	0.232 [5.90]	0.185 [4.70]	0.650 [16.50]	1.020 [25.90]
T	0.346 [8.80]	0.185 [4.70]	0.783 [19.90]	1.154 [29.30]
K	0.346 [8.80]	0.185 [4.70]	1.059 [26.90]	1.429 [36.30]

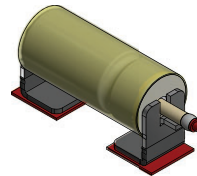
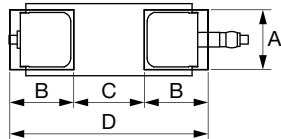

STYLE L, S

CASE CODE	A (min.)	B (nom.)	C (nom.)	D (nom.)
C	0.173 [4.40]	0.185 [4.70]	0.205 [5.20]	0.575 [14.60]
F	0.232 [5.90]	0.185 [4.70]	0.390 [9.90]	0.760 [19.30]
T	0.346 [8.80]	0.185 [4.70]	0.527 [13.39]	0.897 [22.79]
K	0.346 [8.80]	0.185 [4.70]	0.800 [20.32]	1.170 [29.72]

RATINGS AND CASE CODES (ESR mΩ)

μF	50 V	60 V	75 V	100 V	125 V
10					C
15				C	
33			C		
47		C			F
50					F
68	C			F	
100					T
110			F		
150		F		T	K
180			F		
220	F			K / T	
240					K
330			T		
350					K
390		T			
400				K	
470	T		K	K	
560		K		K	
680	K				
750			K	K	
1000		K	K		



STANDARD RATINGS												
CAPACITANCE AT 25 °C 120 Hz (μF)	CASE CODE	MAX. 120 Hz ESR (Ω)	MAX. DCL (μA)			MAX. IMP., Z AT -25 °C (Ω)	MAX. ΔCAP. AT -25 °C (%)	TYP. ΔCAP. (%)		AC RIPPLE 85 °C 40 kHz (mA) RMS	PART NUMBER	LIFE TEST PERFORMANCE (h AT +200 °C)
			25 °C	85 °C / 125 °C	200 °C			85 °C	125 °C			
50 V_{DC} AT 85 °C; 30 V_{DC} AT 125 °C; 30 V_{DC} AT 200 °C												
68	C	1.50	1	5	50	22	-6	12	55	1400	134(1)686(2)050C(3)(4)	500
220	F	0.90	2	10	100	9	-15	13	50	2300	134(1)227(2)050F(3)(4)	500
470	T	0.75	3	25	250	6	-24	10	25	2650	134(1)477(2)050T(3)(4)	500
680	K	0.70	5	40	400	4	-22	12	40	2900	134(1)687(2)050K(3)(4)	500
60 V_{DC} AT 85 °C; 40 V_{DC} AT 125 °C; 36 V_{DC} AT 200 °C												
47	C	2.00	1	5	50	34	-8	8	12	1250	134(1)476(2)060C(3)(4)	500
150	F	1.10	2	10	100	13	-11	10	30	2050	134(1)157(2)060F(3)(4)	500
390	T	0.90	3	25	250	7	-27	10	25	2450	134(1)397(2)060T(3)(4)	500
560	K	0.80	5	40	400	5	-21	12	40	2700	134(1)567(2)060K(3)(4)	500
1000	K	0.50	20	120	1200	3	-25	< 12	< 15	3500	134(1)108(2)060K(3)(4)	500
75 V_{DC} AT 85 °C; 50 V_{DC} AT 125 °C; 45 V_{DC} AT 200 °C												
33	C	2.50	1	5	50	45	-3.5	8	25	1100	134(1)336(2)075C(3)(4)	500
110	F	1.30	2	10	100	16	-8	8	30	1900	134(1)117(2)075F(3)(4)	500
180	F	1.50	5	25				15	20	2000	134(1)187(2)075F(3)(4)	500
330	T	1.00	3	30	300	8	-30	10	25	2300	134(1)337(2)075T(3)(4)	500
470	K	0.90	5	50	500	6	-20	10	40	2550	134(1)477(2)075K(3)(4)	500
750	K	0.60	20	120		3	-25	< 10	< 15	3500	134(1)757(2)075K(3)(4)	500
1000	K	0.50	25	90		3	-30	< 20	< 25	3500	134(1)108(2)075K(3)(4)	500
100 V_{DC} AT 85 °C; 65 V_{DC} AT 125 °C; 60 V_{DC} AT 200 °C												
15	C	3.50	1	5	50	95	-2.5	8	25	950	134(1)156(2)100C(3)(4)	500
68	F	2.10	2	10	100	25	-6	8	25	1500	134(1)686(2)100F(3)(4)	500
150	T	1.60	3	25	250	14	-12	8	22	1800	134(1)157(2)100T(3)(4)	500
220	T	1.60	5	30	300	15	-40	10	15	1800	134(1)227(2)100T(3)(4)	500
220	K	1.20	5	50	500	13	-44	8	15	2200	134(1)227(2)100K(3)(4)	1000
400	K	0.70	10	120	1200	5	-15	10	15	3250	134(1)407(2)100K(3)(4)	500
470	K	0.70	25	200	2000	8	-15	5	10	3250	134(1)477(2)100K(3)(4)	1000
560	K	0.70	25	200	2000	5	-25	15	20	5500	134(1)567(2)100K(3)(4)	1000
750	K	0.90	30	150	1500	4	-30	20	25	4500	134(1)757(2)100K(3)(4)	500
125 V_{DC} AT 85 °C; 85 V_{DC} AT 125 °C; 75 V_{DC} AT 200 °C												
10	C	5.50	1	5	50	145	-2.5	8	20	750	134(1)106(2)125C(3)(4)	500
47	F	2.30	2	10	100	35	-5	7	20	1450	134(1)476(2)125F(3)(4)	500
50	F	2.30	3	10	100	35	-5	7	20	1450	134(1)506(2)125F(3)(4)	500
100	T	1.80	3	25	250	24	-20	8	20	1700	134(1)107(2)125T(3)(4)	500
150	K	1.60	5	50	500	13	-10	6	12	1900	134(1)157(2)125K(3)(4)	500
240	K	0.80	10	50	500	10	-10	6	12	2500	134(1)247(2)125K(3)(4)	500
350	K	0.80	25	250	2500	15	-55	8	12	3250	134(1)357(2)125K(3)(4)	1000 ⁽¹⁾

Notes

- Part number definitions:
 - (1) Model type:
 - 134D - axial through-hole terminations
 - 134J - SMD, outward L-leaded terminations
 - 134L - SMD, inward L-leaded terminations
 - 134P - SMD, low profile outward L-leaded terminations
 - 134S - SMD, low profile inward L-leaded terminations
 - (2) Capacitance tolerance: X9 = 10 %, X0 = 20 %
 - (3) Style number: 8 = no film insulation, 6 = high temperature film insulation
 - (4) Termination: blank = standard tin/lead, E3 = RoHS-compliant 100 % tin
- ⁽¹⁾ This rating withstands 62 V_{DC} at 200 °C for 1000 h



RIPPLE CURRENT MULTIPLIERS VS. FREQUENCY, TEMPERATURE, AND APPLIED PEAK VOLTAGE																									
FREQUENCY OF APPLIED RIPPLE CURRENT		120 Hz				800 Hz				1 kHz				10 kHz				40 kHz				100 kHz			
AMBIENT STILL AIR TEMP. IN °C		≤ 55	85	105	125	≤ 55	85	105	125	≤ 55	85	105	125	≤ 55	85	105	125	≤ 55	85	105	125	≤ 55	85	105	125
% of rated peak voltage	100 %	0.60	0.39	-	-	0.71	0.43	-	-	0.72	0.46	-	-	0.88	0.55	-	-	1.0	0.63	-	-	1.1	0.69	-	-
	90 %	0.60	0.46	-	-	0.71	0.55	-	-	0.72	0.55	-	-	0.88	0.67	-	-	1.0	0.77	-	-	1.1	0.85	-	-
	80 %	0.60	0.52	0.35	-	0.71	0.62	0.42	-	0.72	0.62	0.42	-	0.88	0.76	0.52	-	1.0	0.87	0.59	-	1.1	0.96	0.65	-
	70 %	0.60	0.58	0.44	-	0.71	0.69	0.52	-	0.72	0.70	0.52	-	0.88	0.85	0.64	-	1.0	0.97	0.73	-	1.1	1.07	0.80	-
	66 2/3 %	0.60	0.60	0.46	0.27	0.71	0.71	0.55	0.32	0.72	0.72	0.55	0.32	0.88	0.88	0.68	0.40	1.0	1.0	0.77	0.45	1.1	1.1	0.85	0.50

TYPICAL PERFORMANCE CHARACTERISTICS OF 134D, 134J, 134L, 134P, 134S CAPACITORS

ELECTRICAL CHARACTERISTICS	
ITEM	PERFORMANCE CHARACTERISTICS
Operating temperature range	-55 °C to +85 °C (to +200 °C with voltage derating)
Capacitor tolerance	± 20 %, ± 10 % at 120 Hz, at +25 °C
Capacitor change by temperature	Limit per Standard Ratings table
ESR	Limit per Standard Ratings table, at +25 °C, 120 Hz
Impedance	Limit per Standard Ratings table, at -55 °C, 120 Hz
DCL (leakage current)	Limit per Standard Ratings table
AC ripple current	Limit per Standard Ratings table, at +85 °C and 40 kHz
Reverse voltage	None
Surge voltage	Surge voltage shall be in accordance with MIL-PRF-39006 and Table 2 of DSCC93026. The DC rated surge voltage is the maximum voltage to which the capacitors can be subjected under any conditions including transients and peak ripple at the highest line voltage. The DC surge voltage is 115 % of rated DC voltage.

PERFORMANCE CHARACTERISTICS	
ITEM	PERFORMANCE CHARACTERISTICS
Life testing	Capacitors shall be capable of withstanding a minimum 500 h life test at a temperature +200 °C at derated voltage.

ENVIRONMENTAL CHARACTERISTICS		
ITEM	CONDITION	COMMENTS
Seal	MIL-PRF-39006	When the capacitors are tested as specified in MIL-PRF-39006, there shall be no evidence of leakage.
Moisture resistance	MIL-PRF-39006	Moisture resistance shall be in accordance with MIL-PRF-39006. Number of cycles: 10 continuous cycles
Barometric pressure (reduced)	MIL-STD-202, method 105, condition E	Altitude 150 000 feet



MECHANICAL CHARACTERISTICS		
ITEM	TEST METHOD	CONDITION
Shock (specified pulse)	MIL-STD-202, method 213	Test condition I (100 g)
Vibration, high frequency	MIL-STD-202, method 204	Test condition D (20 g peak)
Thermal shock	MIL-STD-202, method 107	Test condition A, 30 cycles
Solderability	MIL-STD-202, method 208	ANSI/J-STD-002, test A Solderability shall be in accordance with MIL-PRF-39006.
Terminal strength	MIL-STD-202, method 211	Terminal strength shall be in accordance with MIL-PRF-39006.
Resistance to solder heat	MIL-STD-202, method 210	Test condition C The capacitors shall meet the requirements of MIL-PRF-39006.
Terminals	MIL-STD-1276	Terminals shall be as specified in MIL-STD-1276. The length and diameter of the terminals shall be as specified in Dimensions table. All terminals shall be permanently secured internally and externally, as applicable. All external joints shall be welded.
Marking	MIL-STD-1285	Marking of capacitors conforms to method I of MIL-STD-1285 and include capacitance (in μ F), capacitance tolerance letter, rated voltage, date code, lot symbol, and Vishay trademark.

SELECTOR GUIDES	
Tantalum Selector Guide	www.vishay.com/doc?49054
Parameter Comparison Guide	www.vishay.com/doc?42088



Disclaimer

ALL PRODUCT, PRODUCT SPECIFICATIONS AND DATA ARE SUBJECT TO CHANGE WITHOUT NOTICE TO IMPROVE RELIABILITY, FUNCTION OR DESIGN OR OTHERWISE.

Vishay Intertechnology, Inc., its affiliates, agents, and employees, and all persons acting on its or their behalf (collectively, "Vishay"), disclaim any and all liability for any errors, inaccuracies or incompleteness contained in any datasheet or in any other disclosure relating to any product.

Vishay makes no warranty, representation or guarantee regarding the suitability of the products for any particular purpose or the continuing production of any product. To the maximum extent permitted by applicable law, Vishay disclaims (i) any and all liability arising out of the application or use of any product, (ii) any and all liability, including without limitation special, consequential or incidental damages, and (iii) any and all implied warranties, including warranties of fitness for particular purpose, non-infringement and merchantability.

Statements regarding the suitability of products for certain types of applications are based on Vishay's knowledge of typical requirements that are often placed on Vishay products in generic applications. Such statements are not binding statements about the suitability of products for a particular application. It is the customer's responsibility to validate that a particular product with the properties described in the product specification is suitable for use in a particular application. Parameters provided in datasheets and / or specifications may vary in different applications and performance may vary over time. All operating parameters, including typical parameters, must be validated for each customer application by the customer's technical experts. Product specifications do not expand or otherwise modify Vishay's terms and conditions of purchase, including but not limited to the warranty expressed therein.

Hyperlinks included in this datasheet may direct users to third-party websites. These links are provided as a convenience and for informational purposes only. Inclusion of these hyperlinks does not constitute an endorsement or an approval by Vishay of any of the products, services or opinions of the corporation, organization or individual associated with the third-party website. Vishay disclaims any and all liability and bears no responsibility for the accuracy, legality or content of the third-party website or for that of subsequent links.

Vishay products are not designed for use in life-saving or life-sustaining applications or any application in which the failure of the Vishay product could result in personal injury or death unless specifically qualified in writing by Vishay. Customers using or selling Vishay products not expressly indicated for use in such applications do so at their own risk. Please contact authorized Vishay personnel to obtain written terms and conditions regarding products designed for such applications.

No license, express or implied, by estoppel or otherwise, to any intellectual property rights is granted by this document or by any conduct of Vishay. Product names and markings noted herein may be trademarks of their respective owners.