

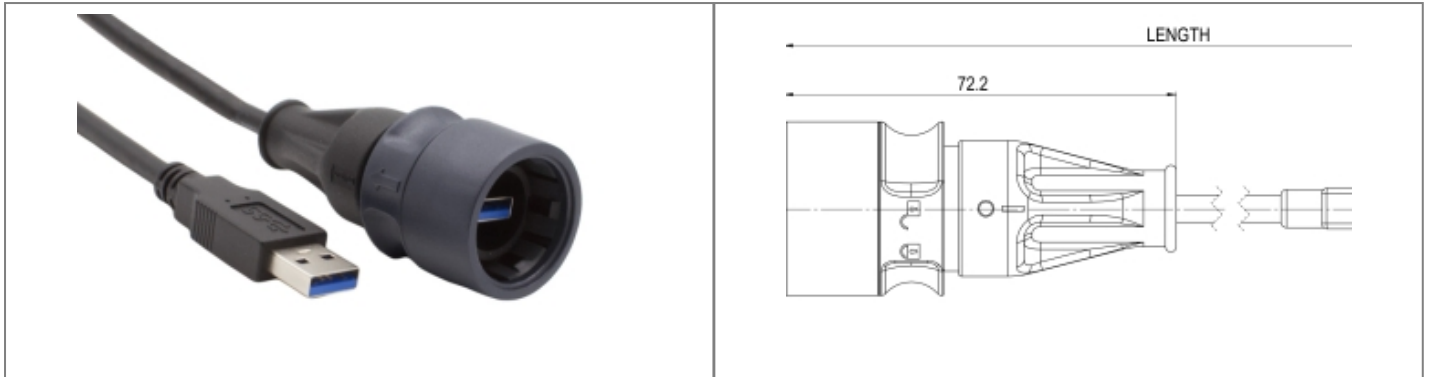







PXP6040/AA3/3M00 Datasheet

**Product Name // Plastic Body Overmoulded USB Cable
Standard 3.0 A Plug to Sealed 3.0 A Plug 3M Cable**

 [View Product Page](#)



// Product Description:

-  Pre-Wired Plastic Body Overmoulded USB 3.0 Cable
-  Water and dustproof to IP68 & IP69K when mated with compatible connector
-  30 degree push twist locking, tamperproof lock prevents accidental un-mating
-  Choice of USB A, B & C connections
-  Choice of cable lengths
-  PXP6081 Sealing Cap available separately to maintain IP rating of unmated connectors
-  Mate with 6000 Series Plastic Body USB Panel Mount Connectors

// General Information:

Product Display Title:	Plastic Body Overmoulded USB Cable Standard 3.0 A Plug to Sealed 3.0 A Plug 3M Cable
Product Family:	Circular Data Connectors
Product Series:	6000 Series - USB Buccaneer
Approvals:	CSA, UL, VDE
Body Material:	Polycarbonate/Polybutylene Terephthalate (PC/PBT)
Body Material Type:	Plastic Body
Cable Length:	3m
Contact Type:	Plug Contact
Coupling Type:	Push-Twist
Current Max:	1A
Data Cable Type:	Standard 3.0 A Plug to Sealed 3.0 A Plug
Diameter Over Coupling Ring Mm:	32mm
Flamability Rating:	UL94V-0
Function:	Flex to Standard Connector Double Ended Cable
Ip Rating:	IP66, IP68, IP69K
Max Operating Temperature:	+70°C
Min Operating Temperature:	0°C
Number Of Contacts:	8 Contacts
Voltage Max:	30V

// Product PDF Links

 [6000 Series HDMI Product Data](#)

// Product 3D CAD Model Links

 [PXP6040/AA3/3M003D CAD Model](#)