



Quality Products. Service Excellence.

105-550 CFM Filtered Fan Boxes *XF Series*



Description

- In a typical cooling arrangement, the filtered fan box pulls air into the enclosures and the filter grill is used as an air outlet.
- The washable aluminum filter grill and the air filter are easily accessible and can be removed for cleaning.
- The filtered fan boxes are available in either 115 VAC or 230 VAC, 50/60 Hz.
- Filtered passive ventilation can be provided by an exhaust filter for either convection cooling or in combination with a fan in forced air cooling.

Standards

- UR/CUR/CE approved fan motors.
- CSA listed on fan only.

Features

- 115 VAC or 230 VAC, 50/60 Hz.
- 12" lead wires.
- Exceptionally quiet operation.
- Versatile mounting and adaptability.
- Heavy-gauge steel construction.
- Attractive stainless steel grills.
- Shipped with air flow to pressurize. Can be user modified to exhaust.
- Aluminum filter is coated with adhesive baffle surfaces for dust and dirt collection. Can be recoated after cleaning for optimum performance.
- Drilling template included.
- **Note:** One grill and filter are included with each fan package. Normally, an additional exhaust grill and filter are required for each installation and must be ordered separately.

Accessories

- Filter Coat
- Thermostats

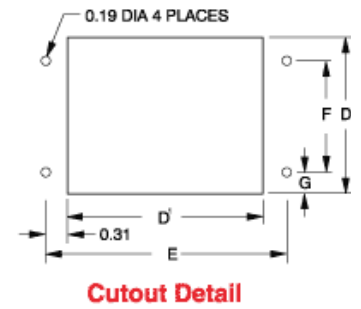
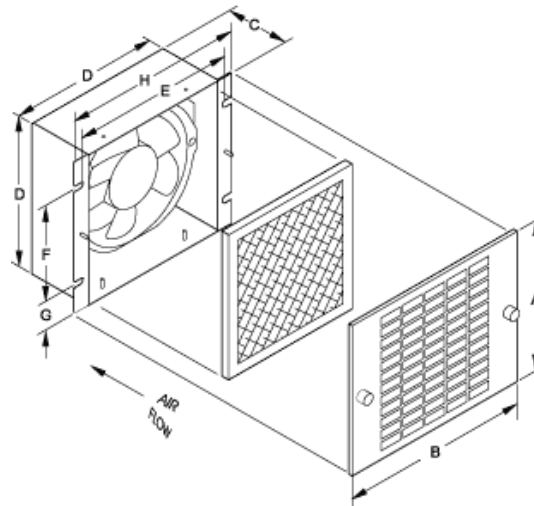

Filtered Fan Boxes

Part No.	Free Flow Air Delivery		RPM Nominal	Running		Fan Housing		
	(CFM)	Volts		Amps	Watts	H	W	D
XF4115	105	115	3000	0.18	15	5.63	5.63	2.38
XF4230	105	230	3000	0.09	15	5.63	5.63	2.38
XF6115	220	115	3300	0.29	33	7.13	7.13	3.00
XF6230	220	230	3300	0.15	33	7.13	7.13	3.00
XF10115	560	115	1600	0.87	60	11.13	11.13	4.56
XF10230	560	230	1600	0.45	60	11.13	11.13	4.56

¹ Dimension for mounting and cabinet cutout. Secure sheet metal with #10 hardware.

Exhaust Grill and Filters

Part No.	H	W
XFG4	6.13	7.38
XFG6	7.63	8.88
XFG10	11.63	13.00

¹ Dimension for mounting and cabinet cutout. Secure sheet metal with #10 hardware.

Replacement Filters

Part No.	Pkg. Qty.
XFF4	3
XFF6	3
XFF10	3

Tags: filter, fan box, exhaust, grille, grill, forced air, passive air, temperature

Data subject to change without notice

© 2026. Hammond Manufacturing Ltd. All rights reserved.