

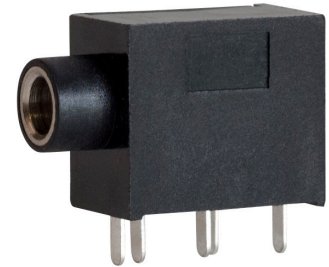

SERIES: SJ1-353XNG | DESCRIPTION: AUDIO JACK

FEATURES

- low profile design
- switch options include:
 - no switch
 - tip switch
 - tip and ring switch



PART NUMBER KEY

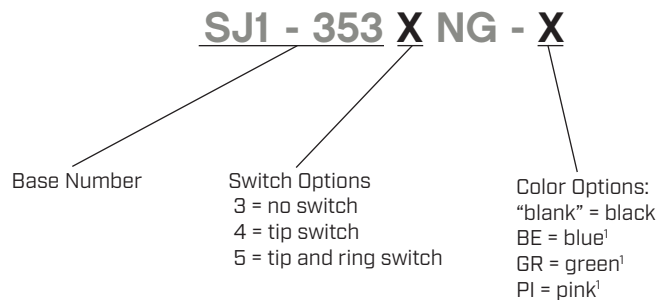

Note: ¹. Tip and ring switch option only.

SPECIFICATIONS

parameter	conditions/description	min	typ	max	units
rated input voltage			12		Vdc
rated input current				1	A
contact resistance				50	mΩ
insulation resistance	at 500 Vdc	100			MΩ
voltage withstand	for 1 minute			500	Vac
insertion/withdrawal force		0.3		3	kg
operating temperature		-25		85	°C
life			5,000		cycles
flammability rating	UL94V-0				
RoHS	yes				

SOLDERABILITY

parameter	conditions/description	min	typ	max	units
wave soldering	dipped in solder pot for 5±0.5 seconds	255	260	265	°C

MECHANICAL DRAWING

units: mm
 tolerance:
 X. ± 0.50 mm
 X.X ± 0.30 mm
 X.XX ± 0.20 mm
 PCB: ± 0.05 mm
 unless otherwise specified

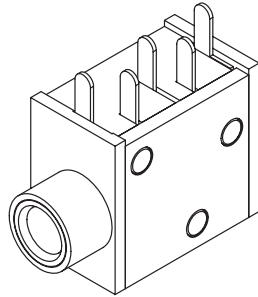

DESCRIPTION	MATERIAL	PLATING/COLOR
terminal 1	brass t=0.3 mm	silver
terminal 2	brass t=0.3 mm	silver
terminal 3	copper alloy	silver
terminal 4	brass t=0.3 mm	silver
terminal 5	brass t=0.3 mm	silver
bushing	brass	nickel
spring	carbon steel	
housing	PBT (UL94V-0)	see page 1 options
cover	PBT (UL94V-0)	see page 1 options

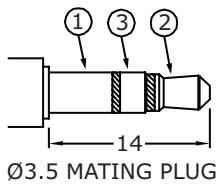
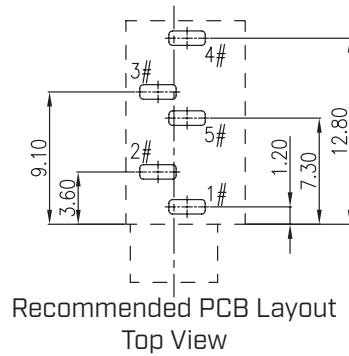
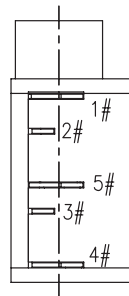
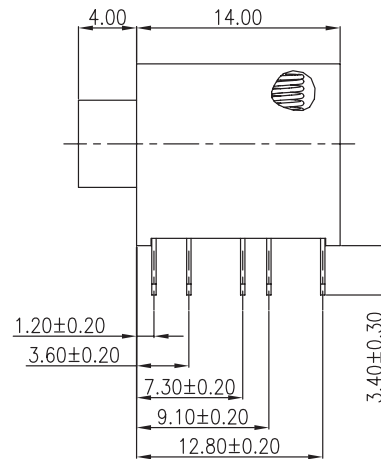
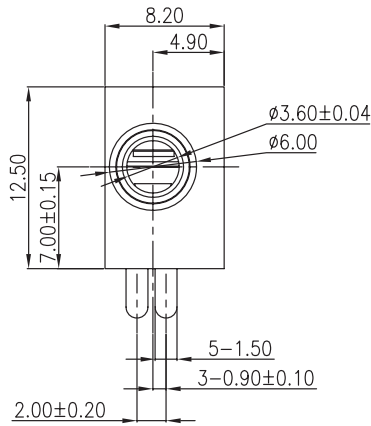

Model No.	SJ1-3533NG	SJ1-3534NG	SJ1-3535NG
Schematic			
PIN			
1	sleeve	sleeve	sleeve
2	tip	tip	tip
3	ring	ring	ring
4	NP	tip switch	tip switch
5	NP	NP	ring switch

REVISION HISTORY

rev.	description	date
1.0	initial release	06/04/2007
1.01	new template applied	01/25/2012
1.02	updated product picture	04/18/2013
1.03	brand update	10/10/2019
1.04	product reengineered for improved manufacturability and production yield, see PCN for details	08/10/2022
1.05	CUI Devices rebranded to Same Sky	09/12/2024
1.06	changed terminal plating to be silver	03/10/2025

The revision history provided is for informational purposes only and is believed to be accurate.



Same Sky offers a one (1) year limited warranty. Complete warranty information is listed on our website.

Same Sky reserves the right to make changes to the product at any time without notice. Information provided by Same Sky is believed to be accurate and reliable. However, no responsibility is assumed by Same Sky for its use, nor for any infringements of patents or other rights of third parties which may result from its use.

Same Sky products are not authorized or warranted for use as critical components in equipment that requires an extremely high level of reliability. A critical component is any component of a life support device or system whose failure to perform can be reasonably expected to cause the failure of the life support device or system, or to affect its safety or effectiveness.

[sameskydevices.com](https://www.sameskydevices.com)