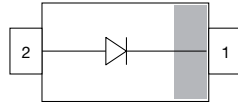
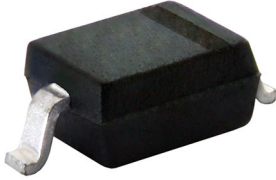


## Small Signal Fast Switching Diode



### FEATURES

- Silicon epitaxial planar diode
- Fast switching diodes ( $t_{rr} \leq 4\text{ns}$ )
- AEC-Q101 qualified available
- Molding compound meets UL 94 V-0 flammability rating
- Moisture sensitivity level (MSL) 1
- Base P/N-E3 - RoHS-compliant, commercial grade
- Base P/N-HE3\_A - RoHS-compliant, AEC-Q101 qualified
- Material categorization: for definitions of compliance please see [www.vishay.com/doc?99912](http://www.vishay.com/doc?99912)

 AUTOMOTIVE  
GRADE  
Available

**RoHS**  
COMPLIANT

### LINKS TO ADDITIONAL RESOURCES



### MECHANICAL DATA

**Case:** SOD-323

**Weight:** approx. 4 mg

**Packaging codes / options:**

18/10K per 13" reel (8 mm tape), 10K/box

08/3K per 7" reel (8 mm tape), 15K/box

PARTS TABLE						
PART	ORDERING CODE	AEC-Q101 QUALIFIED	TYPE MARKING	CIRCUIT CONFIGURATION	TAPED UNITS PER REEL	MINIMUM ORDER QUANTITY
1N4148WS	1N4148WS-E3-08	No	2A	Single	3000 (8 mm tape on 7" reel)	15 000
	1N4148WS-HE3_A-08	Yes				
	1N4148WS-E3-18	No			10 000 (8 mm tape on 13" reel)	10 000
	1N4148WS-HE3_A-18	Yes				

PACKAGE				
PACKAGE NAME	WEIGHT	MOLDING COMPOUND	MOISTURE SENSITIVITY	SOLDERING CONDITIONS
SOD-323	4 mg	UL 94 V-0	MSL 1 (according J-STD-020)	Peak temperature max. 260 °C

ABSOLUTE MAXIMUM RATINGS ( $T_{amb} = 25\text{ °C}$ , unless otherwise specified)				
PARAMETER	TEST CONDITION	SYMBOL	VALUE	UNIT
Reverse voltage		$V_R$	75	V
Repetitive peak reverse voltage		$V_{RRM}$	100	V
Average rectified current half wave rectification with resistive load <sup>(1)</sup>	$f \geq 50\text{ Hz}$	$I_{F(AV)}$	150	mA
Continuous forward current <sup>(1)</sup>		$I_F$	250	mA
Surge forward current <sup>(1)</sup>	$t_p < 1\text{ s}$	$I_{FSM}$	350	mA
	$t_p = 1\text{ }\mu\text{s}$	$I_{FSM}$	2	A
Power dissipation <sup>(1)</sup>		$P_{tot}$	200	mW

**Note**
<sup>(1)</sup> Infinite heatsink

THERMAL CHARACTERISTICS ( $T_{amb} = 25\text{ °C}$ , unless otherwise specified)				
PARAMETER	TEST CONDITION	SYMBOL	VALUE	UNIT
Thermal resistance junction to lead	Infinite heat sink	$R_{thJL}$	625	K/W
Junction temperature		$T_j$	150	°C
Storage temperature range		$T_{stg}$	-65 to +150	°C
Operating temperature range		$T_{op}$	-55 to +150	°C

<b>ELECTRICAL CHARACTERISTICS</b> ( $T_{amb} = 25\text{ }^{\circ}\text{C}$ , unless otherwise specified)				
PARAMETER	TEST CONDITION	SYMBOL	MAX.	UNIT
Forward voltage	$I_F = 10\text{ mA}$	$V_F$	1	V
	$I_F = 100\text{ mA}$	$V_F$	1.2	V
Leakage current	$V_R = 20\text{ V}$	$I_R$	25	nA
	$V_R = 75\text{ V}$	$I_R$	1	$\mu\text{A}$
	$V_R = 100\text{ V}$	$I_R$	100	$\mu\text{A}$
	$V_R = 20\text{ V}, T_J = 150\text{ }^{\circ}\text{C}$	$I_R$	50	$\mu\text{A}$
Diode capacitance	$V_F = V_R = 0\text{ V}$	$C_D$	1.5	pF
Voltage rise when switching ON	Tested with 50 mA pulses, $t_p = 0.1\text{ }\mu\text{s}$ , rise time < 30 ns, $f_p = (5\text{ to }100)\text{ kHz}$	$V_{fr}$	2.5	V
Reverse recovery time	$I_F = 10\text{ mA}, I_R = 1\text{ mA}, V_R = 6\text{ V}, R_L = 100\text{ }\Omega$	$t_{rr}$	4	ns

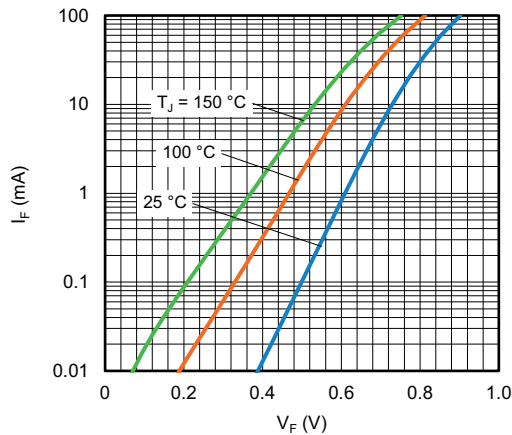
**TYPICAL CHARACTERISTICS** ( $T_{amb} = 25\text{ }^{\circ}\text{C}$ , unless otherwise specified)


Fig. 1 - Typical Forward Current vs. Forward Voltage

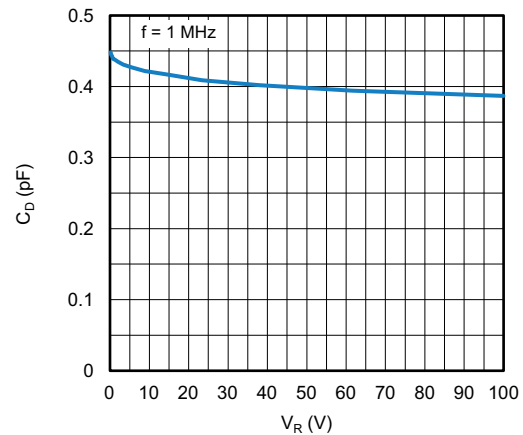


Fig. 3 - Typical Capacitance vs. Reverse Voltage

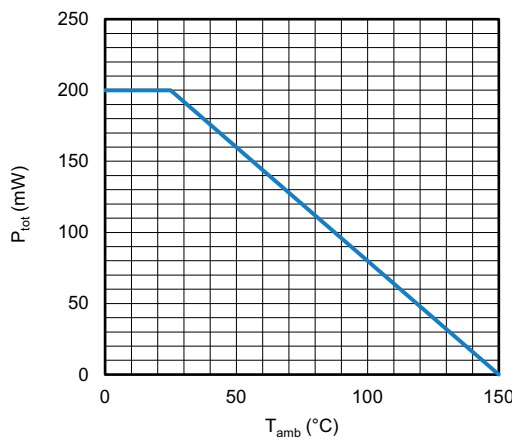


Fig. 2 - Admissible Power Dissipation vs. Ambient Temperature

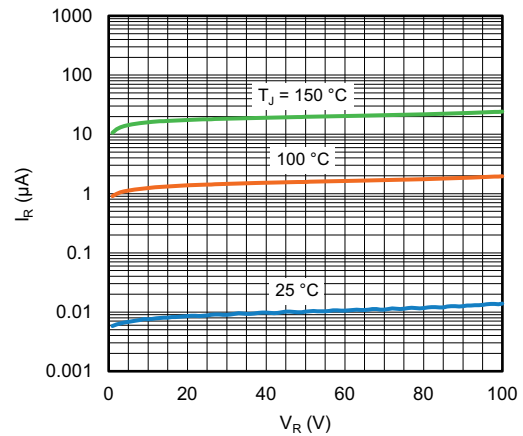
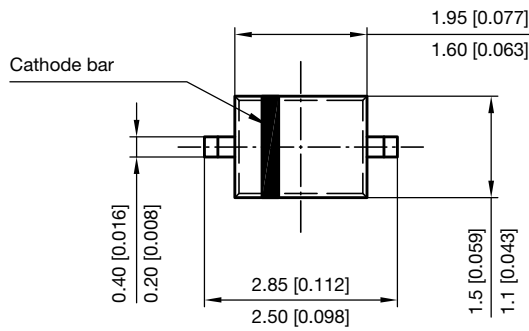
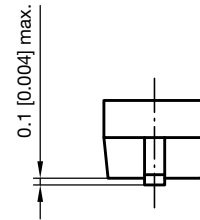
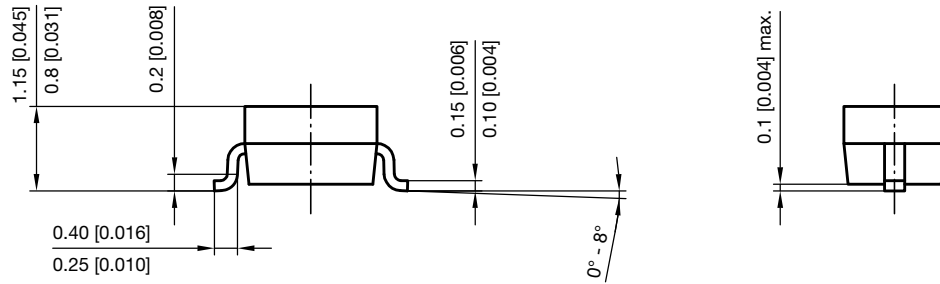


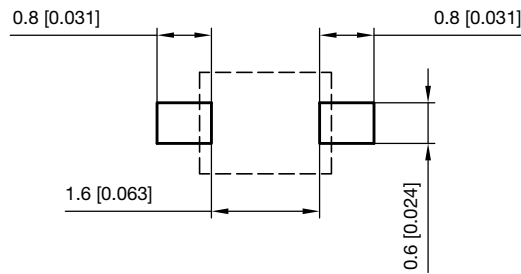
Fig. 4 - Typical Reverse Leakage Current vs. Reverse Voltage



PACKAGE DIMENSIONS in millimeters (inches) **SOD-323**



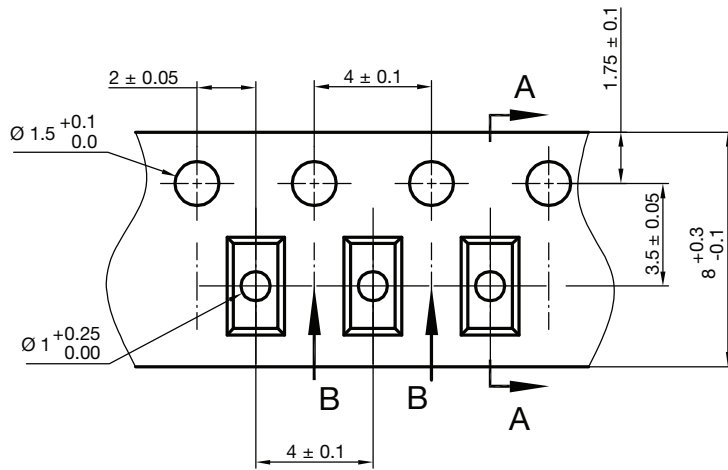
Footprint recommendation:



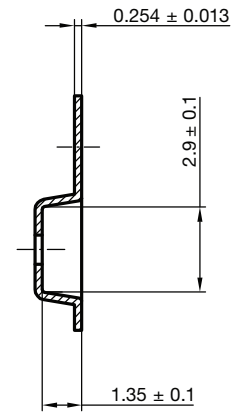
Document no.: S8-V-3910.02-001 (4)  
 Created - Date: 24.August.2004  
 Rev. 6 - Date: 23.Sept.2016  
 22771



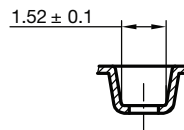
CARRIER TAPE SOD-323



A-A Section

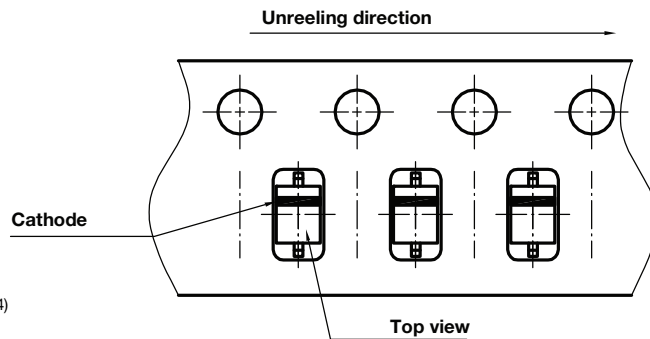


B-B Section



Document no.: S8-V-3717.07-002 (4)  
Created - Date: 09. Feb. 2010  
22824

ORIENTATION IN CARRIER TAPE SOD-323



Document no.: S8-V-3717.07-003 (4)  
Created - Date: 09. Feb. 2010  
22772



## **Disclaimer**

ALL PRODUCT, PRODUCT SPECIFICATIONS AND DATA ARE SUBJECT TO CHANGE WITHOUT NOTICE TO IMPROVE RELIABILITY, FUNCTION OR DESIGN OR OTHERWISE.

Vishay Intertechnology, Inc., its affiliates, agents, and employees, and all persons acting on its or their behalf (collectively, "Vishay"), disclaim any and all liability for any errors, inaccuracies or incompleteness contained in any datasheet or in any other disclosure relating to any product.

Vishay makes no warranty, representation or guarantee regarding the suitability of the products for any particular purpose or the continuing production of any product. To the maximum extent permitted by applicable law, Vishay disclaims (i) any and all liability arising out of the application or use of any product, (ii) any and all liability, including without limitation special, consequential or incidental damages, and (iii) any and all implied warranties, including warranties of fitness for particular purpose, non-infringement and merchantability.

Statements regarding the suitability of products for certain types of applications are based on Vishay's knowledge of typical requirements that are often placed on Vishay products in generic applications. Such statements are not binding statements about the suitability of products for a particular application. It is the customer's responsibility to validate that a particular product with the properties described in the product specification is suitable for use in a particular application. Parameters provided in datasheets and / or specifications may vary in different applications and performance may vary over time. All operating parameters, including typical parameters, must be validated for each customer application by the customer's technical experts. Product specifications do not expand or otherwise modify Vishay's terms and conditions of purchase, including but not limited to the warranty expressed therein.

Hyperlinks included in this datasheet may direct users to third-party websites. These links are provided as a convenience and for informational purposes only. Inclusion of these hyperlinks does not constitute an endorsement or an approval by Vishay of any of the products, services or opinions of the corporation, organization or individual associated with the third-party website. Vishay disclaims any and all liability and bears no responsibility for the accuracy, legality or content of the third-party website or for that of subsequent links.

Vishay products are not designed for use in life-saving or life-sustaining applications or any application in which the failure of the Vishay product could result in personal injury or death unless specifically qualified in writing by Vishay. Customers using or selling Vishay products not expressly indicated for use in such applications do so at their own risk. Please contact authorized Vishay personnel to obtain written terms and conditions regarding products designed for such applications.

No license, express or implied, by estoppel or otherwise, to any intellectual property rights is granted by this document or by any conduct of Vishay. Product names and markings noted herein may be trademarks of their respective owners.