

47 Series Photo-MOSFET Relay

- Features: High Current Photo MOSFET Relay, switching up to 1.5 Amps
- THT, SMD or SOP; High Temp Available (1050C)
- Tested in accordance with AEC-Q101, UL listed, RoHS Compliance
- Applications: Automatic Test Equipment, Battery Management Systems, I/O Modules, Telephone Equipment
- Markets: Automotive, Telecommunication, Test & Measurement, Security

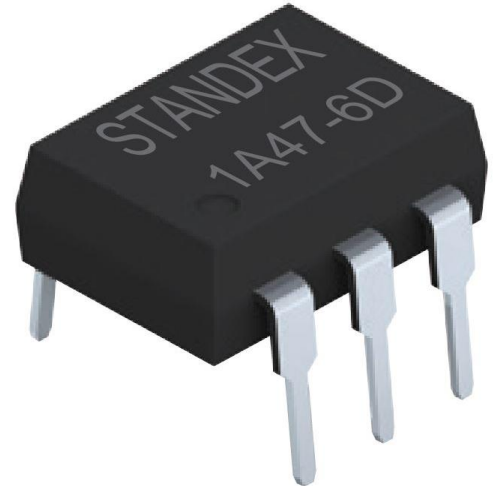

Part Description: SMP-XA47-XXX-X

Number of Poles	Contact Form	Series Number	Number of Pins	Mounting Type	Package Style	Special Features
1, 2	A	47	4, 6, 8	D, S, P	Tube, Reel	Nil, Q, R

See page 7 for Glossary

Maximum Ratings @ Ambient Temperature = 25°C

Parameters	Symbol	Value					Units	Condition
		1A47-4P	2A47-8P	1A47-4D, S	2A47-8D, S	1A47-6D, S		
INPUT SPECIFICATIONS								
Continuous LED Current	I_F	50	50	50	50	50	mA	-
Peak LED Current	I_{FP}	500	500	500	500	500	mA	f=100Hz, 1% Duty Cycle
LED Reverse Voltage	V_R	5	5	5	5	5	V	-
Input Power Dissipation	P_{IN}	75	75	75	75	75	mW	-
OUTPUT SPECIFICATIONS								
Load Voltage	V_L	80	80	80	80	80	DC or Peak AC	-
Load Current	I_L	1.25	1.0	1.25	1.0	1.5	A	-
Peak Load Current	I_{PEAK}	3.0	3.0	3.0	3.0	3.0	A	1 ms, 1 shot
Output Power Dissipation	P_{OUT}	300	450	350	450	500	mW	-
GENERAL SPECIFICATIONS								
Total Power Dissipation	P_T	400	500	400	500	550	mW	-
I/O Breakdown Voltage	$V_{I/O}$	1500	1500	3750	3750	3750	V_{RMS}	-
I/O Breakdown Voltage	$V_{I/O}$	3750	3750	5000	5000	5000	V_{RMS}	Suffix R
Operating Temperature	T_{OPR}	-40/+85	-40/+85	-40/+85	-40/+85	-40/+85	°C	-
Operating Temperature	T_{OPR}	-40/+105	-40/+105	-40/+105	-40/+105	-40/+105	°C	Suffix Q
Storage Temperature	T_{STG}	-40/+100	-40/+100	-40/+100	-40/+100	-40/+100	°C	-



47 Series Photo-MOSFET Relay

Maximum Ratings @ Ambient Temperature = 25°C

Parameters	Symbol	Min	Typ	Max	Units	Condition
INPUT SPECIFICATIONS						
LED Forward Voltage	V_F	1.0	1.37	1.5	V	$I_F = 10\text{mA}$
Operation LED Current	$I_{F\text{ ON}}$	-	1.0	3.0	mA	-
Recovery LED Voltage	$V_{F\text{ OFF}}$	0.5	1.0	-	V	-
OUTPUT SPECIFICATIONS						
On Resistance: Drain to Drain	R_{ON}	-	0.13	0.16	Ω	$I_F = 5\text{mA}, I_L = \text{Rating (within 1 sec.)}$
Off-State Leakage Current	I_{LEAK}	-	-	1.0	μA	$V_L = 80\text{V}$
Output Capacitance	C_{OUT}	-	220	-	ρF	$V_L = 0\text{V}, f = 1\text{MHz}$
TRANSMISSION SPECIFICATIONS						
Turn-On Time	T_{ON}	-	0.4	3.0	ms	$I_F = 5\text{mA}, I_L = \text{Rating (for SOP type)}$
Turn-Off Time	T_{OFF}	-	0.05	0.5	ms	
Turn-On Time	T_{ON}	-	0.3	3.0	ms	$I_F = 10\text{mA}, I_L = \text{Rating (for DIP/SMD type)}$
Turn-Off Time	T_{OFF}	-	0.05	0.5	ms	
COUPLED SPECIFICATIONS						
I/O Insulation Resistance	$R_{\text{I/O}}$	10^9	-	-	Ω	-
I/O Capacitance	$C_{\text{I/O}}$	-	1.3	-	ρF	$f = 1\text{MHz}$

Photo-MOSFET Relay Dimensions (Tolerances acc. to ISO 2768-mp)

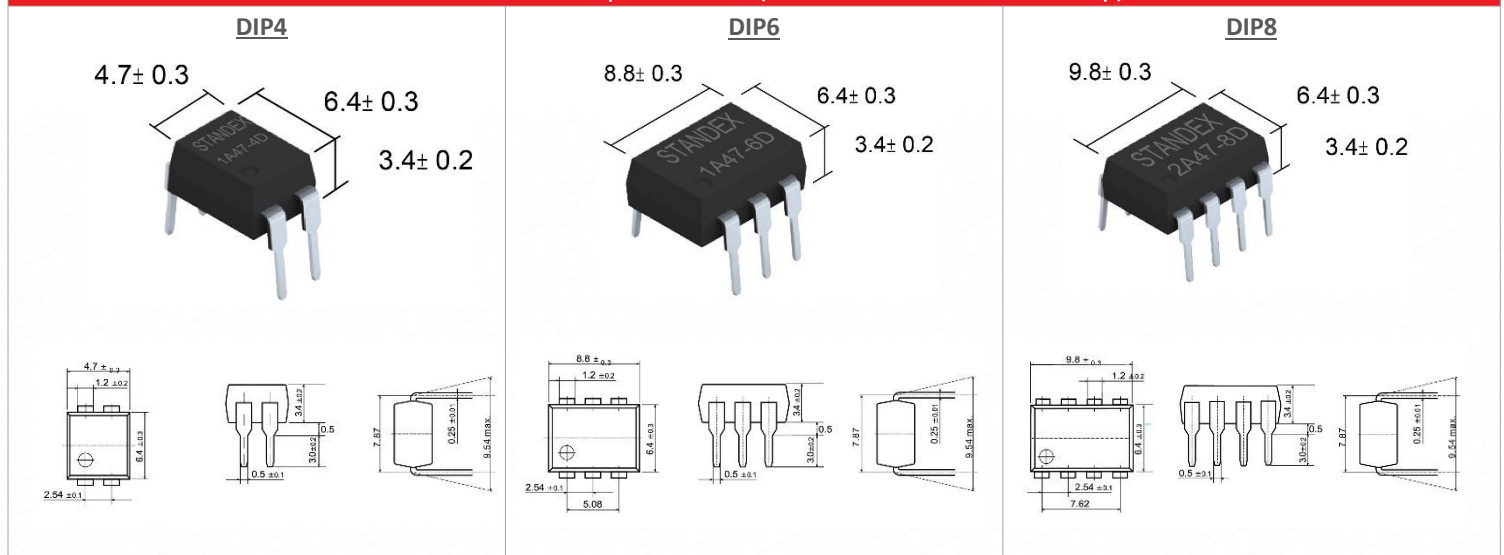

47 Series Photo-MOSFET Relay

Photo-MOSFET Relay Dimensions (Tolerances acc. to ISO 2768-mp)

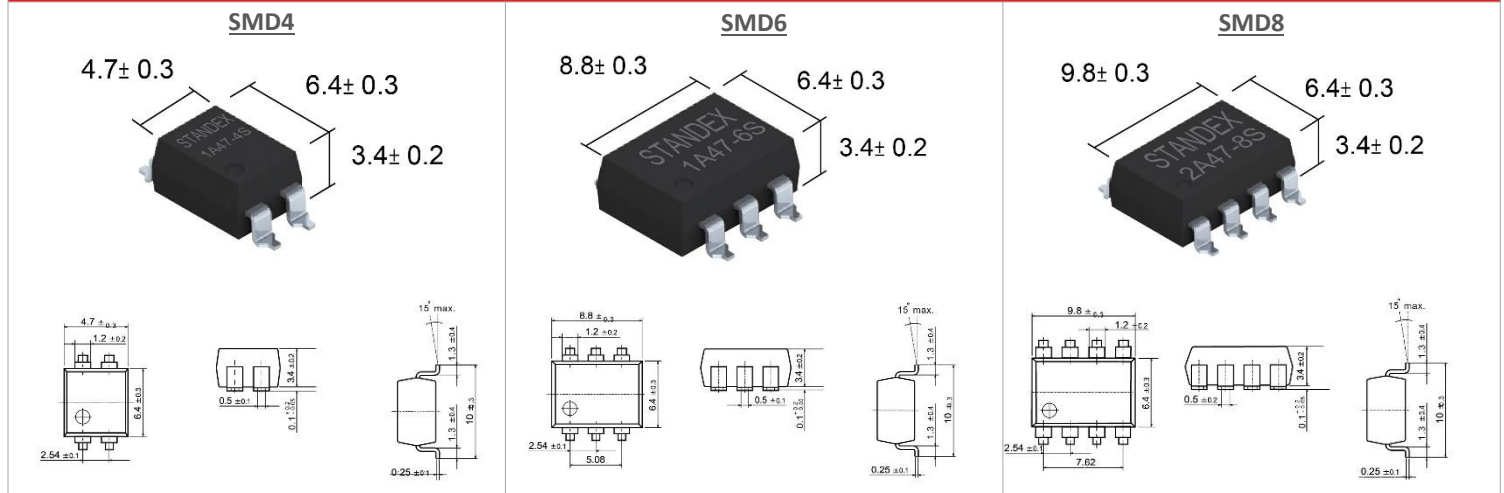

Photo-MOSFET Relay Dimensions (Tolerances acc. to ISO 2768-mp)

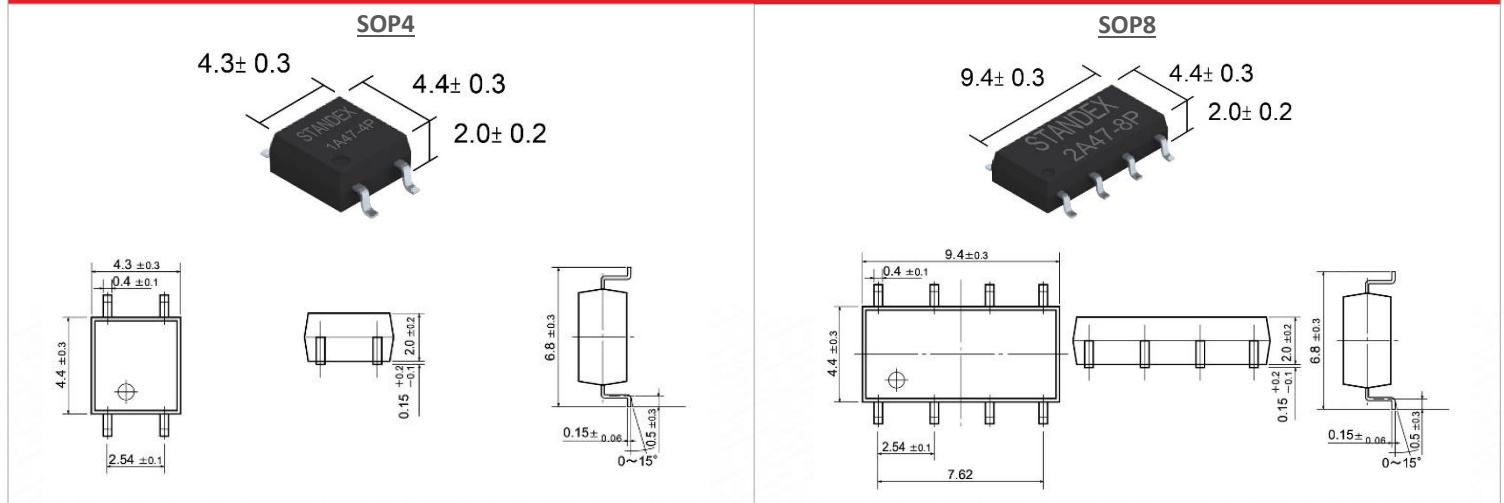
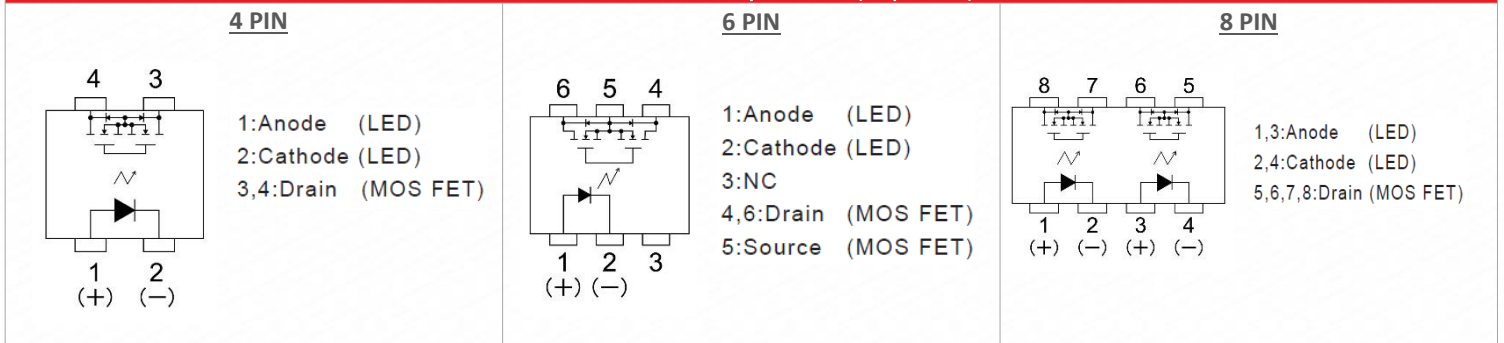

Photo MOSFET Relay Pin-Out (Top View)



47 Series Photo-MOSFET Relay

Photo MOSFET Relay Recommended PCB Pad Layout (Tolerances acc. to ISO 2768-mp)

DIP4 (Bottom View)

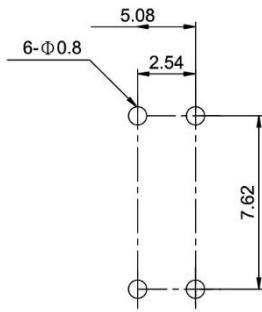

DIP6 (Bottom View)

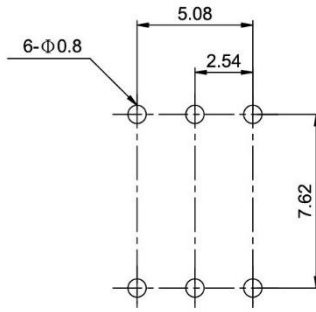

DIP8 (Bottom View)

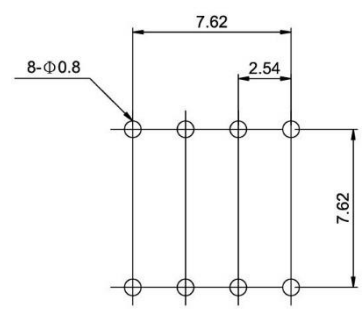

SMD4 (Top View)

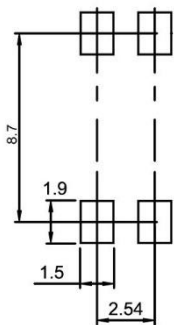

SMD6 (Top View)

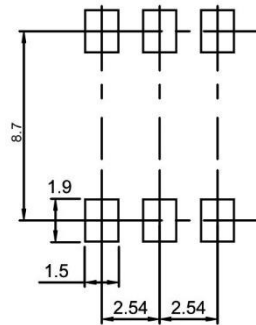

SMD8 (Top View)

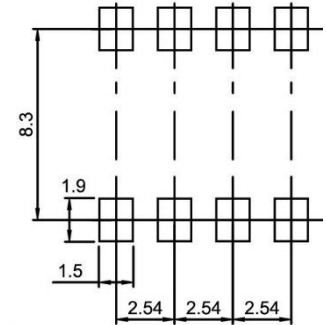

SOP4 (Top View)

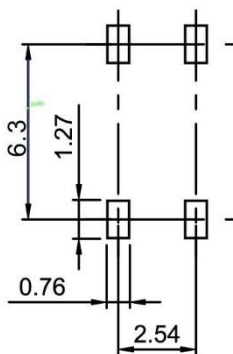

SOP8 (Top View)

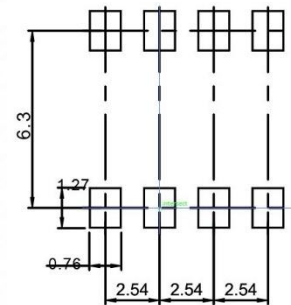

47 Series Photo-MOSFET Relay

Photo MOSFET Relay Reference Data

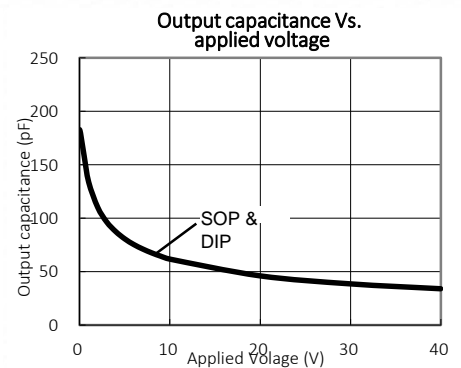
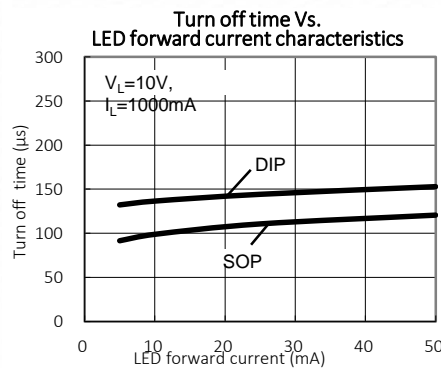
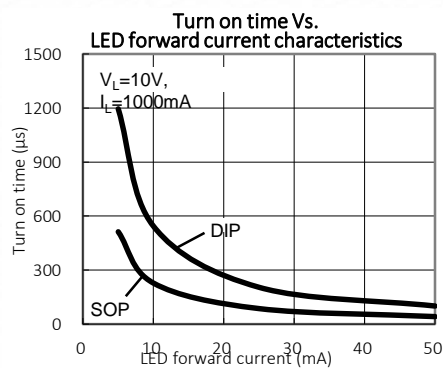
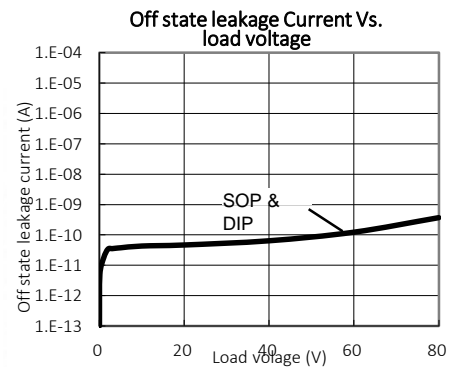
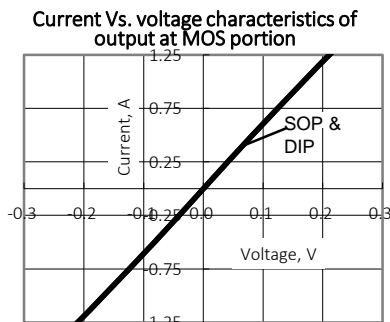
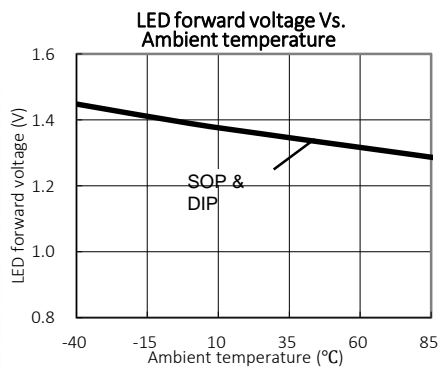
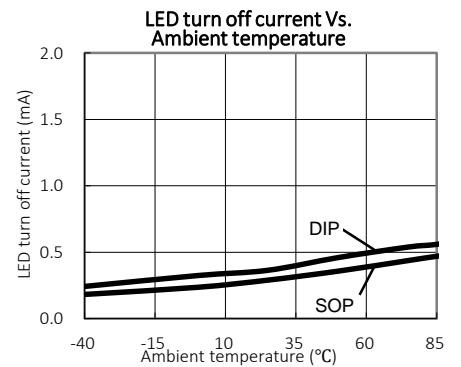
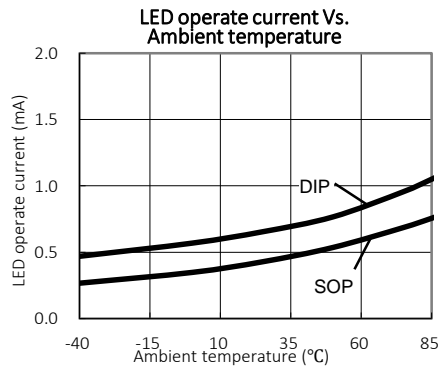
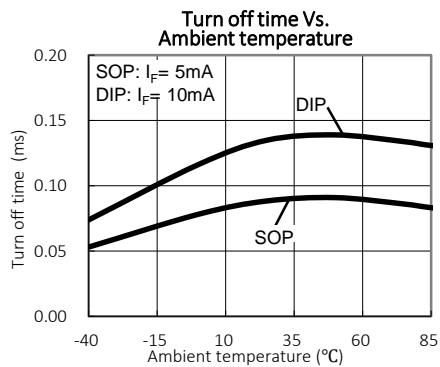
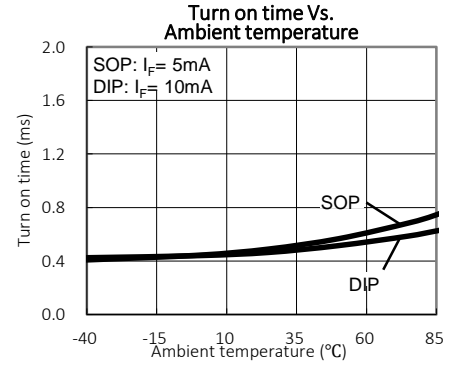
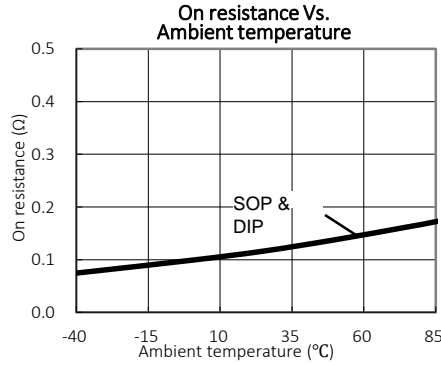
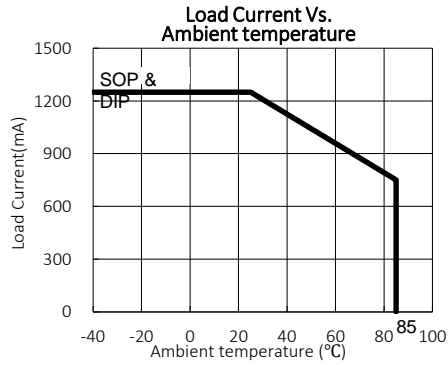

47 Series Photo-MOSFET Relay

Photo MOSFET Relay Tape & Reel Packaging (1,000 pcs per reel)

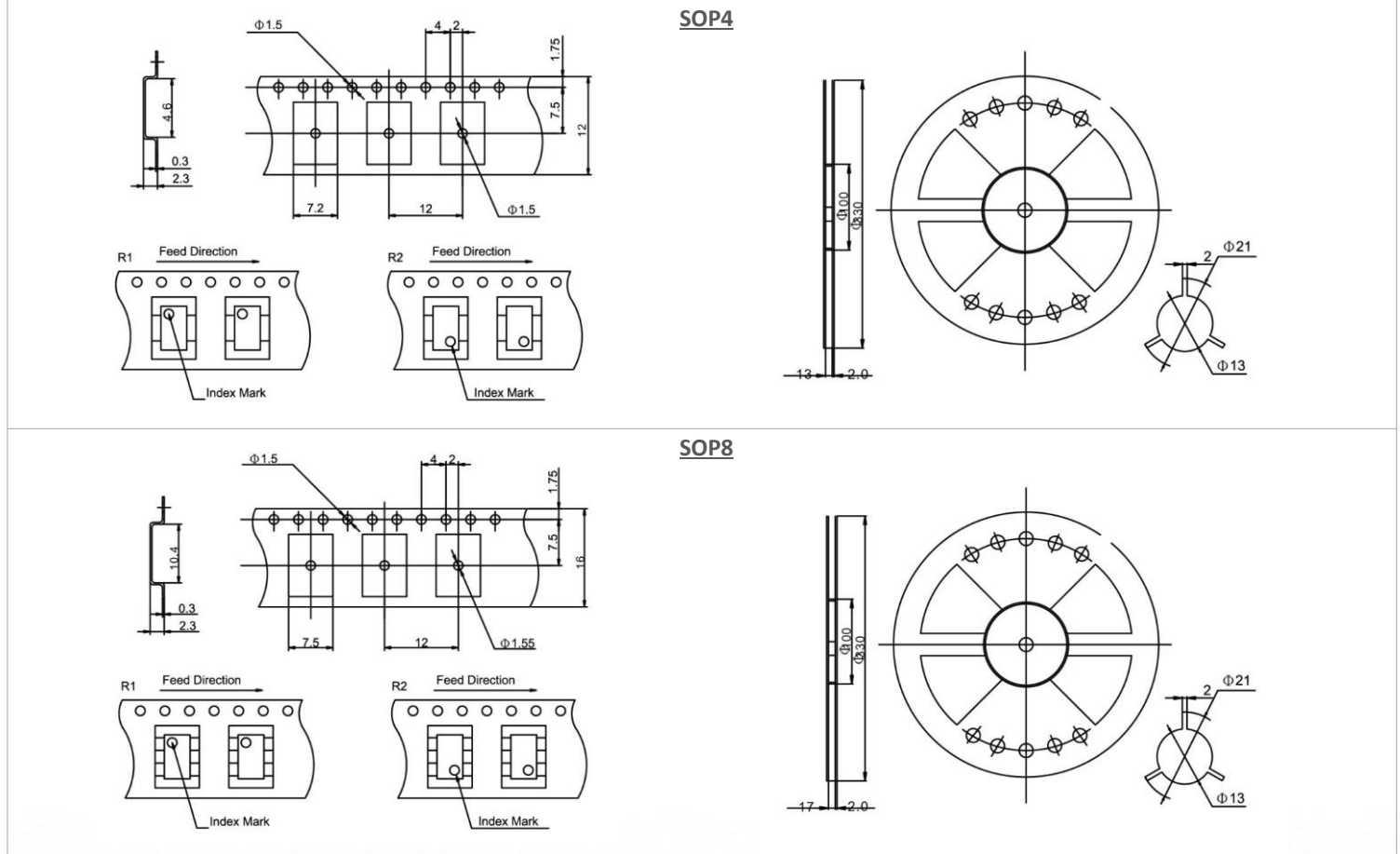

Please note: All technical specifications in this series datasheet refer to the standard product range. Modifications in the sense of technical progress are reserved. For general information only. For more specific information, please consult the product datasheet, available upon request.

This series datasheet could contain technical inaccuracies or typographical errors. Changes are periodically made to the information herein. These changes will be incorporated in future revisions.

For deviating values, latest specifications and product details, please contact your nearest sales office.