



PART SPECIFICATION

Description: CRGV - High Voltage Thick Film Chip Resistors

Tyco Electronics Family

CRGV 0603	1/16W	+/- 1% & 5%	100KΩ ~ 10MΩ	T/R
CRGVP 0603	1/10W-S	+/- 1% & 5%	100KΩ ~ 10MΩ	T/R
CRGV 0805	1/10W	+/- 1% & 5%	100KΩ ~ 10MΩ	T/R
CRGVP 0805	1/8W-S	+/- 1% & 5%	100KΩ ~ 10MΩ	T/R
CRGV 1206	1/8W	+/- 1% & 5%	100KΩ ~ 10MΩ	T/R
CRGVP 1206	1/4W-S	+/- 1% & 5%	100KΩ ~ 10MΩ	T/R
CRGV 2010	1/2W	+/- 1% & 5%	50KΩ ~ 10MΩ	T/R
CRGV 2512	1W	+/- 1% & 5%	50KΩ ~ 10MΩ	T/R

Approved by

Parts corresponding to RoHS Compliant: 2005-Apr.-1

Approved	Checked	Prepared
T Northcott	A. Pile	Subhash M

Rev 2 2013/02/14

CRGV - High Voltage Thick Film Chip Resistors



1. Scope:

This specification for approval relates to High Voltage Thick Film Chip Resistors manufactured by Tyco Electronics specifications.

Moisture Sensitivity Level - MSL1

Note: SMD (Surface mount devices) resistors and inductors should be kept in their original packaging to protect them from ESD (Electrostatic Discharge). The full reels can be broken into smaller quantities, without exposing them to ESD, as long as the components are still in the plastic or paper tape. These resistors and inductors should not be removed from the plastic or paper tape unless they are in an ESD protected environment.

2. Type designation:

The type designation shall be in the following form:

Ex.	Type	Power Rating	Resistance tolerance	Nominal Resistance
	CRGV 0603	1/16W	F - 1% J - 5%	1K0
	CRGVP 0603	1/10W-S		
	CRGV 0805	1/10W		
	CRGVP 0805	1/8W-S		
	CRGV 1206	1/8W		
	CRGVP 1206	1/4W-S		
	CRGV 2010	1/2W		
	CRGV 2512	1W		

3. Ratings:

Type	CRGV0603	CRGV0805	CRGV1206	CRGV2010	CRGV2512	
Power Rating	CRGV	0.0625W	0.10W	0.125W	0.50W	1W
	CRGVP	0.10W	0.125W	0.25W	-	-
Maximum Working Voltage	200 V	400 V	500 V	2000 V	3000 V	
Maximum Overload Voltage	400 V	800 V	1000 V	3000 V	4000 V	
Dielectric Withstanding Voltage	300 V	500 V	500 V	500 V	500 V	
Temperature Range	-55°C +155°C					
Ambient Temperature	70°C					

3.1 Power rating:

Resistors shall have a power rating based on continuous load operation at an ambient temperature of 70°C. For temperature in excess of 70°C, the load shall be derated as shown in figure 1.

Figure 1

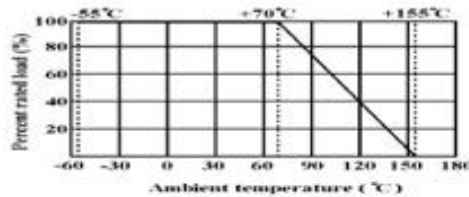

3.2 Voltage Rating:

Resistors shall have a rated direct-current (DC) continuous working voltage or an approximate sine-wave root-mean-square (RMS) alternating-current (AC) continuous working voltage at commercial-line frequency and waveform corresponding to the power rating, as determined from the following formula:

$$RCWV = \sqrt{P \times R}$$

Where: RCWV = Rated DC or RMS AC continuous working voltage at commercial-line frequency and waveform (volt)

P = Power Rating (watt)

R = Nominal Resistance (ohm)

In no case shall the rated DC or RMS AC continuous working voltage be greater than the applicable maximum value.

CRGV - High Voltage Thick Film Chip Resistors



4. Construction :

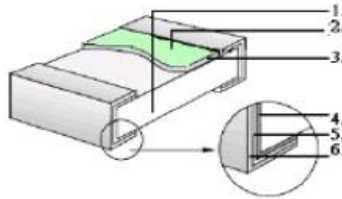

- 1. High purity alumina substrate
- 2. Protective coating
- 3. Resistive element
- 4. Termination (Inner) Ni / Cr
- 5. Termination (Between) Ni barrier
- 6. Termination (Outer) Sn

5. Power rating and dimensions

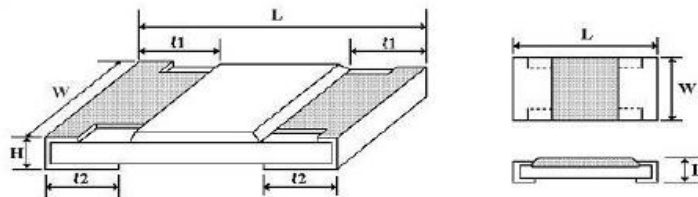

Dimension :

Type	Dimension (mm)				
	L	W	H	t1	t2
0603	1.60 ± 0.10	0.80 + 0.15 - 0.10	0.45 ± 0.10	0.30 ± 0.20	0.30 ± 0.20
0805	2.00 ± 0.15	1.25 + 0.15 - 0.10	0.55 ± 0.10	0.40 ± 0.20	0.40 ± 0.20
1206	3.10 ± 0.15	1.55 + 0.15 - 0.10	0.55 ± 0.10	0.45 ± 0.20	0.45 ± 0.20
2010	5.00 ± 0.10	2.50 + 0.15 - 0.10	0.55 ± 0.10	0.60 ± 0.25	0.50 ± 0.20
2512	6.35 ± 0.10	3.20 + 0.15 - 0.10	0.55 ± 0.10	0.60 ± 0.25	0.50 ± 0.20

Power Rating :

Type	Power Rating at 70°C	Tolerance %	Resistance Range	Standard Series
0603	0.10W-S 0.0625W	± 1	100KΩ ~ 10MΩ	E-96
		± 5	100KΩ ~ 10MΩ	E-24
0805	0.125W-S 0.1W	± 1	100KΩ ~ 10MΩ	E-96
		± 5	100KΩ ~ 10MΩ	E-24
1206	0.25W-S 0.125W	± 1	100KΩ ~ 10MΩ	E-96
		± 5	100KΩ ~ 10MΩ	E-24
2010	0.50W	± 1	50KΩ ~ 10MΩ	E-96
		± 5	50KΩ ~ 10MΩ	E-24
2512	1W	± 1	50KΩ ~ 10MΩ	E-96
		± 5	50KΩ ~ 10MΩ	E-24

CRGV - High Voltage Thick Film Chip Resistors



6. Marking :

6.1 Resistors

A. ± 5% Tolerance 0603, 0805, 1206, 2010, 2512: the first two digits are significant figure of resistance and the third onedenoted number of zeros.



B. For ohmic values below 10 Ω



C. For E-96 series [±1% (F) tolerance] in 0603 size 3 digit system (due to space restrictions) please refer to page 8 for coding formula

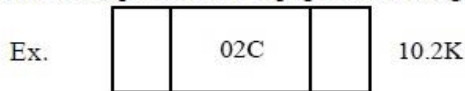

D. ±1% Tolerance 0805, 1206, 2010, 2512: 4 Digits, the first three digits are significant figures of resistance and the fourth digit denoted number of zeros

Letter "R" is for decimal point.

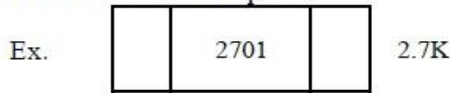



6.2 Labels

Label shall be marked with the following item :

Label shall be marked with the following item :

- A. Nominal Resistance and Resistance Tolerance
- B. Power Rating and Size
- C. Quantity
- D. Part No.
- E. P.O.No.
- F. Lot No.

tyco / Electronics			
CHIP RESISTORS			
RESISTANCE:	100K	Ω	± 5 %
WATTAGE:	1/4W-S	SIZE:	CRGV1206
QUANTITY:	5,000	PCS	Pb-Free
PART NO.:	1879535-1	RoHS	2002/95/EC
LOT NO.:	1234567	REF #	1234567389
			

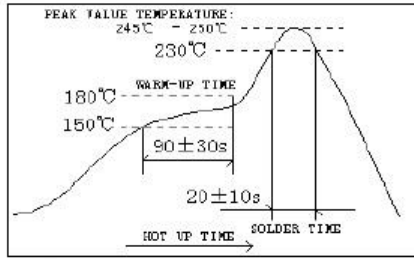
High Voltage Thick Film Chip Resistors																	
7. Performance specification :																	
Characteristics	Limits	Test Methods (JIS C 5201-1)															
Temperature Coefficient	± 200 PPM/°C	4.8 Natural resistance change per temp. degree centigrade. $\frac{R_2 - R_1}{R_1(t_2 - t_1)} \times 10^6 \text{ (PPM/°C)}$ R1: Resistance value at room temperature (t1) R2: Resistance value at room temp. plus 100 °C (t2) Test pattern : Room Temperature(t1), Room temperature +100°C (t2)															
Short time overload	Resistance change rate is ±(2.0%+0.1Ω) Maximum	4.13 Permanent resistance change after the application of a potential of 2.5 times RCWV for 5 seconds															
Solderability	95 % coverage Minimum	Test temperature of solder : 245 ± 3°C Dipping time in solder : 2~3 seconds															
	Go up tin rate bigger than half of end pole.	Reflow: 															
Temperature cycling	Resistance change rate is ± 5% (1.0% + 0.05 Ω) Maximum ± 1% (0.5% + 0.05 Ω) Maximum	4.19 Resistance change after continuous 5 cycles for duty cycle specified below :															
		<table border="1"> <thead> <tr> <th>Step</th> <th>Temperature</th> <th>Time</th> </tr> </thead> <tbody> <tr> <td>1</td> <td>-55°C ± 3°C</td> <td>30 mins</td> </tr> <tr> <td>2</td> <td>Room temp.</td> <td>10~15 mins</td> </tr> <tr> <td>3</td> <td>+155°C ± 2°C</td> <td>30 mins</td> </tr> <tr> <td>4</td> <td>Room temp.</td> <td>10~15 mins</td> </tr> </tbody> </table>	Step	Temperature	Time	1	-55°C ± 3°C	30 mins	2	Room temp.	10~15 mins	3	+155°C ± 2°C	30 mins	4	Room temp.	10~15 mins
		Step	Temperature	Time													
		1	-55°C ± 3°C	30 mins													
		2	Room temp.	10~15 mins													
3	+155°C ± 2°C	30 mins															
4	Room temp.	10~15 mins															
Humidity (Steady State)	Resistance change rate is ±(3.0%+0.1Ω) Maximum	4.24 Temporary resistance change after 1,000 hours exposure in a humidity test chamber controlled at 40±2°C and 90~95% relative humidity															
Load life in Humidity	Resistance change rate is ±(3.0%+0.1Ω) Maximum	7.9 Resistance change after 1,000 hours (1.5 hours "on", 0.5 hour "off") at RCWV in a humidity chamber controlled at 40°C ± 3°C and 90 to 95 % relative humidity															
Load Life	Resistance change rate is ±(3.0%+0.1Ω)Max.	4.25.1 Permanent resistance change after 1,000 hours at RCWV, with duty cycle 1.5 hours"on", 0.5 hour"off" at 70°C ± 2°C ambient															
Terminal Bending	Resistance change rate is ±(1.0%+0.05Ω)Max.	4.33 Twist of Test Board : Y/X = 3/90 mm for 60 seconds															

High Voltage Thick Film Chip Resistors



6. Packing specification :

6.1 Taping Dimension (mm)

A. Paper taping

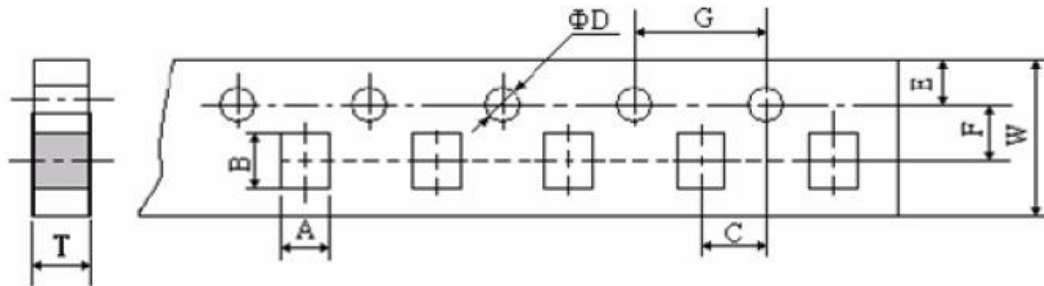

Type	A ± 0.2	B ± 0.2	C ± 0.05	$\phi D^{+0.1}$ -0	E ± 0.1	F ± 0.05	G ± 0.1	W ± 0.2	T ± 0.1
0603	1.10	1.90	2.0	1.5	1.75	3.5	4.0	8.0	0.67
0805	1.65	2.40	2.0	1.5	1.75	3.5	4.0	8.0	0.81
1206	2.00	3.60	2.0	1.5	1.75	3.5	4.0	8.0	0.81
2010	2.80	5.40	2.0	1.5	1.75	5.5	4.0	12.0	0.75

B. Embossed taping

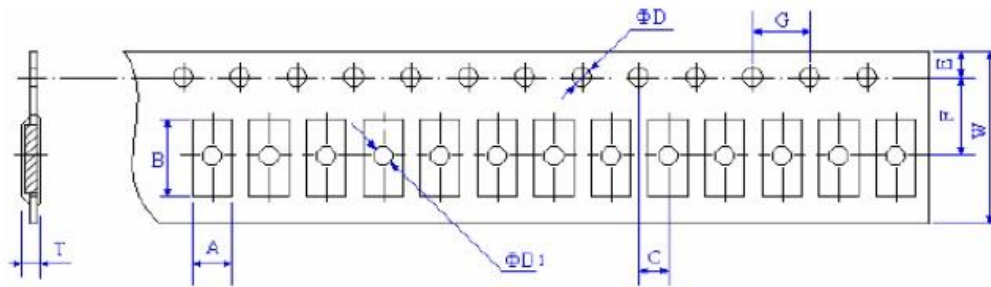

Type	A ± 0.2	B ± 0.2	C ± 0.05	$\phi D^{+0.1}$ -0	E ± 0.1	F ± 0.05	G ± 0.1	W ± 0.2	$\phi D1^{+0.1}$ -0
2512	3.50	6.70	2.0	1.5	1.75	5.5	4.0	12.0	1.0

High Voltage Thick Film Chip Resistors



7.2 Reel Dimension (mm)

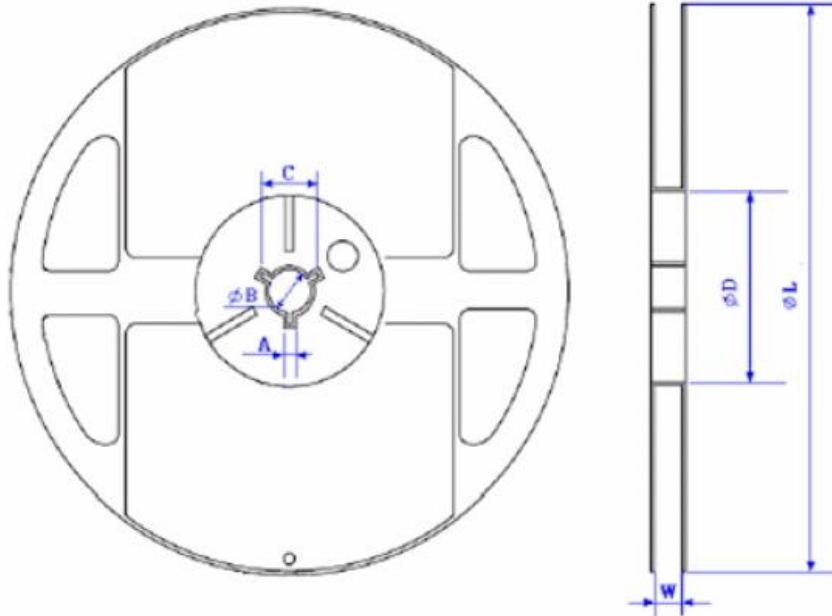

Type	Packaging	Quantity Per Reel	A \pm 0.5	B \pm 0.5	C \pm 0.5	D \pm 1	M \pm 2	W \pm 1
0603	Paper	5,000 pcs.	2	13	21	60	178	10
0805	Paper	5,000 pcs.	2	13	21	60	178	10
1206	Paper	5,000 pcs.	2	13	21	60	178	10
2010	Paper	4,000 pcs.	2	13	21	60	178	13.8
2512	Embossed	4,000 pcs.	2	13	21	60	178	13.8



CRGV - High Voltage Thick Film Chip Resistors



Explanation of Part Number System

