



Part Number : [528072110](#)

Product Description : 1.00mm Pitch Easy-On FFC/
FPC Connector, Right-Angle, Non-ZIF, Top Contact Style
Receptacle, 21 Circuits

Series Number : 52807

Status : Not Recommended For New Design

Product Category : FFC / FPC Connectors

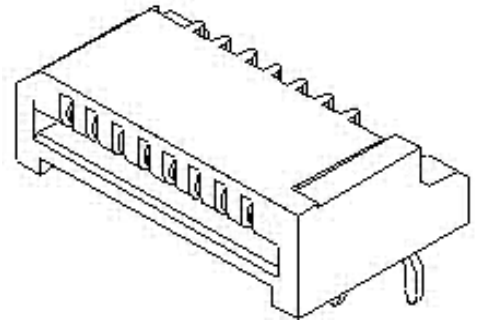

Documents and Resources

Drawings

[528072110 sd.pdf](#)

3D Models and Design Files

[STEP AP242](#)

[SOLIDWORKS](#)

[Creo](#)

Specifications

[SPK-52807-001-001.pdf](#)

[PS-52807-003-001.pdf](#)

Product Environment Compliance

Compliance

GADSL/IMDS	Compliant with Exemption 44
China RoHS	 per SJ/T 11365-2006
EU ELV	Not Relevant
Low-Halogen Status	Not Low-Halogen per IEC 61249-2-21
REACH SVHC	Not Contained per D(2025)6375-DC (05 Nov 2025)
EU RoHS	Compliant per EU 2015/863

Compliance Statements

- EU RoHS

- REACH SVHC
- Low-Halogen

Industry Documents

- IPC 1752A Class C
- IPC 1752A Class D
- Molex Product Compliance Declaration
- IEC-62474
- chemSHERPA (xml)

Substances of Interest

- PFAS

EU RoHS Certificate of Compliance

Additional Product Compliance Information

Part Details

General

Status	Not Recommended For New Design
Category	FFC / FPC Connectors
Series	52807
Description	1.00mm Pitch Easy-On FFC/FPC Connector, Right-Angle, Non-ZIF, Top Contact Style Receptacle, 21 Circuits
Product Name	Easy-On
UPC	800753360990

Agency

UL	E29179
----	--------

Electrical

Current - Maximum per Contact	0.2A, 0.4A, 0.5A
Voltage - Maximum	50V

Physical

Actuator Type	Non-ZIF
Circuits (Loaded)	21
Color - Resin	Natural

Contact Position	Top
Mated Height	3.60mm
Material - Metal	Phosphor Bronze
Material - Plating Mating	Tin
Material - Plating Termination	Tin
Material - Resin	High Temperature Thermoplastic
Net Weight	647.201/mg
Orientation	Right Angle
Packaging Type	Tray
PCB Mounting	Through Hole - Kinked Pin
PCB Retention	None
PC Tail Length	3.20mm
Pitch - Mating Interface	1.00mm
Pitch - Termination Interface	1.00mm
Plating min - Mating	0.914µm
Plating min - Termination	0.914µm
Polarized to PCB	Yes
Stackable	No
Temperature Range - Operating	-20° to +80°C
Wire/Cable Type	FFC/FPC

Mates With / Use With

Mates with Part(s)

Description	Part Number
1.00mm Pitch Premo-Flex FFC Jumpers	<u>15167</u>
1.00mm Pitch Premo-Flex FFC Jumpers	<u>15267</u>
1.00mm Pitch Premo-Flex FFC Jumpers	<u>98267</u>

This document was generated on Jan 01, 2026