

2600 series

Power rocker switches



DISTINCTIVE FEATURES

Three rocker shapes : plain, V-shaped or concave

Various rocker colors

Frame with protection guard on 2600LP models

Illuminated or non-illuminated

UL, CSA, VDE and NF (EN 61058-1) approved



ELECTRICAL SPECIFICATIONS

- Max. current/voltage rating with resistive load and approved ratings : see table below.
- Initial contact resistance : 10 mΩ max.
- Insulation resistance : 1,000 MΩ min. at 500 VDC
- Dielectric strength : 2,500 Vrms 50 Hz min. between terminals
3,000 Vrms 50 Hz min. between terminals and metal panel
- Electrical life : 10,000 cycles at full load

Functions	APPROVED RATINGS				DIRECT CURRENT	
	CSA (double pole)	UL (double pole)	VDE	NF	24 VDC	12 VDC
	CSA 22-2	UL 1054	EN 61058-1	EN 61058-1		
ON - OFF ON - ON	1/6 HP 125 VAC 16 A 125 VAC 16 A 250 VAC 1/3 HP 250 VAC	1/6 HP 125 VAC 16 A 125 VAC 16 A 250 VAC 1/3 HP 250 VAC	10(4) A 250 VAC T 85/55	-	10 A	15 A
ON - OFF - ON	10 A 125 VAC 10 A 250 VAC 1/6 HP 125/250 VAC	10 A 125 VAC 10 A 250 VAC 1/6 HP 125/250 VAC	L I option 10(4) A 250 VAC	L I option 10(4) A 250 VAC	8 A	10 A
ON - ON - ON	-	-	-	-	5 A	8 A
OTHERS	10 A 125 VAC 10 A 250 VAC 1/6 HP 250 VAC	-	L I option 10(4) A 250 VAC	L I option 10(4) A 250 VAC	8 A	10 A



GENERAL SPECIFICATIONS

- Panel thickness : 0.8 mm to 4 mm (.031 to .157)
- Operating temperature :
 - silver contacts (A) : -20 °C to +85 °C (-4 °F to +185 °F)
 - silver plated contacts (C) : -10 °C to +55 °C (+14 °F to +131 °F)

The company reserves the right to change specifications without notice.



2600 series

Power rocker switches



MATERIALS

- Case : melamine/polyester
- Frame : polyamide
- Actuator : polyamide
- Contacts :
 - A : silver
 - C : copper, silver plated

AGENCY APPROVALS



EN 61058-1 EN 61058-1

Availability : consult factory for details of approved models.
Marking : approved models are standard marked.



TERMINALS

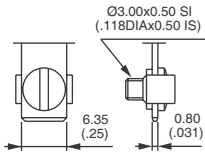

Screw

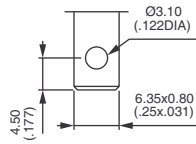

Solder lug / quick-connect

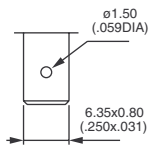

Normalized quick-connect



ELECTRICAL FUNCTIONS

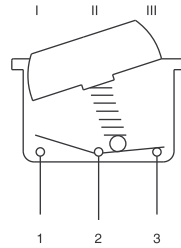

PANEL CUT-OUT

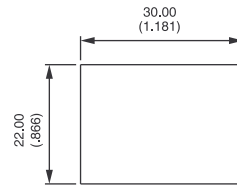

2600 series

Power rocker switches



BUILD YOUR PART NUMBER

BASIC PART NUMBER

26																																										
SERIES	NUMBER OF POLES	ELECTRICAL FUNCTIONS			TERMINALS																																					
	<table border="1"> <tr><td>3</td><td>Single pole</td></tr> <tr><td>4</td><td>Double pole</td></tr> </table>	3	Single pole	4	Double pole	<table border="1"> <tr><td>1</td><td>ON</td><td>-</td><td>OFF</td></tr> <tr><td>4</td><td>ON</td><td>ON</td><td>ON ▲</td></tr> <tr><td>5</td><td>MOM</td><td>-</td><td>ON</td></tr> <tr><td>6</td><td>ON</td><td>-</td><td>ON</td></tr> </table>	1	ON	-	OFF	4	ON	ON	ON ▲	5	MOM	-	ON	6	ON	-	ON	<table border="1"> <tr><td>7</td><td>MOM</td><td>OFF</td><td>MOM</td></tr> <tr><td>8</td><td>ON</td><td>OFF</td><td>MOM</td></tr> <tr><td>9</td><td>ON</td><td>OFF</td><td>ON</td></tr> </table>	7	MOM	OFF	MOM	8	ON	OFF	MOM	9	ON	OFF	ON	<table border="1"> <tr><td>(none)</td><td>Screw + clamp</td></tr> <tr><td>/2</td><td>Solder lugs / quick-connect</td></tr> <tr><td>/3</td><td>Normalized quick-connect</td></tr> </table>	(none)	Screw + clamp	/2	Solder lugs / quick-connect	/3	Normalized quick-connect
3	Single pole																																									
4	Double pole																																									
1	ON	-	OFF																																							
4	ON	ON	ON ▲																																							
5	MOM	-	ON																																							
6	ON	-	ON																																							
7	MOM	OFF	MOM																																							
8	ON	OFF	MOM																																							
9	ON	OFF	ON																																							
(none)	Screw + clamp																																									
/2	Solder lugs / quick-connect																																									
/3	Normalized quick-connect																																									
		▲ double pole only			FRAME TYPE																																					
					<table border="1"> <tr><td>LH</td><td>Plain</td></tr> <tr><td>LP</td><td>With protection guard</td></tr> </table>	LH	Plain	LP	With protection guard																																	
LH	Plain																																									
LP	With protection guard																																									

OPTIONS

	FRAME COLORS	ROCKER SHAPES	ROCKER MARKING		ILLUMINATED WINDOW																																																																				
	<table border="1"> <tr><td>1</td><td>dark blue</td></tr> <tr><td>2</td><td>black (standard)</td></tr> <tr><td>4</td><td>grey</td></tr> <tr><td>7/1</td><td>white</td></tr> <tr><td>8</td><td>chrome plated</td></tr> <tr><td>B</td><td>light brown</td></tr> <tr><td>E</td><td>dark brown</td></tr> </table>	1	dark blue	2	black (standard)	4	grey	7/1	white	8	chrome plated	B	light brown	E	dark brown	<table border="1"> <tr><td>1</td><td>Plain</td></tr> <tr><td>2</td><td>V-shaped</td></tr> <tr><td>3</td><td>Concave</td></tr> </table>	1	Plain	2	V-shaped	3	Concave	<table border="1"> <thead> <tr><th colspan="2">Black</th><th colspan="2">White</th><th></th></tr> </thead> <tbody> <tr><td>00</td><td>00</td><td colspan="2">(none)</td><td></td></tr> <tr><td>01</td><td>21</td><td>O</td><td>—</td><td></td></tr> <tr><td>07</td><td>27</td><td>O</td><td>I</td><td></td></tr> <tr><td>08</td><td>28</td><td>ON</td><td>OFF</td><td></td></tr> </tbody> </table> <p>Complete table at the end of the series.</p>		Black		White			00	00	(none)			01	21	O	—		07	27	O	I		08	28	ON	OFF		<table border="1"> <tr><td>/3</td><td>green</td></tr> <tr><td>/6</td><td>red</td></tr> </table> <p>With green, use fluorescent lamp only.</p>	/3	green	/6	red																			
1	dark blue																																																																								
2	black (standard)																																																																								
4	grey																																																																								
7/1	white																																																																								
8	chrome plated																																																																								
B	light brown																																																																								
E	dark brown																																																																								
1	Plain																																																																								
2	V-shaped																																																																								
3	Concave																																																																								
Black		White																																																																							
00	00	(none)																																																																							
01	21	O	—																																																																						
07	27	O	I																																																																						
08	28	ON	OFF																																																																						
/3	green																																																																								
/6	red																																																																								
CONTACT MATERIALS		ROCKER COLORS			LAMPS																																																																				
<table border="1"> <tr><td>A</td><td>Silver</td></tr> <tr><td>C</td><td>Copper, silver plated (functions 1, 6 and 9 only)</td></tr> </table>	A	Silver	C	Copper, silver plated (functions 1, 6 and 9 only)	<table border="1"> <thead> <tr><th colspan="2">Illuminated rocker (without window)</th></tr> </thead> <tbody> <tr><td>0</td><td>Without rocker</td></tr> <tr><td>1</td><td>blue</td></tr> <tr><td>3</td><td>green</td></tr> <tr><td>5</td><td>yellow</td></tr> <tr><td>6</td><td>red</td></tr> <tr><td>7/1</td><td>white</td></tr> <tr><td>9</td><td>orange</td></tr> </tbody> </table> <p>With green or blue rocker, use fluorescent lamp only.</p>	Illuminated rocker (without window)		0	Without rocker	1	blue	3	green	5	yellow	6	red	7/1	white	9	orange	<table border="1"> <thead> <tr><th colspan="2">Non-illuminated rocker or rocker with illum. window •</th></tr> </thead> <tbody> <tr><td>0</td><td>Without rocker</td></tr> <tr><td>02</td><td>light brown</td></tr> <tr><td>04</td><td>dark brown</td></tr> <tr><td>03</td><td>beige</td></tr> <tr><td>10</td><td>blue</td></tr> <tr><td>14</td><td>dark blue</td></tr> <tr><td>20</td><td>black •</td></tr> <tr><td>30</td><td>green •</td></tr> <tr><td>40</td><td>grey</td></tr> <tr><td>50</td><td>yellow</td></tr> <tr><td>60</td><td>red •</td></tr> <tr><td>70</td><td>white</td></tr> <tr><td>90</td><td>orange</td></tr> </tbody> </table>		Non-illuminated rocker or rocker with illum. window •		0	Without rocker	02	light brown	04	dark brown	03	beige	10	blue	14	dark blue	20	black •	30	green •	40	grey	50	yellow	60	red •	70	white	90	orange	<table border="1"> <tr><td>L0</td><td>Without lamp</td></tr> <tr><td>L6V</td><td>6 V filament lamp</td></tr> <tr><td>L12V</td><td>12 V filament lamp</td></tr> <tr><td>L24V</td><td>24 V filament lamp</td></tr> <tr><td>L110V</td><td>110 VAC neon lamp</td></tr> <tr><td>L110V1</td><td>110 VAC blue fuor. lamp</td></tr> <tr><td>L110V3</td><td>110 VAC green fuor. lamp</td></tr> <tr><td>L220V</td><td>220 VAC neon lamp</td></tr> <tr><td>L220V1</td><td>220 VAC blue fuor. lamp</td></tr> <tr><td>L220V3</td><td>220 VAC green fuor. lamp</td></tr> </table>	L0	Without lamp	L6V	6 V filament lamp	L12V	12 V filament lamp	L24V	24 V filament lamp	L110V	110 VAC neon lamp	L110V1	110 VAC blue fuor. lamp	L110V3	110 VAC green fuor. lamp	L220V	220 VAC neon lamp	L220V1	220 VAC blue fuor. lamp	L220V3	220 VAC green fuor. lamp	
A	Silver																																																																								
C	Copper, silver plated (functions 1, 6 and 9 only)																																																																								
Illuminated rocker (without window)																																																																									
0	Without rocker																																																																								
1	blue																																																																								
3	green																																																																								
5	yellow																																																																								
6	red																																																																								
7/1	white																																																																								
9	orange																																																																								
Non-illuminated rocker or rocker with illum. window •																																																																									
0	Without rocker																																																																								
02	light brown																																																																								
04	dark brown																																																																								
03	beige																																																																								
10	blue																																																																								
14	dark blue																																																																								
20	black •																																																																								
30	green •																																																																								
40	grey																																																																								
50	yellow																																																																								
60	red •																																																																								
70	white																																																																								
90	orange																																																																								
L0	Without lamp																																																																								
L6V	6 V filament lamp																																																																								
L12V	12 V filament lamp																																																																								
L24V	24 V filament lamp																																																																								
L110V	110 VAC neon lamp																																																																								
L110V1	110 VAC blue fuor. lamp																																																																								
L110V3	110 VAC green fuor. lamp																																																																								
L220V	220 VAC neon lamp																																																																								
L220V1	220 VAC blue fuor. lamp																																																																								
L220V3	220 VAC green fuor. lamp																																																																								
					L I OPTION																																																																				
					<table border="1"> <tr><td>L I</td><td>EN 61058-1 approved version, without lamp (3 position switches)</td></tr> </table>	L I	EN 61058-1 approved version, without lamp (3 position switches)																																																																		
L I	EN 61058-1 approved version, without lamp (3 position switches)																																																																								

NOTICE : please note that not all combinations of above numbers are available. Refer to the following pages for further information.

2600 series

Power rocker switches

2600LH - SINGLE POLE



Screw term. + clamp	Solder lug/ quick-connect	III A2-A1	II	I A2-A3
2631LH	2631LH/2	ON	-	OFF
2635LH	2635LH/2	MOM	-	ON
2636LH	2636LH/2	ON	-	ON
2637LH	2637LH/2	MOM	OFF	MOM
2638LH	2638LH/2	ON	OFF	MOM
2639LH	2639LH/2	ON	OFF	ON

2600LH - DOUBLE POLE



Screw term. + clamp	Solder lug/ quick-connect	III A2-A1 B5-B4	II	I A2-A3 B5-B6
2641LH	2641LH/2	ON	-	OFF
2644LH*	2644LH/2*	ON	ON	ON
2645LH	2645LH/2	MOM	-	ON
2646LH	2646LH/2	ON	-	ON
2647LH	2647LH/2	MOM	OFF	MOM
2648LH	2648LH/2	ON	OFF	MOM
2649LH	2649LH/2	ON	OFF	ON

2600LP - WITH PROTECTION GUARD SINGLE POLE



Screw term. + clamp	Solder lug/ quick-connect	III A2-A1	II	I A2-A3
2631LP	2631LP/2	ON	-	OFF
2635LP	2635LP/2	MOM	-	ON
2636LP	2636LP/2	ON	-	ON
2637LP	2637LP/2	MOM	OFF	MOM
2638LP	2638LP/2	ON	OFF	MOM
2639LP	2639LP/2	ON	OFF	ON

2600LP - WITH PROTECTION GUARD DOUBLE POLE



Screw term. + clamp	Solder lug/ quick-connect	III A2-A1 B5-B4	II	I A2-A3 B5-B6
2641LP	2641LP/2	ON	-	OFF
2644LP*	2644LP/2*	ON	ON	ON
2645LP	2645LP/2	MOM	-	ON
2646LP	2646LP/2	ON	-	ON
2647LP	2647LP/2	MOM	OFF	MOM
2648LP	2648LP/2	ON	OFF	MOM
2649LP	2649LP/2	ON	OFF	ON

Shown with plain rocker

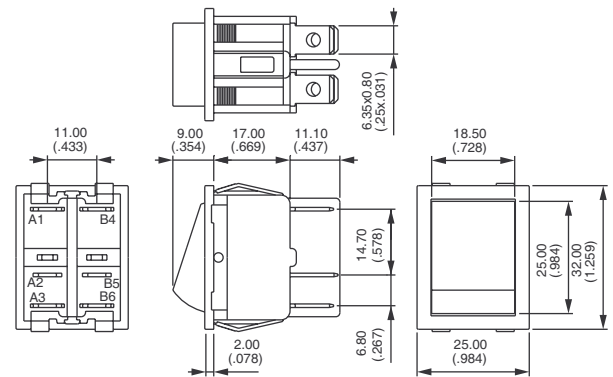
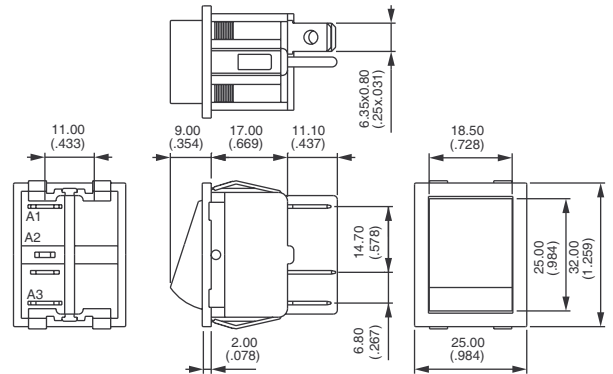

*Function 4 : SP in DP case, see "Technical information" on website.

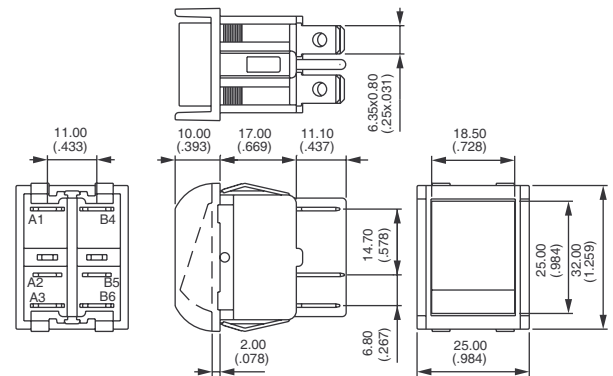
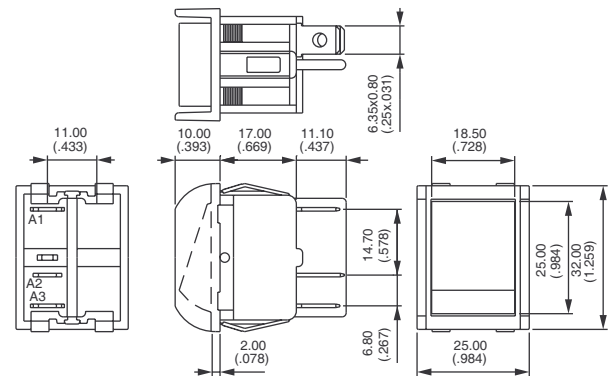

*Function 4 : SP in DP case, see "Technical information" on website.

2600 series

Power rocker switches

TERMINAL OPTION

Specify after LH or LP.

/3 Normalized quick-connect terminals 6.35 x 0.8 (.250 x .031)

CONTACT MATERIALS

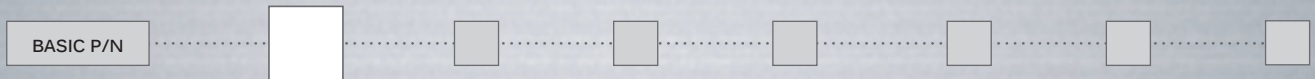

- A Silver
- C Copper, silver plated (available with functions 1, 6 and 9 only)

FRAME COLORS

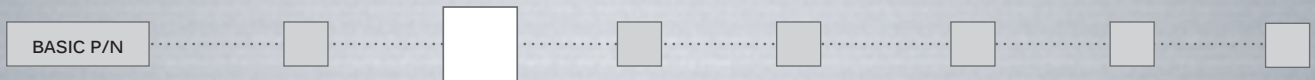

- 1 Dark blue
- 2 Black (standard)
- 4 Grey
- 7/1 White/natural
- 8 Chrome plated (⚠️ Chrome plated option has UL approval only.)
- B Light brown
- E Dark brown

FRAME COLORS

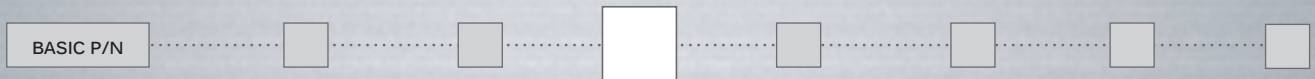

- 1 Plain
- 2 V-shaped
- 3 Concave

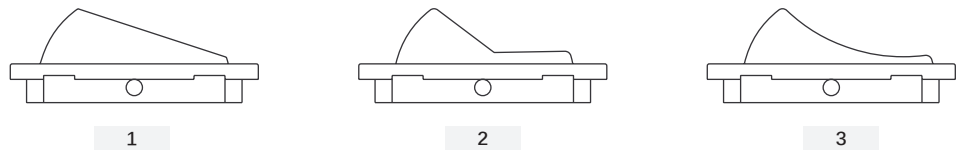

ROCKER COLORS

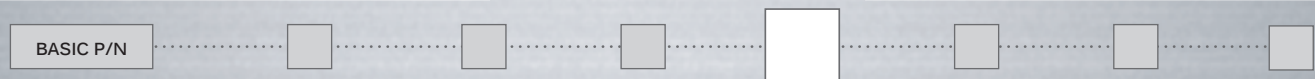

FOR ILLUMINATED SWITCHES

		Plain rocker P/N	V-shaped rocker P/N	Concave rocker P/N
0	Without rocker	-	-	-
1	Blue*	U881	U861	U871
3	Green*	U883	U863	U873
5	Yellow	U885	U865	U875
6	Red	U886	U866	U876
7/1	white	U887	U867	U877
9	Orange	U889	U869	U879

* With green or blue rocker, use fluorescent lamp only.

2600 series

Power rocker switches

ROCKER COLORS (CONTINUED)

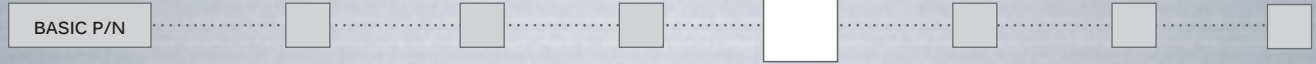

FOR NON-ILLUMINATED SWITCHES OR SWITCHES WITH ILLUMINATED WINDOW (•)

		Plain rocker P/N	V-shaped rocker P/N	Concave rocker P/N
0	Without rocker	-	-	-
02	Light brown	U1250B	U1270B	U1260B
04	Dark brown	U1250BF	U1270BF	U1260BF
03	Beige	U1250	U1270B	U1260B
10	Blue	U1251	U1271	U1261
14	Dark blue	U1251/4	U1271/4	U1261/4
20 •	Black	U1252	U1272	U1262
30 •	Green	U1253	U1273	U1263
40	Grey	U1254	U1274	U1264
50	Yellow	U1255	U1275	U1265
60 •	Red	U1256	U1276	U1266
70	White	U1257	U1277	U1267
90	Orange	U1259	U1279	U1269

Complete box with one of above color codes.

To order rockers separately, use their P/N (U....) and complete box with code 0.

Rockers with illuminated windows (codes 20, 30, 60) : part numbers on request.

ROCKER MARKING



MARKING												
	-	01	02	06	07	08	03	04	05*	40	43*	46
COLOR												
Black	00	01	02	06	07	08	03	04	05*	40	43*	46
Red	00	11	12	16	17	18	13	14	15*	41	44*	47
White	00	21	22	26	27	28	23	24	25*	42	45*	48

* Not available on V-shaped rockers

Special markings and marking on rockers with illuminated window : consult factory.

2600 series

Power rocker switches

LAMP



- L0 Non-illuminated switch
- L6V Filament lamp 6 V
- L12V Filament lamp 12 V
- L24V Filament lamp 24 V
- L110V Neon lamp 110 VAC
- L110V1 BLUE fluorescent lamp 110 VAC
- L110V3 Green fluorescent lamp 110 VAC
- L220V Neon lamp 220 VAC
- L220V1 BLUE fluorescent lamp 220 VAC
- L220V3 Green fluorescent lamp 220 VAC
- L I EN61058-1 approved version without lamp (3 position switches)

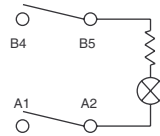

⚠ For illuminated models, the lamp is always connected between center terminals 2 and 5.

ILLUMINATED WINDOW

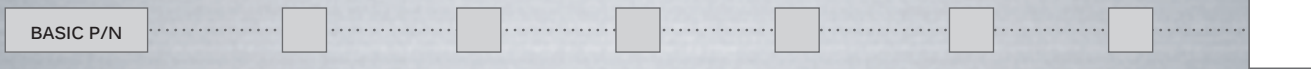

For black, green and red rockers only.

- /3 Green
- /6 Red

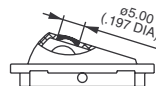

With green, use fluorescent lamp only.
No marking available on illuminated windows.