

## Data Sheet | Item Number: 231-646/019-000

1-conductor male connector; CAGE CLAMP®; 2.5 mm<sup>2</sup>; Pin spacing 5.08 mm; 16-pole; clamping collar; orange

<https://www.wago.com/231-646/019-000>



Color: ■ orange

Similar to illustration

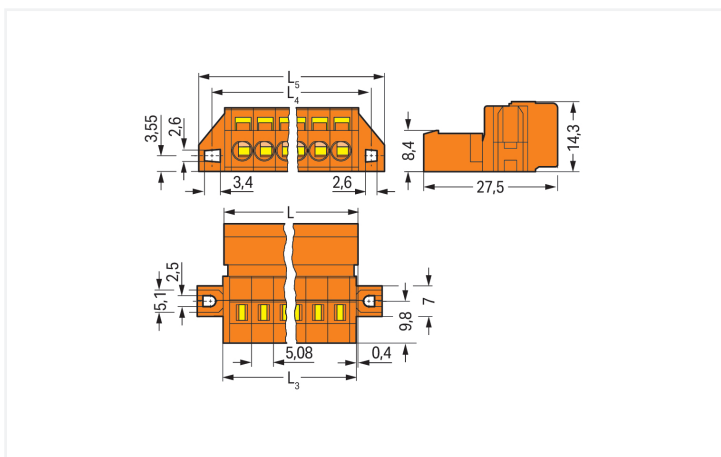
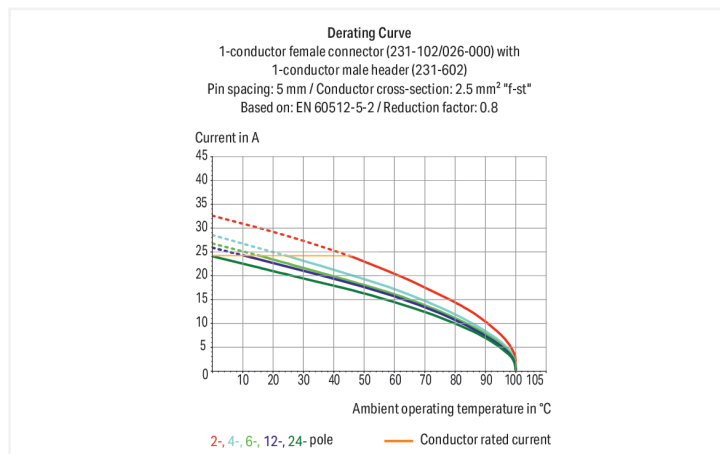

Dimensions in mm

$L = (\text{pole no.} - 1) \times \text{pin spacing} + 8.2 \text{ mm}$   
 $L_3 = L - 0.2 \text{ mm}$   
 $L_4 = L_3 + 5.8 \text{ mm}$   
 $L_5 = L_3 + 11.8 \text{ mm}$

Male connector, 231 Series, operating tool

This male connector (item number 231-646/019-000) is designed for hassle-free electrical installations. Ensure that the strip lengths are between 8 and 9 mm when connecting conductors to this male connector. This product features one conductor terminal and utilizes CAGE CLAMP®. Our highly-rated and maintenance-free CAGE CLAMP® connection makes it easy to connect all conductor types without having to prepare the conductor. For example, you don't need to crimp ferrules. Dimensions: (96.08 x 14.3 x 27.5) mm (width x height x depth). This male connector is suitable for conductor cross sections ranging from 0.08 mm<sup>2</sup> to 2.5 mm<sup>2</sup>. The contact surface is coated with tin.

## Notes

## Safety Information

The MCS – MULTI CONNECTION SYSTEM includes connectors without breaking capacity in accordance with DIN EN 61984. When used as intended, these connectors must not be connected/disconnected when live or under load. When used as intended, these connectors must not be connected/disconnected when live or under load. The circuit design should ensure header pins, which can be touched, are not live when unmated.

## Variants:

Other pole numbers  
Gold-plated or partially gold-plated contact surfaces  
Other versions (or variants) can be requested from WAGO Sales or configured at <https://configurator.wago.com/>.

## Electrical data

Ratings per	IEC/EN 60664-1		
Oversoltage category	III	III	II
Pollution degree	3	2	2
Nominal voltage	320 V	320 V	630 V
Rated impulse withstand voltage	4 kV	4 kV	4 kV
Rated current	12 A	12 A	12 A

Approvals per	UL 1059		
Use group	B	C	D
Rated voltage	300 V	-	300 V
Rated current	15 A	-	10 A

Approvals per	UL 1977
Rated voltage	600 V
Rated current	15 A

Approvals per	CSA		
Use group	B	C	D
Rated voltage	300 V	-	300 V
Rated current	15 A	-	10 A

## Connection Data

Clamping units	16
Total number of potentials	16
Number of connection types	1
Number of levels	1

Connection 1	
Connection technology	CAGE CLAMP®
Actuation type	Operating tool
Actuation direction 1	Operation parallel to conductor entry
Actuation direction 2	Operation perpendicular to conductor entry
Solid conductor	0.08 ... 2.5 mm <sup>2</sup> / 28 ... 12 AWG
Fine-stranded conductor	0.08 ... 2.5 mm <sup>2</sup> / 28 ... 12 AWG
Fine-stranded conductor; with insulated ferrule	0.25 ... 1.5 mm <sup>2</sup>
Fine-stranded conductor; with uninsulated ferrule	0.25 ... 2.5 mm <sup>2</sup>
Strip length	8 ... 9 mm / 0.31 ... 0.35 inches
Pole number	16
Conductor entry direction to mating direction	0°

## Physical data

Pin spacing	5.08 mm / 0.2 inches
Width	96.08 mm / 3.783 inches
Height	14.3 mm / 0.563 inches
Depth	27.5 mm / 1.083 inches

### Mechanical data

Variable coding	Yes
Mounting type	Mounting flange
Mounting type	Feed-through mounting Panel mounting
Anti-rotation protection	Yes
Suitable for through-panel applications	Yes

### Plug-in connection

Contact type (pluggable connector)	Male connector/plug
Connector (connection type)	for conductor
Mismating protection	No

### Material data

Note (material data)	<a href="#">Information on material specifications can be found here</a>
Color	orange
Material group	I
Insulation material (main housing)	Polyamide (PA66)
Flammability class per UL94	V0
Clamping spring material	Chrome-nickel spring steel (CrNi)
Contact material	Electrolytic copper (E <sub>Cu</sub> )
Contact Plating	Tin
Fire load	0.384 MJ
Weight	25.2 g

### Environmental requirements

Limit temperature range	-60 ... +100 °C	<b>Environmental Testing</b>
Processing temperature	-35 ... +60 °C	
		Test specification: DIN EN 50155 (VDE 0115-200):2022-06 Railway applications – Rolling stock – Electronic equipment
		Test procedure: DIN EN 61373 (VDE 0115-0106):2011-04 Railway applications – Rolling stock equipment – Vibration and shock tests
		Spectrum/Mounting location Service life test, Category 1, Class A/B
		Functional test with noise-like oscillations Test passed according to Section 8 of the standard
		Frequency $f_1 = 5 \text{ Hz}$ to $f_2 = 150 \text{ Hz}$
		Acceleration 0.101g (highest test level used for all axes)
		Test duration per axis 10 min.
		Test directions X, Y and Z axes
		Monitoring of contact faults and interruptions Passed
		Voltage drop measurement before and after each axis Passed
		Simulated service life test through increased levels of noise-like oscillations Test passed according to Section 9 of the standard
		Frequency $f_1 = 5 \text{ Hz}$ to $f_2 = 150 \text{ Hz}$
		Acceleration 0.572g (highest test level used for all axes)
		Test duration per axis 5 h
		Test directions X, Y and Z axes
		Extended testing: Monitoring of contact faults and interruptions Passed
		Extended testing: Voltage drop measurement before and after each axis Passed

**Environmental Testing**

Shock test	Test passed according to Section 10 of the standard
Shock pulse form	Half sine
Acceleration	5g (highest test level used for all axes)
Shock duration	30 ms
Number of shocks (per axis)	3 pos. und 3 neg.
Test directions	X, Y and Z axes
Extended testing: Monitoring of contact faults and interruptions	Passed
Extended testing: Voltage drop measurement before and after each axis	Passed
Vibration and shock stress for rolling stock equipment	Passed

**Commercial data**

Product Group	3 (Multi Conn. System)
PU (SPU)	10 pcs
Packaging type	Box
Country of origin	DE
GTIN	4044918260992
Customs tariff number	85366930000

**Product Classification**

UNSPSC	39121409
eCl@ss 10.0	27-44-03-09
eCl@ss 9.0	27-44-03-09
ETIM 9.0	EC002638
ETIM 10.0	EC002638
ECCN	NO US CLASSIFICATION

**Environmental Product Compliance**

RoHS Compliance Status	Compliant, No Exemption
------------------------	-------------------------

**Approvals / Certificates**

**General approvals**



Approval	Standard	Certificate Name
CB DEKRA Certification B.V.	IEC 61984	NL-113351
CSA DEKRA Certification B.V.	C22.2	1466354
KEMA/KEUR DEKRA Certification B.V.	EN 61984	71-130478 REV.1
UL UL International Germany GmbH	UL 1977	E45171
UR Underwriters Laboratories Inc.	UL 1059	E45172

**Declarations of conformity and manufacturer's declarations**



Approval	Standard	Certificate Name
Railway WAGO GmbH & Co. KG	-	Railway Ready

**Approvals for marine applications**



Approval	Standard	Certificate Name
ABS American Bureau of Ship- ping	-	24-0095975-PDA
BV Bureau Veritas S.A.	IEC 60998	11915/E0 BV
DNV DNV GL SE	-	TAE000016Z
PRS Polski Rejestr Statków	-	TE/1095/880590/23

**Downloads**

**Environmental Product Compliance**

Compliance Search
Environmental Product Compliance 231-646/019-000

**Documentation**

Additional Information
Technical Section 03.04.2019 pdf 2027.26 KB

**CAD/CAE-Data**

CAD data
2D/3D Models 231-646/019-000

CAE data
EPLAN Data Portal 231-646/019-000
ZUKEN Portal 231-646/019-000

**1 Compatible Products**

**1.1 System counterpart**

**1.1.1 Female connector/socket**



**Item No.: 231-316/026-000**  
1-conductor female connector; CAGE  
CLAMP®; 2.5 mm²; Pin spacing 5.08 mm; 16-  
pole; orange

**Item No.: 232-276**  
THT female header; angled; Pin spacing  
5.08 mm; 16-pole; 0.6 x 1.0 mm solder pin;  
orange

**Item No.: 232-176**  
THT female header; straight; Pin spacing  
5.08 mm; 16-pole; 0.6 x 1.0 mm solder pin;  
orange

## 1.2 Optional Accessories

### 1.2.1 Coding

#### 1.2.1.1 Coding



**Item No.: 231-129**

Coding key; snap-on type; light gray

### 1.2.2 Cover

#### 1.2.2.1 Cover



**Item No.: 231-669**

Lockout caps; for covering unused clamping units; orange

## 1.2.3 Ferrule

### 1.2.3.1 Ferrule



**Item No.: 216-301**

Ferrule; Sleeve for 0.25 mm<sup>2</sup> / AWG 24; insulated; electro-tin plated; yellow



**Item No.: 216-302**

Ferrule; Sleeve for 0.34 mm<sup>2</sup> / 22 AWG; insulated; electro-tin plated; light turquoise



**Item No.: 216-201**

Ferrule; Sleeve for 0.5 mm<sup>2</sup> / 20 AWG; insulated; electro-tin plated; electrolytic copper; acc. to DIN 46228, Part 4/09.90; white



**Item No.: 216-101**

Ferrule; Sleeve for 0.5 mm<sup>2</sup> / AWG 22; un-insulated; electro-tin plated; silver-colored



**Item No.: 216-202**

Ferrule; Sleeve for 0.75 mm<sup>2</sup> / 18 AWG; insulated; electro-tin plated; gray



**Item No.: 216-102**

Ferrule; Sleeve for 0.75 mm<sup>2</sup> / 18 AWG; un-insulated; electro-tin plated; silver-colored



**Item No.: 216-203**

Ferrule; Sleeve for 1 mm<sup>2</sup> / AWG 18; insulated; electro-tin plated; red



**Item No.: 216-103**

Ferrule; Sleeve for 1 mm<sup>2</sup> / AWG 18; un-insulated; electro-tin plated



**Item No.: 216-204**

Ferrule; Sleeve for 1.5 mm<sup>2</sup> / AWG 16; insulated; electro-tin plated; black



**Item No.: 216-104**

Ferrule; Sleeve for 1.5 mm<sup>2</sup> / AWG 16; un-insulated; electro-tin plated; silver-colored

## 1.2.4 Installation

### 1.2.4.1 Mounting accessories



**Item No.: 231-295**

Screw with nut



**Item No.: 231-195**

Screw with nut; M2x12; for fixing element



**Item No.: 209-147**

Self-tapping screw



**Item No.: 231-194**

Self-tapping screw; B 2.2x13, fixing hole 1.8 mm Ø

## 1.2.5 Insulation stop

### 1.2.5.1 Insulation stop



**Item No.: 231-670**

Insulation stop; 0.08-0.2 mm<sup>2</sup> / 0.2 mm<sup>2</sup> "s"; white



**Item No.: 231-671**

Insulation stop; 0.25 - 0.5 mm<sup>2</sup>; light gray



**Item No.: 231-672**

Insulation stop; 0.75 - 1 mm<sup>2</sup>; dark gray

## 1.2.6 Jumper

### 1.2.6.1 Jumper



**Item No.: 231-910**

Jumper; for conductor entry; 10-way; insulated; gray



**Item No.: 231-902**

Jumper; for conductor entry; 2-way; insulated; gray



**Item No.: 231-903**

Jumper; for conductor entry; 3-way; insulated; gray



**Item No.: 231-905**

Jumper; for conductor entry; 5-way; insulated; gray



**Item No.: 231-907**

Jumper; for conductor entry; 7-way; insulated; gray

## 1.2.7 Marking

### 1.2.7.1 Marking strip



**Item No.: 210-331/508-103**

Marking strips; as a DIN A4 sheet; MARKED; 1-12 (200x); Height of marker strip: 2.3 mm/0.091 in; Strip length 182 mm; Horizontal marking; Self-adhesive; white



**Item No.: 210-332/508-202**

Marking strips; as a DIN A4 sheet; MARKED; 1-16 (160x); Height of marker strip: 3 mm; Strip length 182 mm; Horizontal marking; Self-adhesive; white



**Item No.: 210-332/508-205**

Marking strips; as a DIN A4 sheet; MARKED; 1-32 (80x); Height of marker strip: 3 mm; Strip length 182 mm; Horizontal marking; Self-adhesive; white



**Item No.: 210-331/508-104**

Marking strips; as a DIN A4 sheet; MARKED; 13-24 (200x); Height of marker strip: 2.3 mm/0.091 in; Strip length 182 mm; Horizontal marking; Self-adhesive; white



**Item No.: 210-332/508-204**

Marking strips; as a DIN A4 sheet; MARKED; 17-32 (160x); Height of marker strip: 3 mm; Strip length 182 mm; Horizontal marking; Self-adhesive; white



**Item No.: 210-332/508-206**

Marking strips; as a DIN A4 sheet; MARKED; 33-48 (160x); Height of marker strip: 3 mm; Strip length 182 mm; Horizontal marking; Self-adhesive; white

## 1.2.8 Strain relief

### 1.2.8.1 Strain relief housing



**Item No.: 232-646**

Strain relief housing; for female and male connectors; 2 parts; Pin spacing 5.08 mm; 16-pole; orange

**1.2.9 Tool**

**1.2.9.1 Operating tool**



**Item No.: 210-720**

Operating tool; Blade: 3.5 x 0.5 mm; with a partially insulated shaft; multicoloured

**Item No.: 210-657**

Operating tool; Blade: 3.5 x 0.5 mm; with a partially insulated shaft; short; multi-coloured

**Item No.: 209-132**

Operating tool; for connecting comb-style jumper bar; made of insulating material; 2-way; natural

**Item No.: 280-440**

Operating tool; made of insulating material; 10-way; white



**Item No.: 209-130**

Operating tool; made of insulating material; 1-way; for 264 Series (1-/2-way), 280, 281 Series (up to 3-way); natural

**Item No.: 231-291**

Operating tool; made of insulating material; 1-way; loose; red

**Item No.: 231-131**

Operating tool; made of insulating material; 1-way; loose; white

**Item No.: 280-432**

Operating tool; made of insulating material; 2-way; white



**Item No.: 280-433**

Operating tool; made of insulating material; 3-way; white

**Item No.: 280-434**

Operating tool; made of insulating material; 4-way; white

**Item No.: 280-435**

Operating tool; made of insulating material; 5-way; gray

**Item No.: 280-436**

Operating tool; made of insulating material; 6-way; white



**Item No.: 280-437**

Operating tool; made of insulating material; 7-way; white

**Item No.: 280-438**

Operating tool; made of insulating material; 8-way; white

**Installation Notes**

**Conductor termination**

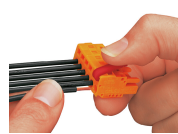
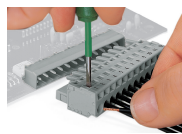
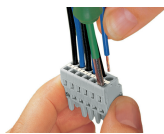

Inserting a conductor via 3.5 mm screwdriver – CAGE CLAMP® actuation parallel to conductor entry.

Inserting a conductor via 3.5 mm screwdriver – CAGE CLAMP® actuation perpendicular to conductor entry.

Inserting a conductor into CAGE CLAMP® unit via operating tool (231-291).

Inserting a conductor via operating tool.

**Coding**

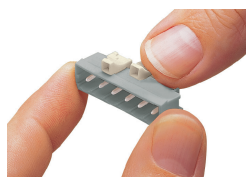

Coding a male header – fitting coding key(s).

**Testing**

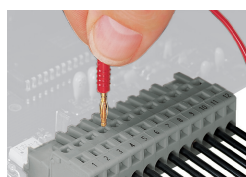

Testing – female connector with CAGE CLAMP®  
Integrated test ports for testing perpendicular to conductor entry via 2 or 2.3 mm Ø test plug

## Installation



Male connector with strain relief plate

Strain relief housing shown with a male connector equipped with CAGE CLAMP®

## Marking

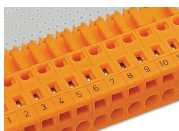

Labeling via direct marking or self-adhesive strips.