

FKC 2,5/ 3-ST - PCB connector



1910364

<https://www.phoenixcontact.com/us/products/1910364>

Please be informed that the data shown in this PDF document is generated from our online catalog. Please find the complete data in the user documentation. Our general terms of use for downloads are valid.

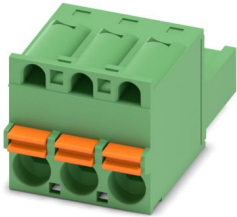

PCB connector, nominal cross section: 2.5 mm², color: green, nominal current: 12 A, rated voltage (III/2): 320 V, contact surface: Tin, contact connection type: Socket, number of potentials: 3, number of rows: 1, number of positions: 3, number of connections: 3, product range: FKC 2,5/.-ST, pitch: 5 mm, connection method: Push-in spring connection, conductor/PCB connection direction: 0 °, locking clip: - Locking clip, plug-in system: COMBICON MSTB 2,5, locking: without, mounting: without, type of packaging: packed in cardboard

Your advantages

- Time saving push-in connection, tools not required
- Intuitive operation due to color-coded actuating push button
- Quick and convenient testing using integrated test option
- Can be combined with the MSTB 2,5 range

Commercial data

Item number	1910364
Packing unit	100 pc
Minimum order quantity	100 pc
Sales key	AA03
Product key	AACFAC
Catalog page	Page 274 (C-1-2013)
GTIN	4017918175146
Weight per piece (including packing)	5.161 g
Weight per piece (excluding packing)	4.947 g
Customs tariff number	85366990
Country of origin	DE

FKC 2,5/ 3-ST - PCB connector



1910364

<https://www.phoenixcontact.com/us/products/1910364>

Technical data

Product properties

Product type	PCB connector
Product family	FKC 2,5/...-ST
Product line	COMBICON Connectors M
Type	Standard
Number of positions	3
Pitch	5 mm
Number of connections	3
Number of rows	1
Number of potentials	3
Mounting flange	without

Electrical properties

Nominal current I_N	12 A
Nominal voltage U_N	320 V
Contact resistance	1 m Ω
Rated voltage (III/3)	250 V
Rated surge voltage (III/3)	4 kV
Rated voltage (III/2)	320 V
Rated surge voltage (III/2)	4 kV
Rated voltage (II/2)	630 V
Rated surge voltage (II/2)	4 kV

Connection data

Connection technology

Type	Standard
Connector system	COMBICON MSTB 2,5
Nominal cross section	2.5 mm ²
Contact connection type	Socket

Interlock

Locking type	without
Mounting flange	without

Conductor connection

Connection method	Push-in spring connection
Conductor/PCB connection direction	0 °
Conductor cross section rigid	0.2 mm ² ... 2.5 mm ²
Conductor cross section flexible	0.2 mm ² ... 2.5 mm ²
Conductor cross section AWG	24 ... 12
Conductor cross section flexible, with ferrule without plastic sleeve	0.25 mm ² ... 2.5 mm ²

FKC 2,5/ 3-ST - PCB connector



1910364

<https://www.phoenixcontact.com/us/products/1910364>

Conductor cross section, flexible, with ferrule, with plastic sleeve	0.25 mm ² ... 2.5 mm ²
2 conductors with the same cross section, flexible, with TWIN ferrule with plastic sleeve	0.5 mm ² ... 1.5 mm ²
Cylindrical gauge a x b / diameter	2.8 mm x 2.0 mm / 2.0 mm
Stripping length	10 mm

Specifications for ferrules without insulating collar

recommended crimping tool	1212034 CRIMPFOX 6
ferrules without insulating collar, according to DIN 46228-1	Cross section: 0.5 mm ² ; Length: 8 mm ... 10 mm
	Cross section: 0.75 mm ² ; Length: 8 mm ... 10 mm
	Cross section: 1 mm ² ; Length: 8 mm ... 10 mm
	Cross section: 1.5 mm ² ; Length: 8 mm ... 10 mm
	Cross section: 2.5 mm ² ; Length: 10 mm

Specifications for ferrules with insulating collar

recommended crimping tool	1212034 CRIMPFOX 6
ferrules with insulating collar, according to DIN 46228-4	Cross section: 0.5 mm ² ; Length: 8 mm ... 10 mm
	Cross section: 0.75 mm ² ; Length: 8 mm ... 10 mm
	Cross section: 1 mm ² ; Length: 8 mm ... 10 mm
	Cross section: 1.5 mm ² ; Length: 8 mm ... 10 mm
	Cross section: 2.5 mm ² ; Length: 10 mm

Material specifications

Material data - contact

Note	WEEE/RoHS-compliant, free of whiskers according to IEC 60068-2-82/JEDEC JESD 201
Contact material	Cu alloy
Surface characteristics	hot-dip tin-plated
Metal surface terminal point (top layer)	Tin (4 - 8 µm Sn)
Metal surface contact area (top layer)	Tin (4 - 8 µm Sn)

Material data - housing

Color (Housing)	green (6021)
Insulating material	PA
Insulating material group	I
CTI according to IEC 60112	600
Flammability rating according to UL 94	V0
Glow wire flammability index GWFI according to EN 60695-2-12	850
Glow wire ignition temperature GWIT according to EN 60695-2-13	775
Temperature for the ball pressure test according to EN 60695-10-2	125 °C

Material data – actuating element

Color (Actuating element)	orange (2003)
Insulating material	PBT

FKC 2,5/ 3-ST - PCB connector



1910364

<https://www.phoenixcontact.com/us/products/1910364>

Insulating material group	I
CTI according to IEC 60112	600
Flammability rating according to UL 94	V0

Dimensions

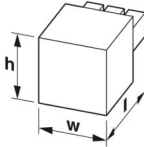
Dimensional drawing	
Pitch	5 mm
Width [w]	14.9 mm
Height [h]	15 mm
Length [l]	25.73 mm

Notes

Notes on operation	In accordance with IEC 61984, COMBICON connectors have no switching power (COC). During designated use, they must not be plugged in or disconnected when carrying voltage or under load.
--------------------	--

Mechanical tests

Conductor connection

Specification	IEC 60999-1:1999-11
Result	Test passed

Test for conductor damage and slackening

Specification	IEC 60999-1:1999-11
Result	Test passed

Repeated connection and disconnection

Specification	IEC 60999-1:1999-11
Result	Test passed

Pull-out test

Specification	IEC 60999-1:1999-11
Conductor cross section/conductor type/tractive force setpoint/actual value	0.2 mm ² / solid / > 10 N
	0.2 mm ² / flexible / > 10 N
	2.5 mm ² / solid / > 50 N
	2.5 mm ² / flexible / > 50 N

Insertion and withdrawal forces

Result	Test passed
No. of cycles	25
Insertion strength per pos. approx.	8 N
Withdraw strength per pos. approx.	6 N

FKC 2,5/ 3-ST - PCB connector



1910364

<https://www.phoenixcontact.com/us/products/1910364>

Resistance of inscriptions

Specification	IEC 60068-2-70:1995-12
Result	Test passed

Polarization and coding

Specification	IEC 60512-13-5:2006-02
Result	Test passed

Visual inspection

Specification	IEC 60512-1-1:2002-02
Result	Test passed

Dimension check

Specification	IEC 60512-1-2:2002-02
Result	Test passed

Environmental and real-life conditions

Vibration test

Specification	IEC 60068-2-6:2007-12
Frequency	10 - 150 - 10 Hz
Sweep speed	1 octave/min
Amplitude	0.35 mm (10 Hz ... 60.1 Hz)
Acceleration	5g (60.1 Hz ... 150 Hz)
Test duration per axis	2.5 h
Test directions	X-, Y- and Z-axis

Durability test

Specification	IEC 60512-9-1:2010-03
Impulse withstand voltage at sea level	4.8 kV
Contact resistance R_1	1 m Ω
Contact resistance R_2	1.2 m Ω
Insertion/withdrawal cycles	25
Insulation resistance, neighboring positions	> 5 M Ω

Climatic test

Specification	ISO 6988:1985-02
Corrosive stress	0.2 dm ³ SO ₂ on 300 dm ³ /40 °C/1 cycle
Thermal stress	100 °C/168 h
Power-frequency withstand voltage	2.21 kV

Ambient conditions

Ambient temperature (operation)	-40 °C ... 100 °C (dependent on the derating curve)
Ambient temperature (storage/transport)	-40 °C ... 70 °C
Relative humidity (storage/transport)	30 % ... 70 %
Ambient temperature (assembly)	-5 °C ... 100 °C

FKC 2,5/ 3-ST - PCB connector



1910364

<https://www.phoenixcontact.com/us/products/1910364>

Electrical tests

Thermal test | Test group C

Specification	IEC 60512-5-1:2002-02
Tested number of positions	18

Insulation resistance

Specification	IEC 60512-3-1:2002-02
Insulation resistance, neighboring positions	> 5 MΩ

Air clearances and creepage distances |

Specification	IEC 60664-1:2007-04
Insulating material group	I
Comparative tracking index (IEC 60112)	CTI 600
Rated insulation voltage (III/3)	250 V
Rated surge voltage (III/3)	4 kV
minimum clearance value - non-homogenous field (III/3)	3 mm
minimum creepage distance (III/3)	3.2 mm
Rated insulation voltage (III/2)	320 V
Rated surge voltage (III/2)	4 kV
minimum clearance value - non-homogenous field (III/2)	3 mm
minimum creepage distance (III/2)	3 mm
Rated insulation voltage (II/2)	630 V
Rated surge voltage (II/2)	4 kV
minimum clearance value - non-homogenous field (II/2)	3 mm
minimum creepage distance (II/2)	3.2 mm

Packaging specifications

Type of packaging	packed in cardboard
-------------------	---------------------

FKC 2,5/ 3-ST - PCB connector



1910364

<https://www.phoenixcontact.com/us/products/1910364>

Drawings

Diagram



Type: FKC 2,5/...-ST with SMSTB 2,5/...-G

FKC 2,5/ 3-ST - PCB connector





1910364

<https://www.phoenixcontact.com/us/products/1910364>

Approvals

To download certificates, visit the product detail page: <https://www.phoenixcontact.com/us/products/1910364>

 CSA Approval ID: 13631				
	Nominal voltage U_N	Nominal current I_N	Cross section AWG	Cross section mm^2
Use group B				
	300 V	12 A	24 - 12	-
Use group D				
	300 V	10 A	24 - 12	-

 cULus Recognized Approval ID: E60425-19931011				
	Nominal voltage U_N	Nominal current I_N	Cross section AWG	Cross section mm^2
Use group B				
	300 V	10 A	26 - 12	-
Use group D				
	300 V	10 A	26 - 12	-

 VDE Zeichengenehmigung Approval ID: 40004701				
	Nominal voltage U_N	Nominal current I_N	Cross section AWG	Cross section mm^2
	250 V	12 A	-	0.2 - 2.5

FKC 2,5/ 3-ST - PCB connector



1910364

<https://www.phoenixcontact.com/us/products/1910364>

Classifications

ECLASS

ECLASS-11.0	27460202
ECLASS-12.0	27460202
ECLASS-13.0	27460202

ETIM

ETIM 9.0	EC002638
----------	----------

UNSPSC

UNSPSC 21.0	39121400
-------------	----------

FKC 2,5/ 3-ST - PCB connector



1910364

<https://www.phoenixcontact.com/us/products/1910364>

Environmental product compliance

EU RoHS

Fulfills EU RoHS substance requirements	Yes, No exemptions
---	--------------------

China RoHS

Environment friendly use period (EFUP)	EFUP-E
	No hazardous substances above the limits

EU REACH SVHC

REACH candidate substance (CAS No.)	No substance above 0.1 wt%
-------------------------------------	----------------------------

FKC 2,5/ 3-ST - PCB connector



1910364

<https://www.phoenixcontact.com/us/products/1910364>

Accessories

CP-MSTB - Coding profile

1734634

<https://www.phoenixcontact.com/us/products/1734634>

Coding profile, is inserted into the slot on the plug or inverted header, red insulating material



STZ 4-FKC-5,08 - Strain relief

1876877

<https://www.phoenixcontact.com/us/products/1876877>

Strain relief for snapping into the latching chambers of the plugs, 4-pos.



FKC 2,5/ 3-ST - PCB connector

1910364

<https://www.phoenixcontact.com/us/products/1910364>



STZ 8-FKC-5,08 - Strain relief

1876880

<https://www.phoenixcontact.com/us/products/1876880>



Strain relief for snapping into the latching chambers of the plug components, 8-pos.

MPS-MT - Test plug

0201744

<https://www.phoenixcontact.com/us/products/0201744>



Test plug, with solder connection up to 1 mm² conductor cross section, number of positions: 1, color: gray

FKC 2,5/ 3-ST - PCB connector

1910364

<https://www.phoenixcontact.com/us/products/1910364>



RPS - Reducing plug

0201647

<https://www.phoenixcontact.com/us/products/0201647>



Reducing plug, number of positions: 1, color: gray

SZS 0,6X3,5 - Screwdriver

1205053

<https://www.phoenixcontact.com/us/products/1205053>



Actuation tool, for ST terminal blocks, insulated, also suitable for use as a bladed screwdriver, size: 0.6 x 3.5 x 100 mm, 2-component grip, with non-slip grip

FKC 2,5/ 3-ST - PCB connector

1910364

<https://www.phoenixcontact.com/us/products/1910364>



SK 5/3,8:FORTL.ZAHLEN - Marker card

0804183

<https://www.phoenixcontact.com/us/products/0804183>

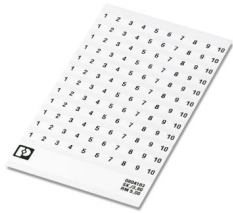

Marker card, white, labeled, horizontal: consecutive numbers 1 ... 10, 11 ... 20, etc. up to 91 ... (99)100, mounting type: adhesive, for terminal block width: 5 mm, lettering field size: 5 x 3.8 mm

MSTBW 2,5/ 3-G - PCB header

1736108

<https://www.phoenixcontact.com/us/products/1736108>

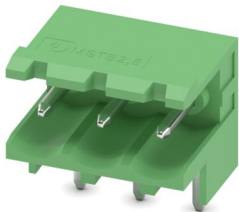

PCB headers, nominal cross section: 2.5 mm², color: green, nominal current: 12 A, rated voltage (III/2): 320 V, contact surface: Tin, contact connection type: Pin, number of potentials: 3, number of rows: 1, number of positions: 3, number of connections: 3, product range: MSTBW 2,5/..-G, pitch: 5 mm, mounting: Wave soldering, pin layout: Linear pinning, solder pin [P]: 3.5 mm, number of solder pins per potential: 1, plug-in system: COMBICON MSTB 2,5, Pin connector pattern alignment: Standard, locking: without, mounting: without, type of packaging: packed in cardboard

FKC 2,5/ 3-ST - PCB connector

1910364

<https://www.phoenixcontact.com/us/products/1910364>

MDSTB 2,5/ 3-G1 - PCB header

1736687

<https://www.phoenixcontact.com/us/products/1736687>

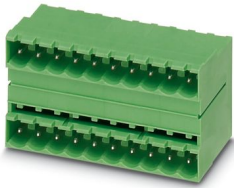

PCB headers, nominal cross section: 2.5 mm², color: green, nominal current: 10 A, rated voltage (III/2): 320 V, contact surface: Tin, contact connection type: Pin, number of potentials: 6, number of rows: 2, number of positions: 3, number of connections: 6, product range: MDSTB 2,5/..-G1, pitch: 5 mm, mounting: Wave soldering, pin layout: Linear pinning, solder pin [P]: 3.3 mm, number of solder pins per potential: 1, plug-in system: COMBICON MSTB 2,5, Pin connector pattern alignment: Standard, locking: without, mounting: without, type of packaging: packed in cardboard, In combination with MVSTB or FKCV plug components, both an MVSTBW (or FKCVW) and an MVSTBR plug (or FKCVR) must be used. Combination with TMSTBP plug components is not possible!

MDSTBV 2,5/ 3-G1 - PCB header

1736726

<https://www.phoenixcontact.com/us/products/1736726>

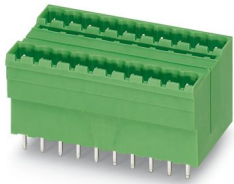

PCB headers, nominal cross section: 2.5 mm², color: green, nominal current: 10 A, rated voltage (III/2): 320 V, contact surface: Tin, contact connection type: Pin, number of potentials: 6, number of rows: 2, number of positions: 3, number of connections: 6, product range: MDSTBV 2,5/..-G1, pitch: 5 mm, mounting: Wave soldering, pin layout: Linear pinning, solder pin [P]: 3.9 mm, number of solder pins per potential: 1, plug-in system: COMBICON MSTB 2,5, Pin connector pattern alignment: Standard, locking: without, mounting: without, type of packaging: packed in cardboard, In combination with MVSTB or FKCV plug components, both an MVSTBW (or FKCVW) and an MVSTBR plug (or FKCVR) must be used. Combination with TMSTBP plug components is not possible!

FKC 2,5/ 3-ST - PCB connector

1910364

<https://www.phoenixcontact.com/us/products/1910364>



MSTBV 2,5/ 3-G - PCB header

1753453

<https://www.phoenixcontact.com/us/products/1753453>

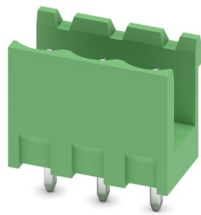

PCB headers, nominal cross section: 2.5 mm², color: green, nominal current: 12 A, rated voltage (III/2): 320 V, contact surface: Tin, contact connection type: Pin, number of potentials: 3, number of rows: 1, number of positions: 3, number of connections: 3, product range: MSTBV 2,5/..-G, pitch: 5 mm, mounting: Wave soldering, pin layout: Linear pinning, solder pin [P]: 3.9 mm, number of solder pins per potential: 1, plug-in system: COMBICON MSTB 2,5, Pin connector pattern alignment: Standard, locking: without, mounting: without, type of packaging: packed in cardboard

MSTB 2,5/ 3-G - PCB header

1754452

<https://www.phoenixcontact.com/us/products/1754452>

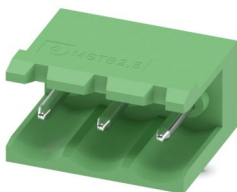

PCB headers, nominal cross section: 2.5 mm², color: green, nominal current: 12 A, rated voltage (III/2): 320 V, contact surface: Tin, contact connection type: Pin, number of potentials: 3, number of rows: 1, number of positions: 3, number of connections: 3, product range: MSTB 2,5/..-G, pitch: 5 mm, mounting: Wave soldering, pin layout: Linear pinning, solder pin [P]: 3.23 mm, number of solder pins per potential: 1, plug-in system: COMBICON MSTB 2,5, Pin connector pattern alignment: Standard, locking: without, mounting: without, type of packaging: packed in cardboard

FKC 2,5/ 3-ST - PCB connector

1910364

<https://www.phoenixcontact.com/us/products/1910364>



MSTBVA 2,5/ 3-G - PCB header

1755529

<https://www.phoenixcontact.com/us/products/1755529>

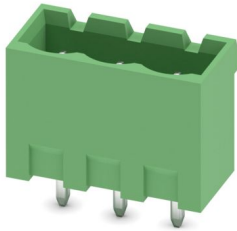

PCB headers, nominal cross section: 2.5 mm², color: green, nominal current: 12 A, rated voltage (III/2): 320 V, contact surface: Tin, contact connection type: Pin, number of potentials: 3, number of rows: 1, number of positions: 3, number of connections: 3, product range: MSTBVA 2,5/..-G, pitch: 5 mm, mounting: Wave soldering, pin layout: Linear pinning, solder pin [P]: 3.9 mm, number of solder pins per potential: 1, plug-in system: COMBICON MSTB 2,5, Pin connector pattern alignment: Standard, locking: without, mounting: without, type of packaging: packed in cardboard

MSTBA 2,5/ 3-G - PCB header

1757488

<https://www.phoenixcontact.com/us/products/1757488>

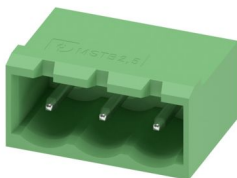

PCB headers, nominal cross section: 2.5 mm², color: green, nominal current: 12 A, rated voltage (III/2): 320 V, contact surface: Tin, contact connection type: Pin, number of potentials: 3, number of rows: 1, number of positions: 3, number of connections: 3, product range: MSTBA 2,5/..-G, pitch: 5 mm, mounting: Wave soldering, pin layout: Linear pinning, solder pin [P]: 3.23 mm, number of solder pins per potential: 1, plug-in system: COMBICON MSTB 2,5, Pin connector pattern alignment: Standard, locking: without, mounting: without, type of packaging: packed in cardboard

FKC 2,5/ 3-ST - PCB connector

1910364

<https://www.phoenixcontact.com/us/products/1910364>



MDSTB 2,5/ 3-G - PCB header

1762059

<https://www.phoenixcontact.com/us/products/1762059>

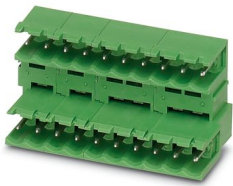

PCB headers, nominal cross section: 2.5 mm², color: green, nominal current: 10 A, rated voltage (III/2): 320 V, contact surface: Tin, contact connection type: Pin, number of potentials: 6, number of rows: 2, number of positions: 3, number of connections: 6, product range: MDSTB 2,5/..-G, pitch: 5 mm, mounting: Wave soldering, pin layout: Linear pinning, solder pin [P]: 3.23 mm, number of solder pins per potential: 1, plug-in system: COMBICON MSTB 2,5, Pin connector pattern alignment: Standard, locking: without, mounting: without, type of packaging: packed in cardboard, Can be aligned! Mounting flange: Item No. 1736771, 1736768. In combination with MVSTB or FKCV plugs, both an MVSTBW (or FKCVW) and an MVSTBR plug (or FKCVR) must be used. Combination with TMSTBP plugs is not possible!

MDSTBV 2,5/ 3-G - PCB header

1763045

<https://www.phoenixcontact.com/us/products/1763045>

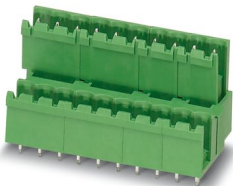

PCB headers, nominal cross section: 2.5 mm², color: green, nominal current: 10 A, rated voltage (III/2): 320 V, contact surface: Tin, contact connection type: Pin, number of potentials: 6, number of rows: 2, number of positions: 3, number of connections: 6, product range: MDSTBV 2,5/..-G, pitch: 5 mm, mounting: Wave soldering, pin layout: Linear pinning, solder pin [P]: 3.9 mm, number of solder pins per potential: 1, plug-in system: COMBICON MSTB 2,5, Pin connector pattern alignment: Standard, locking: without, mounting: without, type of packaging: packed in cardboard, Can be aligned! Mounting flange: Item No. 1836477, 1836480. In combination with MVSTB or FKCV plug components, both an MVSTBW (or FKCVW) and an MVSTBR plug (or FKCVR) must be used. Combination with TMSTBP plug components is not possible!

FKC 2,5/ 3-ST - PCB connector

1910364

<https://www.phoenixcontact.com/us/products/1910364>



SMSTBA 2,5/ 3-G - PCB header

1769816

<https://www.phoenixcontact.com/us/products/1769816>



PCB headers, nominal cross section: 2.5 mm², color: green, nominal current: 12 A, rated voltage (III/2): 320 V, contact surface: Tin, contact connection type: Pin, number of potentials: 3, number of rows: 1, number of positions: 3, number of connections: 3, product range: SMSTBA 2,5/...-G, pitch: 5 mm, mounting: Wave soldering, pin layout: Linear pinning, solder pin [P]: 3.5 mm, number of solder pins per potential: 1, plug-in system: COMBICON MSTB 2,5, Pin connector pattern alignment: Standard, locking: without, mounting: without, type of packaging: packed in cardboard

MDSTBVA 2,5/ 3-G - PCB header

1845798

<https://www.phoenixcontact.com/us/products/1845798>

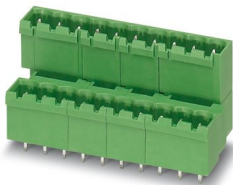

PCB headers, nominal cross section: 2.5 mm², color: green, nominal current: 10 A, rated voltage (III/2): 320 V, contact surface: Tin, contact connection type: Pin, number of potentials: 6, number of rows: 2, number of positions: 3, number of connections: 6, product range: MDSTBVA 2,5/...-G, pitch: 5 mm, mounting: Wave soldering, pin layout: Linear pinning, solder pin [P]: 3.9 mm, number of solder pins per potential: 1, plug-in system: COMBICON MSTB 2,5, Pin connector pattern alignment: Standard, locking: without, mounting: without, type of packaging: packed in cardboard, The article can be aligned to create different nos. of positions! In combination with MVSTB or FKCV plug components, both an MVSTBW (or FKCVW) and an MVSTBR plug (or FKCVR) must be used. Combination with TMSTBP plug components is not possible!

FKC 2,5/ 3-ST - PCB connector

1910364

<https://www.phoenixcontact.com/us/products/1910364>



MDSTBA 2,5/ 3-G - PCB header

1846522

<https://www.phoenixcontact.com/us/products/1846522>

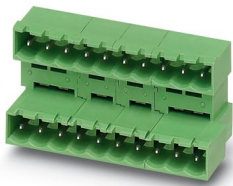

PCB headers, nominal cross section: 2.5 mm², color: green, nominal current: 10 A, rated voltage (III/2): 320 V, contact surface: Tin, contact connection type: Pin, number of potentials: 6, number of rows: 2, number of positions: 3, number of connections: 6, product range: MDSTBA 2,5/...-G, pitch: 5 mm, mounting: Wave soldering, pin layout: Linear pinning, solder pin [P]: 3.23 mm, number of solder pins per potential: 1, plug-in system: COMBICON MSTB 2,5, Pin connector pattern alignment: Standard, locking: without, mounting: without, type of packaging: packed in cardboard, The article can be aligned to create different nos. of positions! In combination with MVSTB or FKCV plug components, both an MVSTBW (or FKCVW) and an MVSTBR plug (or FKCVR) must be used. Combination with TMSTBP plug components is not possible!

MSTBO 2,5/ 3-G1L - PCB header

1861028

<https://www.phoenixcontact.com/us/products/1861028>



PCB headers, nominal cross section: 2.5 mm², color: green, nominal current: 12 A, rated voltage (III/2): 320 V, contact surface: Tin, contact connection type: Pin, number of rows: 1, number of positions: 3, product range: MSTBO 2,5/...-G1L, pitch: 5 mm, mounting: Wave soldering, pin layout: Linear pinning, solder pin [P]: 3.5 mm, number of solder pins per potential: 1, plug-in system: COMBICON MSTB 2,5, locking: without, type of packaging: packed in cardboard, Product with pin output on left side

FKC 2,5/ 3-ST - PCB connector

1910364

<https://www.phoenixcontact.com/us/products/1910364>



MSTBO 2,5/ 3-G1R - PCB header

1861031

<https://www.phoenixcontact.com/us/products/1861031>



PCB headers, nominal cross section: 2.5 mm², color: green, nominal current: 12 A, rated voltage (III/2): 320 V, contact surface: Tin, contact connection type: Pin, number of potentials: 3, number of rows: 1, number of positions: 3, number of connections: 3, product range: MSTBO 2,5/..-G1R, pitch: 5 mm, connection method: pluggable, mounting: Wave soldering, pin layout: Linear pinning, solder pin [P]: 3.5 mm, number of solder pins per potential: 1, plug-in system: COMBICON MSTB 2,5, locking: without, type of packaging: packed in cardboard, Product with pin output on right side

MDSTBA 2,5/ 3-GL - PCB header

1874691

<https://www.phoenixcontact.com/us/products/1874691>

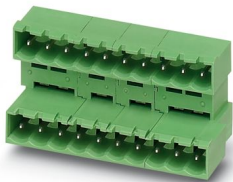

PCB headers, nominal cross section: 2.5 mm², color: green, nominal current: 10 A, rated voltage (III/2): 320 V, contact surface: Tin, contact connection type: Pin, number of potentials: 6, number of rows: 2, number of positions: 3, number of connections: 6, product range: MDSTBA 2,5/..-G, pitch: 5 mm, mounting: Wave soldering, pin layout: Linear pinning, solder pin [P]: 3.23 mm, number of solder pins per potential: 1, plug-in system: COMBICON MSTB 2,5, Pin connector pattern alignment: Standard, locking: without, mounting: without, type of packaging: packed in cardboard, The article can be aligned to create different nos. of positions! In combination with MVSTB or FKCV plug components, both an MVSTBW (or FKCVW) and an MVSTBR plug (or FKCVR) must be used. Combination with TMSTBP plug components is not possible!

FKC 2,5/ 3-ST - PCB connector

1910364

<https://www.phoenixcontact.com/us/products/1910364>



MDSTBA 2,5/ 3-GR - PCB header

1874701

<https://www.phoenixcontact.com/us/products/1874701>

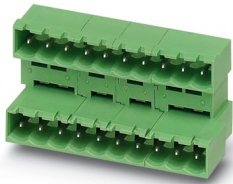

PCB headers, nominal cross section: 2.5 mm², color: green, nominal current: 10 A, rated voltage (III/2): 320 V, contact surface: Tin, contact connection type: Pin, number of potentials: 6, number of rows: 2, number of positions: 3, number of connections: 6, product range: MDSTBA 2,5/..-G, pitch: 5 mm, mounting: Wave soldering, pin layout: Linear pinning, solder pin [P]: 3.23 mm, number of solder pins per potential: 1, plug-in system: COMBICON MSTB 2,5, Pin connector pattern alignment: Standard, locking: without, mounting: without, type of packaging: packed in cardboard, The article can be aligned to create different nos. of positions! In combination with MVSTB or FKCV plug components, both an MVSTBW (or FKCVW) and an MVSTBR plug (or FKCVR) must be used. Combination with TMSTBP plug components is not possible!

MSTBO 2,5/ 3 G1L THRR44 BK - PCB header

2915216

<https://www.phoenixcontact.com/us/products/2915216>



PCB headers, nominal cross section: 2.5 mm², color: black, nominal current: 16 A, rated voltage (III/2): 320 V, contact surface: Tin, contact connection type: Pin, number of rows: 1, number of positions: 3, product range: MSTBO 2,5/..-G1L-THR, pitch: 5 mm, mounting: THR soldering, pin layout: Linear pinning, solder pin [P]: 2.5 mm, number of solder pins per potential: 1, plug-in system: COMBICON MSTB 2,5, locking: without, type of packaging: 44 mm wide tape, Article with lateral pin exit

FKC 2,5/ 3-ST - PCB connector

1910364

<https://www.phoenixcontact.com/us/products/1910364>



MSTBO 2,5/ 3 G1R THRR44 BK - PCB header

2915229

<https://www.phoenixcontact.com/us/products/2915229>



PCB headers, nominal cross section: 2.5 mm², color: black, nominal current: 16 A, rated voltage (III/2): 320 V, contact surface: Tin, contact connection type: Pin, number of rows: 1, number of positions: 3, product range: MSTBO 2,5/..-G1R-THR, pitch: 5 mm, mounting: THR soldering, pin layout: Linear pinning, solder pin [P]: 2.5 mm, number of solder pins per potential: 1, plug-in system: COMBICON MSTB 2,5, locking: without, type of packaging: 44 mm wide tape, Article with lateral pin exit

Phoenix Contact 2024 © - all rights reserved

<https://www.phoenixcontact.com>

Phoenix Contact USA
586 Fulling Mill Road
Middletown, PA 17057, United States
(+717) 944-1300
info@phoenixcon.com