

Data Sheet | Item Number: 831-1103/302-004

1-conductor female connector; lever; Push-in CAGE CLAMP®; 10 mm²; Pin spacing 7.62 mm; 3-pole; 100% protected against mismatching; Centered locking levers; 10,00 mm²; black

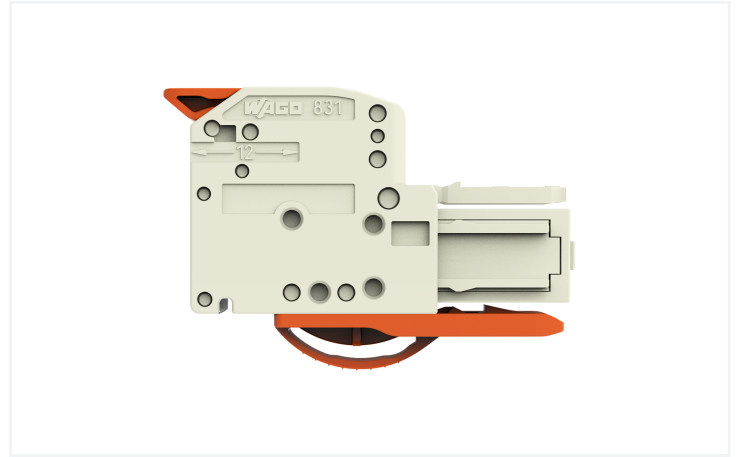

<https://www.wago.com/831-1103/302-004>

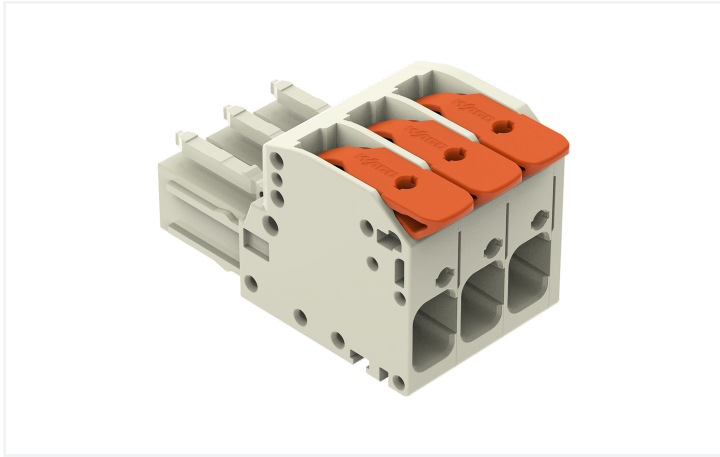

Color: ■ black

Similar to illustration

Similar to illustration



Similar to illustration

Similar to illustration

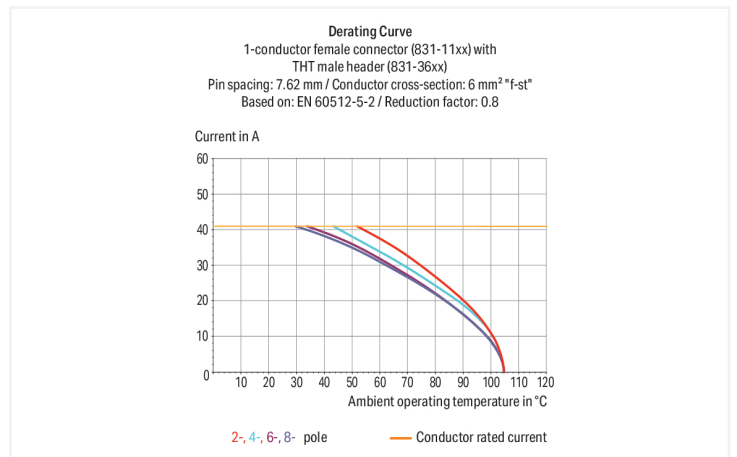
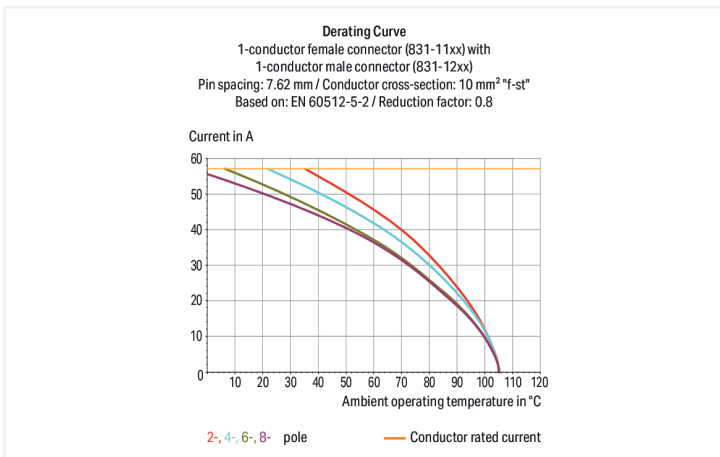

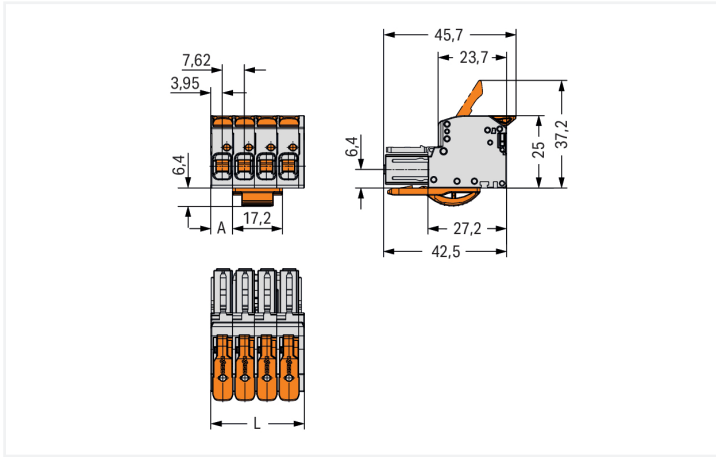

Dimensions in mm

L = pole no. x pin spacing + 1.9 mm
 Pole no. 2: A = 0.1 mm
 Pole no. 3: A = 7.5 mm
 Pole no. 4: A = 7.5 mm
 Pole no. 5: A = 15.12 mm
 Pole no. 6: A = 15.12 mm
 Pole no. 7: A = 22.74 mm
 Pole no. 8: A = 22.74 mm
 Pole no. 9: A = 30.36 mm

Female connector, 831 Series, Push-in CAGE CLAMP®

This female connector (item number 831-1103/302-004) simplifies electrical installations. Ensure that the strip lengths are between 11 and 13 mm when connecting conductors to this female connector. This product features one conductor terminal and utilizes Push-in CAGE CLAMP®. Push-in CAGE CLAMP® technology provides a universal connection solution for any type of conductor. It allows both solid and fine-stranded conductors with ferrules to be inserted directly into the clamping point without the need for tools. The item's dimensions are (24.7 x 31.4 x 45.7) mm (width x height x depth). Depending on the type of conductor, this female connector is suitable for conductor cross sections ranging from 0.5 mm² to 10 mm².

Tin is used for coating the contact surfaces.

Notes

Safety Information
 The MCS – MULTI CONNECTION SYSTEM includes connectors without breaking capacity in accordance with DIN EN 61984. When used as intended, these connectors must not be connected/disconnected when live or under load. When used as intended, these connectors must not be connected/disconnected when live or under load. The circuit design should ensure header pins, which can be touched, are not live when unmated.

Variants:
 Other colors
 Other versions (or variants) can be requested from WAGO Sales or configured at <https://configurator.wago.com/>.

Electrical data

Ratings per IEC/EN		Ratings per UL	
Ratings per	IEC/EN 60664-1	Approvals per	UL 1059
Nominal voltage (III/3)	800 V	Rated voltage UL (Use Group C)	600 V
Rated impulse withstand voltage (III / 3)	8 kV	Rated current UL (Use Group C)	37 A
Rated voltage (III/2)	1000 V	Rated voltage UL (Use Group D)	600 V
Rated impulse withstand voltage (III/2)	8 kV	Rated current UL (Use Group D)	5 A
Nominal voltage (II/2)	1000 V		
Rated impulse withstand voltage (II/2)	8 kV		
Rated current	41 A		
Legend (ratings)	(III / 2) ≙ Overvoltage category III / Pollution degree 2		

Ratings per CSA

Approvals per	CSA
Rated voltage CSA (Use Group C)	600 V
Rated current CSA (Use Group C)	35 A
Rated voltage CSA (Use Group D)	600 V
Rated current CSA (Use Group D)	5 A

Connection Data

Clamping units	3
Total number of potentials	3
Number of connection types	1
Number of levels	1

Connection 1

Connection technology	Push-in CAGE CLAMP®
Actuation type	Lever
Solid conductor	0.5 ... 10 mm ² / 20 ... 8 AWG
Fine-stranded conductor	0.5 ... 10 mm ² / 20 ... 8 AWG
Fine-stranded conductor; with insulated ferrule	0.5 ... 6 mm ²
Fine-stranded conductor; with uninsulated ferrule	0.5 ... 6 mm ²
Strip length	11 ... 13 mm / 0.43 ... 0.51 inches
Pole number	3
Conductor entry direction to mating direction	0°

Physical data

Pin spacing	7.62 mm / 0.3 inches
Width	24.7 mm / 0.975 inches
Height	31.4 mm / 1.236 inches
Depth	45.7 mm / 1.799 inches

Mechanical data

Variable coding	Yes
Anti-rotation protection	Yes

Plug-in connection

Contact type (pluggable connector)	Female connector/socket
Connector (connection type)	for conductor
Mismating protection	Yes
Locking of plug-in connection	Center locking lever

Material data

Note (material data)	Information on material specifications can be found here
Color	black
Material group	I
Insulation material (main housing)	Polyamide (PA66)
Flammability class per UL94	V0
Clamping spring material	Chrome-nickel spring steel (CrNi)
Contact material	Electrolytic copper (E _{Cu})
Contact Plating	Tin
Fire load	0.356 MJ
Actuator color	orange
Weight	22.1 g

Environmental requirements

Limit temperature range	-60 ... +105 °C
Processing temperature	-35 ... +60 °C

Commercial data

PU (SPU)	24 pcs
Packaging type	Box
Country of origin	PL
GTIN	4066966415421
Customs tariff number	85366990990

Product Classification

UNSPSC	39121409
ETIM 9.0	EC001284
ETIM 10.0	EC001284
ECCN	NO US CLASSIFICATION

Environmental Product Compliance

RoHS Compliance Status	Compliant, No Exemption
------------------------	-------------------------

Approvals / Certificates

General approvals



Approval	Standard	Certificate Name
UL Underwriters Laboratories Inc.	UL 1059	UL-US-2426356-0

Downloads

Environmental Product Compliance

Compliance Search	
Environmental Product Compliance 831-1103/302-004	↓

Documentation

Additional Information

Technical Section	03.04.2019	pdf 2027.26 KB	
-------------------	------------	-------------------	--

1 Compatible Products

1.1 System counterpart

1.1.1 Male connector/plug



Item No.: 831-1203

1-conductor male connector; lever; Push-in CAGE CLAMP®; 10 mm²; Pin spacing 7.62 mm; 3-pole; 100% protected against mismatching; 10,00 mm²; light gray



Item No.: 831-3623

THT male header; 1.0 x 1.2 mm solder pin; angled; 100% protected against mismatching; Pin spacing 7.62 mm; 3-pole; light gray



Item No.: 831-3643

THT male header; 1.0 x 1.2 mm solder pin; angled; 100% protected against mismatching; Pin spacing 7.62 mm; 3-pole; light gray



Item No.: 831-3603

THT male header; 1.0 x 1.2 mm solder pin; straight; 100% protected against mismatching; Pin spacing 7.62 mm; 3-pole; light gray

1.2 Optional Accessories

1.2.1 Ferrule

1.2.1.1 Ferrule



Item No.: 216-262

Ferrule; Sleeve for 0.75 mm² / 18 AWG; insulated; electro-tin plated; electrolytic copper; gastight crimped; acc. to DIN 46228, Part 4/09.90; gray



Item No.: 216-263

Ferrule; Sleeve for 1 mm² / AWG 18; insulated; electro-tin plated; electrolytic copper; gastight crimped; acc. to DIN 46228, Part 4/09.90; red



Item No.: 216-264

Ferrule; Sleeve for 1.5 mm² / AWG 16; insulated; electro-tin plated; electrolytic copper; gastight crimped; acc. to DIN 46228, Part 4/09.90; black



Item No.: 216-266

Ferrule; Sleeve for 2.5 mm² / AWG 14; insulated; electro-tin plated; electrolytic copper; gastight crimped; acc. to DIN 46228, Part 4/09.90; blue



Item No.: 216-267

Ferrule; Sleeve for 4 mm² / AWG 12; insulated; electro-tin plated; electrolytic copper; gastight crimped; acc. to DIN 46228, Part 4/09.90; gray



Item No.: 216-208

Ferrule; Sleeve for 6 mm² / AWG 10; insulated; electro-tin plated; electrolytic copper; gastight crimped; acc. to DIN 46228, Part 4/09.90; yellow



Item No.: 216-108

Ferrule; Sleeve for 6 mm² / AWG 10; uninsulated; electro-tin plated; silver-colored

1.2.2 Strain relief

1.2.2.1 Strain relief plate



Item No.: 831-503

Strain relief plate; for female and male connectors; 15 mm wide; 1 part; Pin spacing 7.62 mm; light gray

Installation Notes

Conductor termination

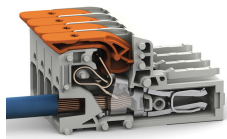

Insert solid conductors via push-in termination.

Conductor removal

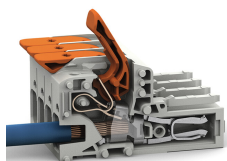

Insert fine-stranded conductors – and remove all conductors – via operating tool.