

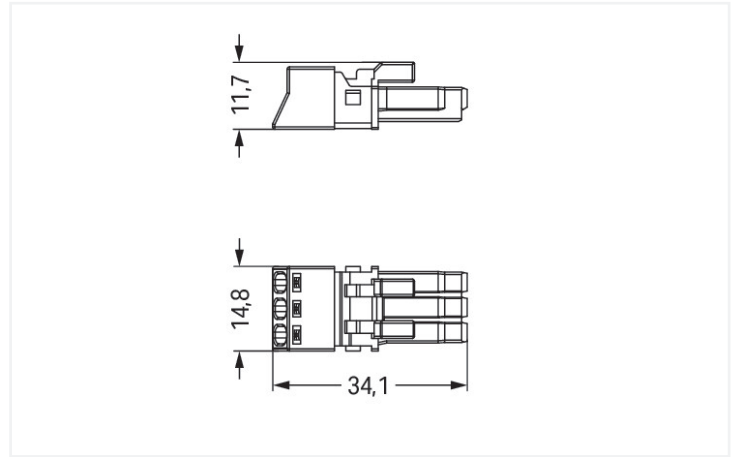

Color: ■ black



Dimensions in mm

Female connector/socket WINSTA® MINI with protection type IP20

Use effective pluggable connections instead of laborious screw connections: With the WINSTA® MINI female connector/socket 3-pole. WAGO pluggable installation connectors are useful when requirements repeat or are planned on a defined pattern, for example for installing grid lighting or flush-mount lighting. The coding options reduce installation errors, allowing fast, maintenance-free wiring of all components. The WINSTA® MINI pluggable installation connector with A coding in white or black is usually used for general mains applications in power distribution. Due to its particularly minimal dimensions, our WINSTA® MINI Pluggable Connection System with Push-in CAGE CLAMP® spring pressure connection technology is especially suitable in very tight spaces, i.e., for installations when very little room is available.

Lower costs through fast commissioning and elimination of service expenses – solutions from WINSTA® MINI

The WINSTA® Pluggable Connection System allows pluggable electrical installation. This significantly reduces the need for servicing and lowers costs. Choose quality and durability – with marking from WAGO makes the installation of electrical components significantly easier.

- effective protection against mismatching
- compact design for conductors with a cross-section up to 1.5 mm²
- for any mains application
- custom-engineered solutions
- rapid, structured electrical installation

Notes

General safety information

NOTICE: Observe installation and safety instructions!

- Nur von Elektrofachkraft oder einer für die Tätigkeit elektrisch unterwiesenen Person (EUP nach DIN VDE 0105-100) anzuwenden!
- Nicht unter Spannung/Last installieren!
- Nur für bestimmungsgemäßen Gebrauch einsetzen!
- Nationale Vorschriften/Normen/Richtlinien beachten!
- Technische Daten der Produkte beachten!
- Auf die richtige Polbelegung achten!
- Keine beschädigten/verschmutzten Komponenten verwenden!
- Leiterarten, -querschnitte, Abisolierlängen und Leitungsdurchmesser beachten!
- Leiter bis zum Anschlag einführen!
- Nur mit Verriegelungsklinke und Zugentlastung verwenden!
- Originalzubehör verwenden!

To be sold only with installation instructions!

Electrical data

Ratings per	IEC/EN 60664-1			Approvals per	UL 1977
Overvoltage category	III	III	II	Rated voltage	600 V
Pollution degree	3	2	2	Rated current	14 A
Nominal voltage	250 V	-	-		
Rated impulse withstand voltage	4 kV	-	-		
Rated current	16 A	-	-		

General information

Note on contact resistance	approx. 1 mΩ of contact resistance approx. 0.25 mΩ contact transition plug/ socket
----------------------------	--

Connection Data

Clamping units	3	Connection 1	
Total number of potentials	3	Connection technology	Push-in CAGE CLAMP®
		Actuation type	Operating tool Push-in
		Nominal cross-section	1.5 mm ² / 16 AWG
		Solid conductor	0.25 ... 1.5 mm ² / 22 ... 16 AWG
		Solid conductor; push-in termination	0.75 ... 1.5 mm ² / 20 ... 16 AWG
		Stranded conductor	0.25 ... 1 mm ² / 22 ... 18 AWG
		Fine-stranded conductor	0.25 ... 1.5 mm ² / 22 ... 16 AWG
		Fine-stranded conductor; with insulated ferrule	0.25 ... 0.75 mm ² / 22 ... 20 AWG
		Fine-stranded conductor; with uninsulated ferrule	0.25 ... 0.75 mm ² / 22 ... 20 AWG
		Fine-stranded conductor; with ferrule; push-in termination	0.75 mm ² / 20 AWG
		Strip length	9 mm / 0.35 inches
		Pole number	3
		Conductor entry direction to mating direction	0°

Physical data

Pin spacing	4.4 mm / 0.173 inches
Width	15 mm / 0.591 inches
Height	11.7 mm / 0.461 inches
Depth	34.1 mm / 1.343 inches

Mechanical data

Use	General mains applications
Coding	A
Variable coding	No
Marking	L ⊕ N
Potential marking	L ⊕ N
Mating force of a plug-in connection	approx. 20 ... 70 N (depending on pole number)
Retention force of a plug-in connection	Locked: > 80 N
Unmating force of a plug-in connection	Unlocked: approx. 20 ... 70 N (depending on pole number)
Number of mating cycles	200, without resistive load
Protection type	IP20; IP40 with strain relief housing

Plug-in connection

Contact type (pluggable connector)	Female connector/socket
Connector (connection type)	for conductor
Mismating protection	Yes
Note on mismating protection	All WINSTA® components are 100% protected against mismating when: a.) plugging different numbers of poles b.) plugging while rotated 180 c.) plugging while laterally staggered d.) plugging one pole
Locking lever	Can be retrofitted
Locking of plug-in connection	Locking lever
Note on locking system	All connectors for mounted installations (snap-in versions for lighting fixtures or devices, all types of PCB and distribution connectors) are factory-equipped with locking levers to ensure plugs and sockets are securely locked. Additional locking levers are only required for flying leads (plug/socket).

Material data

Note (material data)	Information on material specifications can be found here
Color	black
Cover color	gray
Material group	I
Insulation material (main housing)	Polyamide (PA66)
Flammability class per UL94	V0
Clamping spring material	Chrome-nickel spring steel (CrNi)
Contact material	Copper or copper alloy; surface-treated
Contact Plating	Tin
Fire load	0.073 MJ
Weight	3.8 g

Environmental requirements

Processing temperature	-5 ... +40 °C
Continuous operating temperature	-35 ... +85 °C
Note on continuous operating temperature	Insulating parts for temperatures ≤ 105 °C

Commercial data

Product Group	20 (Winsta)
PU (SPU)	50 pcs
Packaging type	Box
Country of origin	PL
GTIN	4055143548519
Customs tariff number	85366990990

Product Classification

UNSPSC	39121402
eCl@ss 10.0	27-44-06-05
eCl@ss 9.0	27-44-06-05
ETIM 9.0	EC002560
ETIM 10.0	EC002560
ECCN	NO US CLASSIFICATION

Environmental Product Compliance	
RoHS Compliance Status	Compliant, No Exemption

Approvals / Certificates

General approvals			Declarations of conformity and manufacturer's declarations		
Approval	Standard	Certificate Name	Approval	Standard	Certificate Name
CCA DEKRA Certification B.V.	EN 61535	71-123231	EU-Declaration of Conformity WAGO GmbH & Co. KG	-	-
CCA DEKRA Certification B.V.	IEC 61535	NL-85020	UK-Declaration of Conformity WAGO GmbH & Co. KG	-	-
cURus Underwriters Laboratories Inc.	UL 1977	E45171			

Approvals for marine applications

Approval	Standard	Certificate Name
ABS American Bureau of Shipping	Steel Vessel Rules	24-0095973-PDA
DNV GL Det Norske Veritas, Germanischer Lloyd	-	TAE00001Z6
LR Lloyds Register	EN 61535	LR23317167TA
PRS Polski Rejestr Statków	-	TE/1096/880590/23

Downloads

Environmental Product Compliance	
Compliance Search	
Environmental Product Compliance 890-203	↓

Documentation

Bid Text			
890-203	19.02.2019	xml 2.95 KB	↓
890-203	08.06.2015	doc 23.00 KB	↓

CAD/CAE-Data

CAD data	CAE data
2D/3D Models 890-203	EPLAN Data Portal 890-203
	WSCAD Universe 890-203
	ZUKEN Portal 890-203

1 Compatible Products

1.1 System counterpart

1.1.1 Cable assembly



Item No.: 891-8993/205-101

pre-assembled connecting cable; Eca; Plug/open-ended; 3-pole; Cod. A; 1 m; 1,00 mm²; black

Item No.: 891-8993/005-101

pre-assembled interconnecting cable; Eca; Socket/plug; 3-pole; Cod. A; 1 m; 1,00 mm²; black

1.1.2 Distribution connector



Item No.: 890-634

h-distribution connector; 3-pole; Cod. A; 1 input; 2 outputs; outputs on one side; 2 locking levers; black

Item No.: 890-636

h-distribution connector; 3-pole; Cod. A; 1 input; 2 outputs; outputs on one side; 3 locking levers; for flying leads; black

Item No.: 890-606

T-distribution connector; 3-pole; Cod. A; 1 input; 2 outputs; 2 locking levers; black

Item No.: 890-615

T-distribution connector; 3-pole; Cod. A; 1 input; 2 outputs; 3 locking levers; for flying leads; black

1.1.3 Male connector/plug



Item No.: 890-813/011-000

Plug for PCBs; angled; 3-pole; Cod. A; black

Item No.: 890-813

Plug for PCBs; straight; 3-pole; Cod. A; black

Item No.: 890-213

Plug; 3-pole; Cod. A; 1,50 mm²; black

Item No.: 890-113

Plug; with strain relief housing; 3-pole; 1,50 mm²; black



Item No.: 890-713

Snap-in plug; 3-pole; Cod. A; 1,50 mm²; black

1.2 Required Accessories

1.2.1 Locking system

1.2.1.1 Locking system



Item No.: 890-111

Locking lever; for flying leads; for tool operation; black

Item No.: 890-131

Locking lever; for flying leads; for tool operation; white

Item No.: 890-101

Locking lever; for manual operation; black

Item No.: 890-121

Locking lever; for manual operation; white

1.2.2 Strain relief

1.2.2.1 Strain relief housing



Item No.: 890-503

Strain relief housing; 3-pole; with locking clip; for 1 cable; 4.5 ... 10.0 mm; 37 mm; black



Item No.: 890-513

Strain relief housing; 3-pole; with locking clip; for 1 cable; 4.5 ... 10.0 mm; 37 mm; white

1.3 Optional Accessories

1.3.1 Cover

1.3.1.1 Cover



Item No.: 897-2001

Protective cap; Type1; for sockets and plugs; PVC; red

1.3.2 Installation

1.3.2.1 Mounting accessories



Item No.: 890-310

Mounting carrier; 2- to 5-pole; for flying leads; black



Item No.: 890-311

Mounting carrier; 2- to 5-pole; for flying leads; white

1.3.3 Shield termination

1.3.3.1 Shield termination



Item No.: 890-523

Shield connecting plate; 3-pole; for sockets and plugs; silver-colored

1.3.4 Tool

1.3.4.1 Operating tool



Item No.: 890-383

Operating tool; 3-way; green



Item No.: 210-719

Operating tool; Blade: 2.5 x 0.4 mm; with a partially insulated shaft

Installation Notes

Conductor termination

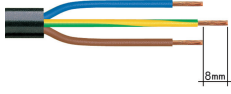

1. Strip length, outer insulation = 30 mm (2-pole), 37 mm (3-pole), 45 mm (4- and 5-pole)
2. Strip length = 9 mm
3. Extended ground conductor = 8 mm

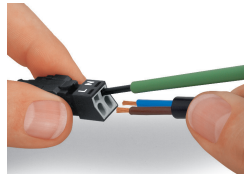

To terminate fine-stranded conductors, open the clamping unit via screwdriver – 2.5 mm blade width – and insert a stripped conductor until it hits the backstop. Terminate solid conductors by simply pushing them in.

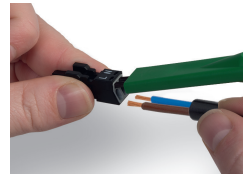

To terminate fine-stranded conductors, open clamping units via operating tool (890-382) and insert stripped conductors until they hit backstop. Terminate solid conductors by simply pushing them in.

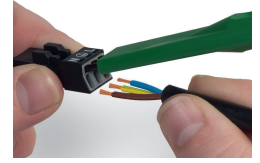

To terminate fine-stranded conductors, open clamping units via operating tool (890-383) and insert stripped conductors until they hit backstop. Terminate solid conductors by simply pushing them in.

Installation

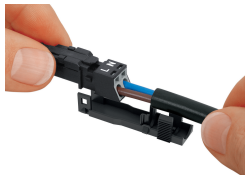

Latch the wired connector into the base of the strain relief housing.



Push down strain relief clamp by hand.



Push down strain relief clamp with 2.5 mm screwdriver alternately on both sides.

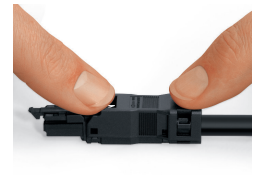

Latch the top of the strain relief housing.



The printed marking of the connector is clearly visible in the openings of the strain relief housing.

Shield termination



Connector with shield termination



Apply the shield to the sheathed cable.
Strip length, outer insulation = 30 mm
Shield length = 8 mm



Push the shield connecting plate into the connector until fully inserted.



First insert the wired connector into strain relief housing, then snap clamp and cover.