

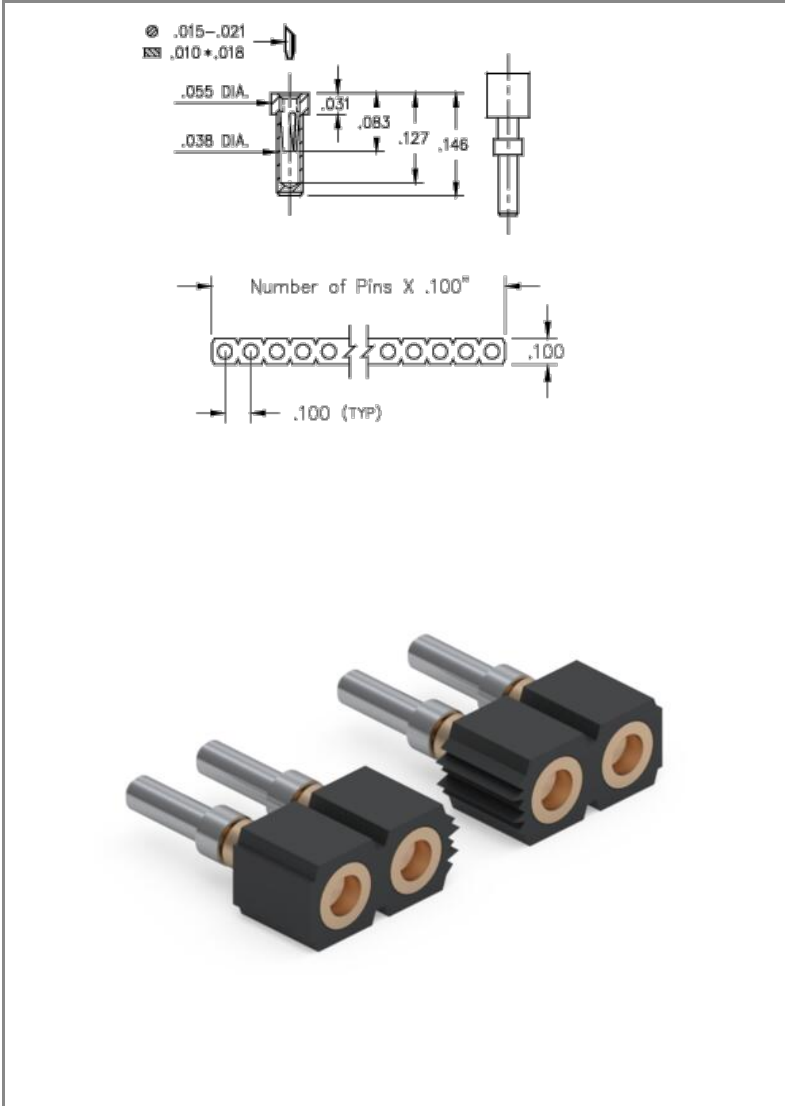

PRODUCT NUMBER: 714-91-152-31-007000

www.mill-max.com
DATA SHEET



General Info	
Description ¹ :	Plastic Carrier with Low Profile Receptacles
Type:	Interconnect
Category:	Single In Line Receptacle Carrier Socket
Mounting Style:	Through Hole Solder Mount
# Pins:	52
Packaging ² :	Packaged in Box or Tube
Rows:	Single Row
ECCN:	Contact Factory
HTSUS:	8536.90.4040
Product Lifecycle:	Active
Country Of Origin:	USA

714-91-152-31-007000- SPECIFICATIONS

Environmental Specs	
Temperature Range ³ :	-55/+125° C
Shock ⁴ :	No Elect. Discontinuity > 1μs @ 50g
Vibration ⁵ :	No Elect. Discontinuity > 1μs @ 10-2000HZ, 15 G
Moisture Sensitivity Level (MSL):	1 (Unlimited)
REACH Status:	REACH Unaffected

Mechanical Specs	
Mechanical life (Durability) ⁶ :	1,000 Cycles Minimum

Materials	
Loose Pin/Receptacle # (Material):	1407 (Brass Alloy)
Shell Plating:	200 μ" Tin/Lead(93/7) over 100 μ" Nickel
Inner Contact #:	11
# Contact Fingers:	3
Inner Contact Material:	Beryllium Copper
Inner Contact Plating:	10 μ" Gold over 50 μ" Nickel
Insulator Material:	High Temp Thermoplastic

Technical Specs	
Pitch:	.100" (2,540mm)

Electrical Specs	
Current Rating ⁷ :	3 Amps
Rated Voltage:	100 VRMS/150 VDC
Insulation Resistance:	10,000 MΩ min.
Dielectric Withstanding Voltage:	1,000 VRMS min.

NOTES:

1. Standard Tolerances

Assembly tolerance: +/- .010" (.25mm)

Connector Length "L"

Connector Length "L"	Tolerance
$L \leq 2"$ ($L \leq 50.8$ mm)	+/- .005" (+/- .127 mm)
$2 < L \leq 3"$ ($50.8 < L \leq 76.2$ mm)	+ .007 / - .006" (+ .178 / - .152 mm)
$3 < L \leq 4"$ ($76.2 < L \leq 101.6$ mm)	+ .009 / - .007" (+ .229 / - .178 mm)
$4 < L \leq 5"$ ($101.6 < L \leq 127$ mm)	+ .011 / - .008" (+ .279 / - .203 mm)
$5 < L \leq 6.4"$ ($127 < L \leq 162.56$ mm)	+ .013 / - .009" (+ .330 / - .229 mm)

Insulator width: +/- .005 (.13mm)

Insulator height: +/- .005 (.13mm)

Co-planarity of SMT connectors: .005" (.13mm) up to 1" (25.4mm) in connector length

Insulator Flatness: .005" (.13mm) up to 1" (25.4mm) in connector length

Pin Length: +/- .005 (.13mm)

Pin Diameter: +/- .002 (.051mm)

Pin Angle: +/- 2°

- Not all part numbers in the series may be packaged in tubes. Some specific part numbers may be packaged in a box.
- Per IEC 60512-11-(4,-9,-10,-12)
- For discrete pin only. Per IEC 60512-6-3: Test 6c: Shock
- For discrete pin only. Per IEC 60512-6-4: Test 6d: Vibration (sinusoidal)
- Receptacles are capable of 1,000 Minimum insertion/extraction cycles for a broad range of applications. Mating pin size, shape and finish, along with application specific variables, will affect the life of a receptacle contact.
- Per IEC 60512-5-1, Current Carrying Capacity (evaluated at 10° C Temp. Rise)

ADDITIONAL NOTES AND SPECIFICATIONS

In the interest of improved design, quality and performance, Mill-Max reserves the right to make changes in its specifications without prior notice. Specifications and tolerances are provided wherever possible. The tolerance on dimensions of critical to function features is typically held tighter than the stated standard tolerances, such as press-fits, holes and lengths affecting the coplanarity of SMT products. Due to the wide variety of interconnects Mill-Max offers, the specific tolerances vary from product to product. If you need information regarding the tolerance of a particular part, please contact Technical Services.

RELATED LINKS AND DOCUMENTS

- Engineering Notebook: [How to Use Pin Receptacle Carriers](#)
- Environmental Compliance: <https://www.mill-max.com/rohs>