

Data Sheet | Item Number: 2000-2203

Double-deck terminal block; Through/through terminal block; L/N; without marker carrier; Blue conductor entry upper deck; for DIN-rail 35 x 15 and 35 x 7.5; Push-in CAGE CLAMP®; 1,00 mm²; gray

<https://www.wago.com/2000-2203>

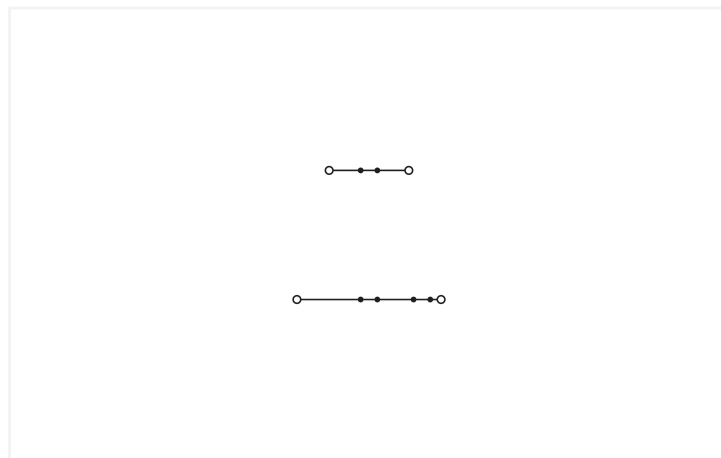
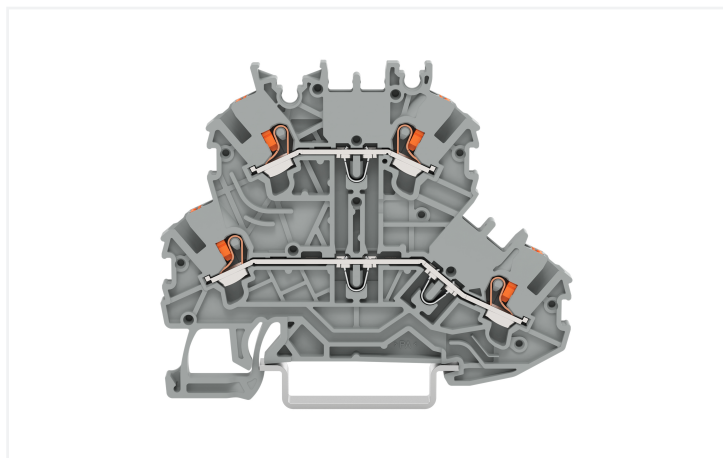

Color: ■ gray

Similar to illustration

Similar to illustration

Double-deck terminal block, 2000 Series, Push-in CAGE CLAMP®

Seamless electrical installations are guaranteed with this double-deck terminal block (item number 2000-2203). Strip lengths must be between 9 and 11 mm when connecting conductors to this double-deck terminal block. The double-deck terminal block also serves as a through terminal block. This product features conductor terminals and utilizes Push-in CAGE CLAMP®. Our Push-in CAGE CLAMP® is a universal, maintenance-free connection solution for all conductor types, boasting a key feature: both solid and fine-stranded conductors with ferrules can be directly inserted without the need for tools or any preparation, such as crimping the ferrule. This double-deck terminal block is suitable for conductor cross sections ranging from 0.14 mm² to 1.5 mm².

This product is designed for specific Ex applications (please refer to the product datasheet).

Electrical data

Ratings per	IEC/EN 60947-7-1		
Overvoltage category	III	III	II
Pollution degree	3	2	2
Nominal voltage	500 V	-	-
Rated impulse withstand voltage	6 kV	-	-
Rated current	13.5 A	-	-
Current at conductor cross-section (max.) mm²	16 A	-	-

Approvals per	UL 1059		
Use group	B	C	D
Rated voltage	300 V	300 V	-
Rated current	15 A	15 A	-

Approvals per	CSA 22.2 No 158		
Use group	B	C	D
Rated voltage	600 V	600 V	-
Rated current	10 A	10 A	-

Ex information	
Reference to hazardous areas	See "Downloads – Documentation – Additional Information: Technical Section; Technical Explanations"
Ratings per	ATEX: PTB 11 ATEX 1041 U / IECEx: PTB 11.0093U (Ex eb IIC Gb)
Rated voltage EN (Ex e II)	350 V
Rated current (Ex e II)	13 A
Rated current (Ex e II) with jumper	12 A

Power Loss

Power loss, per pole (potential)	0.4338 W
Rated current I_N for power loss specification	13.5 A
Resistance value for specified, current-dependent power loss	0.00238 Ω

General information

Wiring direction	Front-entry wiring
------------------	--------------------

Connection Data

Clamping units	4
Total number of potentials	2
Number of levels	2
Number of jumper slots	4

Connection 1

Connection technology	Push-in CAGE CLAMP®
Number of connection points	2
Actuation type	Operating tool
Connectable conductor materials	Copper
Nominal cross-section	1 mm ²
Solid conductor	0.14 ... 1.5 mm ² / 24 ... 16 AWG
Solid conductor; push-in termination	0.5 ... 1.5 mm ² / 20 ... 16 AWG
Fine-stranded conductor	0.14 ... 1.5 mm ² / 24 ... 16 AWG
Fine-stranded conductor; with insulated ferrule	0.14 ... 0.75 mm ² / 24 ... 18 AWG
Fine-stranded conductor; with ferrule; push-in termination	0.5 ... 0.75 mm ² / 20 ... 18 AWG
Note (conductor cross-section)	Depending on the conductor characteristic, a conductor with a smaller cross-section can also be inserted via push-in termination.
Strip length	9 ... 11 mm / 0.35 ... 0.43 inches
Wiring direction	Front-entry wiring

Connection 2

Number of connection points	2
-----------------------------	---

Physical data

Width	3.5 mm / 0.138 inches
Height	69.7 mm / 2.744 inches
Depth from upper-edge of DIN-rail	51.7 mm / 2.035 inches

Mechanical data

Potential marking	L/N
Mounting type	DIN-35 rail
Marking level	Center/side marking

Material data

Note (material data)	Information on material specifications can be found here
Color	gray
Material group	I
Insulation material (main housing)	Polyamide (PA66)
Flammability class per UL94	V0
Fire load	0.132 MJ
Weight	7.1 g

Environmental requirements

Processing temperature	-35 ... +85 °C
Continuous operating temperature	-60 ... +105 °C

Environmental Testing

Test specification: Railway applications – Rolling stock – Electronic equipment	DIN EN 50155 (VDE 0115-200):2022-06
Test procedure: Railway applications – Rolling stock equipment – Vibration and shock tests	DIN EN 61373 (VDE 0115-0106):2011-04
Spectrum/Mounting location	Service life test, Category 1, Class A/B
Functional test with noise-like oscillations	Test passed according to Section 8 of the standard
Frequency	$f_1 = 5 \text{ Hz}$ to $f_2 = 150 \text{ Hz}$
Acceleration	0.101g (highest test level used for all axes)
Test duration per axis	10 min.
Test directions	X, Y and Z axes
Monitoring of contact faults and interruptions	Passed
Voltage drop measurement before and after each axis	Passed
Simulated service life test through increased levels of noise-like oscillations	Test passed according to Section 9 of the standard
Frequency	$f_1 = 5 \text{ Hz}$ to $f_2 = 150 \text{ Hz}$
Acceleration	0.572g (highest test level used for all axes)
Test duration per axis	5 h
Test directions	X, Y and Z axes
Extended testing: Monitoring of contact faults and interruptions	Passed
Extended testing: Voltage drop measurement before and after each axis	Passed
Shock test	Test passed according to Section 10 of the standard
Shock pulse form	Half sine
Acceleration	5g (highest test level used for all axes)
Shock duration	30 ms
Number of shocks (per axis)	3 pos. und 3 neg.
Test directions	X, Y and Z axes
Extended testing: Monitoring of contact faults and interruptions	Passed
Extended testing: Voltage drop measurement before and after each axis	Passed
Vibration and shock stress for rolling stock equipment	Passed

Commercial data

Product Group	22 (TOPJOB S)
PU (SPU)	50 pcs
Packaging type	Box
Country of origin	CN
GTIN	4055143267717
Customs tariff number	85369010000

Product Classification

UNSPSC	39121410
eCl@ss 10.0	27-14-11-20
eCl@ss 9.0	27-14-11-20
ETIM 9.0	EC000897
ETIM 10.0	EC000897
ECCN	NO US CLASSIFICATION

Environmental Product Compliance

RoHS Compliance Status	Compliant, No Exemption
------------------------	-------------------------

Approvals / Certificates

General approvals



Approval	Standard	Certificate Name
CCA DEKRA Certification B.V.	EN 60947	NTR NL 7962
CSA DEKRA Certification B.V.	C22.2	2130762
KEMA/KEUR DEKRA Certification B.V.	EN 60947	71-125928
UL Underwriters Laboratories Inc.	UL 1059	E45172

Declarations of conformity and manufacturer's declarations



Approval	Standard	Certificate Name
ATEX-Attestation of Conformity WAGO GmbH & Co. KG	-	-
EU-Declaration of Conformity WAGO GmbH & Co. KG	-	-
Railway WAGO GmbH & Co. KG	-	Railway Ready
UK-Declaration of Conformity WAGO GmbH & Co. KG	-	-

Approvals for hazardous areas



Approval	Standard	Certificate Name
AEx Underwriters Laboratories Inc.	UL 60079	E185892 (AEx eb IIC resp. Ex eb IIC)
ATEX Physikalisch Technische Bundesanstalt	EN 60079	PTB 11 ATEX 1041 U (II 2 G Ex eb IIC Gb bzw. I M 2 Ex eb I Mb)
CCC CNEX	GB/T 3836.3	2020312313000182 (Ex eb IIC Gb, Ex eb I Mb)
IECEx Physikalisch Technische Bundesanstalt	IEC 60079	IECEx PTB 11.0093U (Ex e IIC Gb or Ex e I Mb)

Downloads

Environmental Product Compliance

Compliance Search	
Environmental Product Compliance 2000-2203	↓

Documentation

Bid Text			
2000-2203	19.02.2019	xml 3.80 KB	↓
2000-2203	07.08.2018	docx 14.59 KB	↓

CAD/CAE-Data

CAD data	
2D/3D Models 2000-2203	↓

CAE data	
EPLAN Data Portal 2000-2203	↓
WSCAD Universe 2000-2203	↓
ZUKEN Portal 2000-2203	↓

1 Compatible Products

1.1 Required Accessories

1.1.1 End plate

1.1.1.1 End plate



[Item No.: 2000-2291](#)
End plate; 0.7 mm thick; gray

[Item No.: 2000-2292](#)
End plate; 0.7 mm thick; orange

1.2 Optional Accessories

1.2.1 DIN-rail

1.2.1.1 Mounting accessories



[Item No.: 210-196](#)
Aluminum carrier rail; 35 x 8.2 mm; 1.6 mm thick; 2 m long; unslotted; similar to EN 60715; silver-colored



[Item No.: 210-198](#)
Copper carrier rail; 35 x 15 mm; 2.3 mm thick; 2 m long; unslotted; according to EN 60715; copper-colored



[Item No.: 210-197](#)
Steel carrier rail; 35 x 15 mm; 1.5 mm thick; 2 m long; slotted; similar to EN 60715; silver-colored



[Item No.: 210-114](#)
Steel carrier rail; 35 x 15 mm; 1.5 mm thick; 2 m long; unslotted; similar to EN 60715; silver-colored



[Item No.: 210-118](#)
Steel carrier rail; 35 x 15 mm; 2.3 mm thick; 2 m long; unslotted; according to EN 60715; silver-colored



[Item No.: 210-115](#)
Steel carrier rail; 35 x 7.5 mm; 1 mm thick; 2 m long; slotted; according to EN 60715; "Hole width 18 mm; silver-colored



[Item No.: 210-112](#)
Steel carrier rail; 35 x 7.5 mm; 1 mm thick; 2 m long; slotted; according to EN 60715; "Hole width 25 mm; silver-colored



[Item No.: 210-113](#)
Steel carrier rail; 35 x 7.5 mm; 1 mm thick; 2 m long; unslotted; according to EN 60715; silver-colored

1.2.2 Ferrule

1.2.2.1 Ferrule



Item No.: 216-241

Ferrule; Sleeve for 0.5 mm² / 20 AWG; insulated; electro-tin plated; electrolytic copper; gastight crimped; acc. to DIN 46228, Part 4/09.90; white



Item No.: 216-242

Ferrule; Sleeve for 0.75 mm² / 18 AWG; insulated; electro-tin plated; electrolytic copper; gastight crimped; acc. to DIN 46228, Part 4/09.90; gray



Item No.: 216-243

Ferrule; Sleeve for 1 mm² / AWG 18; insulated; electro-tin plated; electrolytic copper; gastight crimped; acc. to DIN 46228, Part 4/09.90; red

1.2.3 Installation

1.2.3.1 Cover



Item No.: 709-156

Cover; Type 3; suitable for cover carrier, type 3; 1 m long; transparent

1.2.3.2 Cover carrier



Item No.: 709-169

Cover carrier; Type 3; incl. fixing/retaining screws and knurled nut; suitable for 279 to 282 and 880 Series rail-mounted terminal blocks; suitable for 264 Series miniature rail-mounted terminal blocks; suitable for 270 Series sensor and actuator terminal blocks; gray

1.2.4 Jumper

1.2.4.1 Jumper



Item No.: 2000-406/020-000

Delta jumper; insulated; light gray



Item No.: 2000-410/000-006

Jumper; 10-way; insulated; blue



Item No.: 2000-410

Jumper; 10-way; insulated; light gray



Item No.: 2000-410/000-005

Jumper; 10-way; insulated; red



Item No.: 2000-402/000-006

Jumper; 2-way; insulated; blue



Item No.: 2000-402

Jumper; 2-way; insulated; light gray



Item No.: 2000-402/000-005

Jumper; 2-way; insulated; red



Item No.: 2000-402/000-018

Jumper; 2-way; insulated; yellow-green



Item No.: 2000-403/000-006

Jumper; 3-way; insulated; blue



Item No.: 2000-403

Jumper; 3-way; insulated; light gray



Item No.: 2000-403/000-005

Jumper; 3-way; insulated; red



Item No.: 2000-404/000-006

Jumper; 4-way; insulated; blue



Item No.: 2000-404

Jumper; 4-way; insulated; light gray



Item No.: 2000-404/000-005

Jumper; 4-way; insulated; red



Item No.: 2000-405/000-006

Jumper; 5-way; insulated; blue



Item No.: 2000-405

Jumper; 5-way; insulated; light gray



Item No.: 2000-405/000-005

Jumper; 5-way; insulated; red



Item No.: 2000-406/000-006

Jumper; 6-way; insulated; blue



Item No.: 2000-406

Jumper; 6-way; insulated; light gray



Item No.: 2000-406/000-005

Jumper; 6-way; insulated; red



Item No.: 2000-407/000-006

Jumper; 7-way; insulated; blue



Item No.: 2000-407

Jumper; 7-way; insulated; light gray



Item No.: 2000-407/000-005

Jumper; 7-way; insulated; red



Item No.: 2000-408/000-006











Jumper; 8-way; insulated; blue

1.2.4.1 Jumper

 Item No.: 2000-408 Jumper; 8-way; insulated; light gray	 Item No.: 2000-408/000-005 Jumper; 8-way; insulated; red	 Item No.: 2000-409/000-006 Jumper; 9-way; insulated; blue	 Item No.: 2000-409 Jumper; 9-way; insulated; light gray
 Item No.: 2000-409/000-005 Jumper; 9-way; insulated; red	 Item No.: 2000-440 Jumper; from 1 to 10; insulated; light gray	 Item No.: 2000-433/000-006 Jumper; from 1 to 3; insulated; blue	 Item No.: 2000-433 Jumper; from 1 to 3; insulated; light gray
 Item No.: 2000-433/000-005 Jumper; from 1 to 3; insulated; red	 Item No.: 2000-434 Jumper; from 1 to 4; insulated; light gray	 Item No.: 2000-435 Jumper; from 1 to 5; insulated; light gray	 Item No.: 2000-436 Jumper; from 1 to 6; insulated; light gray
 Item No.: 2000-437 Jumper; from 1 to 7; insulated; light gray	 Item No.: 2000-438 Jumper; from 1 to 8; insulated; light gray	 Item No.: 2000-439 Jumper; from 1 to 9; insulated; light gray	 Item No.: 2000-405/011-000 Star point jumper; 3-way; insulated; light gray
 Item No.: 2000-492 Vertical jumper; insulated; light gray	 Item No.: 210-103 Wire commoning chain; insulated; black	 Item No.: 210-123 Wire commoning chain; insulated; blue	

1.2.5 Marking

1.2.5.1 Marker

 Item No.: 793-3501 WMB marking card; as card; plain; snap-on type; white	 Item No.: 2009-113/000-006 WMB-Inline; for Smart Printer; 2300 pieces on roll; plain; snap-on type; blue	 Item No.: 2009-113/000-007 WMB-Inline; for Smart Printer; 2300 pieces on roll; plain; snap-on type; gray	 Item No.: 2009-113/000-023 WMB-Inline; for Smart Printer; 2300 pieces on roll; plain; snap-on type; green
 Item No.: 2009-113/000-017 WMB-Inline; for Smart Printer; 2300 pieces on roll; plain; snap-on type; light green	 Item No.: 2009-113/000-012 WMB-Inline; for Smart Printer; 2300 pieces on roll; plain; snap-on type; orange	 Item No.: 2009-113/000-005 WMB-Inline; for Smart Printer; 2300 pieces on roll; plain; snap-on type; red	 Item No.: 2009-113/000-024 WMB-Inline; for Smart Printer; 2300 pieces on roll; plain; snap-on type; violet
 Item No.: 2009-113 WMB-Inline; for Smart Printer; 2300 pieces on roll; plain; snap-on type; white	 Item No.: 2009-113/000-002 WMB-Inline; for Smart Printer; 2300 pieces on roll; plain; snap-on type; yellow		

1.2.5.2 Marker carrier

 Item No.: 2000-121 Adaptor; gray

1.2.5.3 Marking strip

 Item No.: 2009-110 Marking strips; for Smart Printer; on reel; not stretchable; plain; snap-on type; white

1.2.6 Protective warning marker

1.2.6.1 Cover



Item No.: 2000-115

Protective warning marker; for 5 terminal blocks; with high-voltage symbol, black; yellow

1.2.7 Push-in type wire jumper

1.2.7.1 Jumper



Item No.: 2009-404

Push-in type wire jumper; 0.75 mm²; insulated; 110 mm long; gray



Item No.: 2009-406

Push-in type wire jumper; 0.75 mm²; insulated; 250 mm long; gray



Item No.: 2009-402

Push-in type wire jumper; 0.75 mm²; insulated; 60 mm long; gray

1.2.8 Screwless end stop

1.2.8.1 Mounting accessories



Item No.: 249-117

Screwless end stop; 10 mm wide; for DIN-rail 35 x 15 and 35 x 7.5; gray



Item No.: 249-116

Screwless end stop; 6 mm wide; for DIN-rail 35 x 15 and 35 x 7.5; gray

1.2.9 Test and measurement

1.2.9.1 Testing accessories



Item No.: 2009-174

Test plug adapter; for 4 mm Ø test plugs; for testing TOPJOB®S rail-mounted terminal blocks; gray



Item No.: 2009-182

Testing tap; for max. 2.5 mm²; tool-free connection for individual test wires 0.08 - 2.5 mm; gray

1.2.10 Tool

1.2.10.1 Operating tool



Item No.: 210-719

Operating tool; Blade: 2.5 x 0.4 mm; with a partially insulated shaft



Item No.: 210-648

Operating tool; Blade: 2.5 x 0.4 mm; with a partially insulated shaft; angled; short



Item No.: 210-647

Operating tool; Blade: 2.5 x 0.4 mm; with a partially insulated shaft; multicoloured

Installation Notes

Conductor termination



All conductor types at a glance

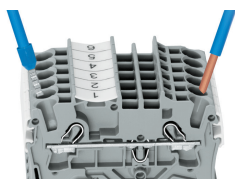

Push-in termination of solid and ferruled conductors

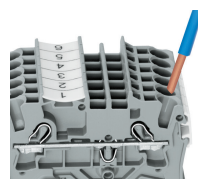

Inserting a conductor via push-in termination:
Solid conductors with cross-sections from either one size above, or up to two sizes below, the rated cross-section can be simply pushed in – no tools needed.

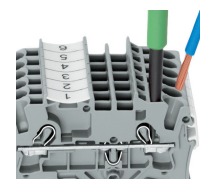

Inserting a conductor via operating tool:
Connecting fine-stranded conductors without ferrules, or small cross-sectional conductors that cannot be pushed in, is performed similarly to the original CAGE CLAMP® – just use an operating tool.
Advantage:
To open the clamp, the operating tool is inserted vertically. The conductor entry is less than 15 degrees for easier wiring.

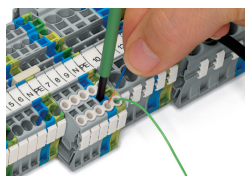

Conductor termination – insulation stop

Commoning

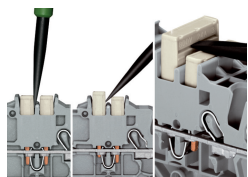

Removing a push-in type jumper bar:
Insert the operating tool between the jumper and partition wall of the dual jumper slots, then lift up the jumper.
Place the operating tool in the center of jumpers for up to five contacts (see above), or alternately on both sides for jumpers with more than five contacts.

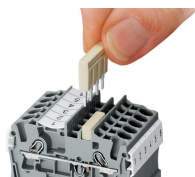

Insert push-in type jumper bar and push down until it hits backstop.

Commoning

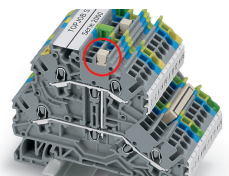

Commoning two levels via double-deck vertical jumper (Item No. 2000-492).

Marking

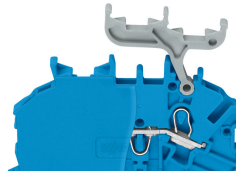
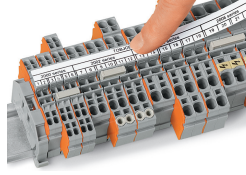
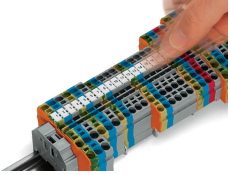

Snapping WMB Inline markers into marker slots.

Double-Deck Terminal Blocks
A double-deck marker carrier (Item No. 2000-121) can be retrofitted to double-deck terminal blocks without a marker carrier.