

## Data Sheet | Item Number: 890-253

Plug; 3-pole; Cod. B; 1,50 mm<sup>2</sup>; gray

<https://www.wago.com/890-253>



Color: ■ gray

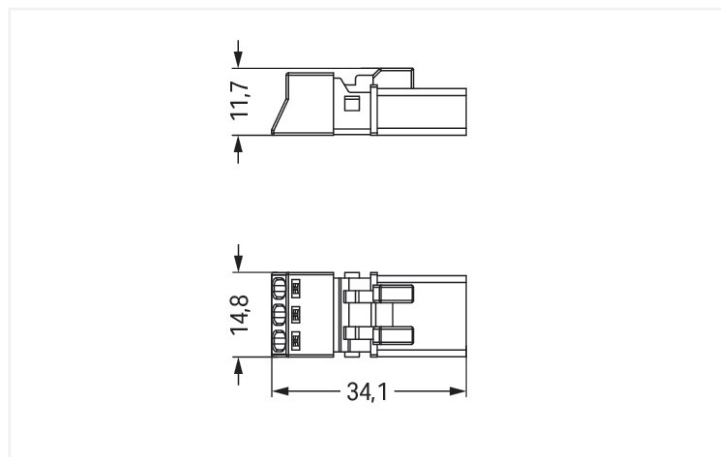

Dimensions in mm

### Male connector/plug WINSTA® MINI 3-pole

The WINSTA® MINI male connector/plug B coding allows assembly of solid and fine-stranded conductors. On PCBs, in control cabinets or for connecting lights – pluggable installation connectors from WAGO allow you to establish connections according to various requirements in seconds. For greater protection in electrical installations, the pluggable installation connector is provided with mechanical protection against mismatching. Solutions like the WINSTA® MINI pluggable installation connectors with B coding are appropriate for process control, such as for lighting or within data networks. WINSTA® MINI is our response to the trend toward miniaturisation. Our smallest pluggable connection system is primarily suited for lights, for instance, since as a result of LED technology; due to complex systems, these offer less and less space for the connection technology.

Push-in CAGE CLAMP® spring pressure connection technology – pluggable installation instead of laborious screw connections!

WINSTA® is the pluggable connection system that is perfectly tailored to the strict requirements of electrical installation. It ensures error-free installation of cables and components, quickly and reliably. Take advantage of the pluggable version of our maintenance-free spring pressure connection technology too! Plan your installation with with protection type IP20 from WAGO.

- effective protection against mismatching
- easy tool-free operation, a wide range of coding options
- with B coding for use in automation of processes, such as lighting technology, for instance
- ready to install and use immediately
- quick replacement of defective units during ongoing operation

## Notes

## General safety information

1. Nur von Elektrofachkraft oder einer für die Tätigkeit elektrisch unterwiesenen Person (EUP nach DIN VDE 0105-100) anzuwenden!
2. Nicht unter Spannung/Last installieren!
3. Nur für bestimmungsgemäßen Gebrauch einsetzen!
4. Nationale Vorschriften/Normen/Richtlinien beachten!
5. Technische Daten der Produkte beachten!
6. Auf die richtige Polbelegung achten!
7. Keine beschädigten/verschmutzten Komponenten verwenden!
8. Leiterarten, -querschnitte, Abisolierlängen und Leitungsdurchmesser beachten!
9. Leiter bis zum Anschlag einführen!
10. Nur mit Verriegelungsklinke und Zugentlastung verwenden!
11. Originalzubehör verwenden!

**To be sold only with installation instructions!**

## Variants:

Other pole markings

Other versions (or variants) can be requested from WAGO Sales or configured at <https://configurator.wago.com/>.

## Electrical data

Ratings per	IEC/EN 60664-1		
Overvoltage category	III	III	II
Pollution degree	3	2	2
Nominal voltage	250 V	-	-
Rated impulse withstand voltage	4 kV	-	-
Rated current	16 A	-	-

## Ratings per IEC/EN – Notes

Rated current (note)	13 A for 3-pole load
----------------------	----------------------

## Approvals per

## UL 1977

Rated voltage	600 V
Rated current	14 A

## General information

Note on contact resistance	approx. 1 mΩ of contact resistance approx. 0.25 mΩ contact transition plug/socket
----------------------------	--

## Connection Data

Clamping units	3
Total number of potentials	3

## Connection 1

Connection technology	Push-in CAGE CLAMP®
Actuation type	Operating tool Push-in
Nominal cross-section	1.5 mm <sup>2</sup> / 16 AWG
Solid conductor	0.25 ... 1.5 mm <sup>2</sup> / 22 ... 16 AWG
Solid conductor; push-in termination	0.75 ... 1.5 mm <sup>2</sup> / 20 ... 16 AWG
Stranded conductor	0.25 ... 1 mm <sup>2</sup> / 22 ... 18 AWG
Fine-stranded conductor	0.25 ... 1.5 mm <sup>2</sup> / 22 ... 16 AWG
Fine-stranded conductor; with insulated ferrule	0.25 ... 0.75 mm <sup>2</sup> / 22 ... 20 AWG
Fine-stranded conductor; with uninsulated ferrule	0.25 ... 0.75 mm <sup>2</sup> / 22 ... 20 AWG
Fine-stranded conductor; with ferrule; push-in termination	0.75 mm <sup>2</sup> / 20 AWG
Strip length	9 mm / 0.35 inches
Pole number	3
Conductor entry direction to mating direction	0°

### Physical data

Pin spacing	4.4 mm / 0.173 inches
Width	15 mm / 0.591 inches
Height	11.7 mm / 0.461 inches
Depth	34.1 mm / 1.343 inches

### Mechanical data

Use	Control technology
Coding	B
Variable coding	No
Marking	3 2 1
Potential marking	3 2 1
Mating force of a plug-in connection	approx. 20 ... 70 N (depending on pole number)
Retention force of a plug-in connection	Locked: > 80 N
Unmating force of a plug-in connection	Unlocked: approx. 20 ... 70 N (depending on pole number)
Number of mating cycles	200, without resistive load
Protection type	IP20; IP40 when mated with strain relief housing

### Plug-in connection

Contact type (pluggable connector)	Male connector/plug
Connector (connection type)	for conductor
Mismating protection	Yes
Note on mismating protection	All WINSTA® components are 100% protected against mismating when: a.) plugging different numbers of poles b.) plugging while rotated 180 c.) plugging while laterally staggered d.) plugging one pole
Locking lever	Can be retrofitted
Locking of plug-in connection	Locking lever
Note on locking system	All connectors for mounted installations (snap-in versions for lighting fixtures or devices, all types of PCB and distribution connectors) are factory-equipped with locking levers to ensure plugs and sockets are securely locked. Additional locking levers are only required for flying leads (plug/socket).

### Material data

Note (material data)	<a href="#">Information on material specifications can be found here</a>
Color	gray
Cover color	gray
Material group	I
Insulation material (main housing)	Polyamide (PA66)
Flammability class per UL94	V0
Clamping spring material	Chrome-nickel spring steel (CrNi)
Contact material	Copper or copper alloy; surface-treated
Contact Plating	Tin
Fire load	0.079 MJ
Weight	3.6 g

### Environmental requirements

Processing temperature	-5 ... +40 °C
Continuous operating temperature	-35 ... +85 °C
Note on continuous operating temperature	Insulating parts for temperatures ≤ 105 °C

### Commercial data

Product Group	20 (Winsta)
PU (SPU)	50 pcs
Packaging type	Box
Country of origin	PL
GTIN	4055143499859
Customs tariff number	85366990990

### Product Classification

UNSPSC	39121402
eCl@ss 10.0	27-44-06-05
eCl@ss 9.0	27-44-06-05
ETIM 9.0	EC002560
ETIM 10.0	EC002560
ECCN	NO US CLASSIFICATION

### Environmental Product Compliance

RoHS Compliance Status	Compliant, No Exemption
------------------------	-------------------------

### Approvals / Certificates

#### General approvals



Approval	Standard	Certificate Name
CB DEKRA Certification B.V.	IEC 61984	NL-64351
CB DEKRA Certification B.V.	EN 61984	71-112993
cURus Underwriters Laboratories Inc.	UL 1977	E45171
KEMA/KEUR DEKRA Certification B.V.	EN 60320	2148952.04

#### Declarations of conformity and manufacturer's declarations

Approval	Standard	Certificate Name
EU-Declaration of Confor- mity WAGO GmbH & Co. KG	-	-
UK-Declaration of Confor- mity WAGO GmbH & Co. KG	-	-

### Approvals for marine applications



Approval	Standard	Certificate Name
DNV GL Det Norske Veritas, Ger- manischer Lloyd	-	TAE00001Z6
LR Lloyds Register	EN 61535	LR23317167TA
PRS Polski Rejestr Statków	-	TE/1096/880590/23

**Downloads**

**Environmental Product Compliance**

<b>Compliance Search</b>			
Environmental Product Compliance 890-253			↓

**Documentation**

<b>Bid Text</b>			
890-253	19.02.2019	xml 2.98 KB	↓
890-253	08.06.2015	doc 23.50 KB	↓

**CAD/CAE-Data**

<b>CAD data</b>	
2D/3D Models 890-253	↓

<b>CAE data</b>	
EPLAN Data Portal 890-253	↓
WSCAD Universe 890-253	↓
ZUKEN Portal 890-253	↓

**1 Compatible Products**

**1.1 System counterpart**

**1.1.1 Cable assembly**



**Item No.: 891-8993/105-103**  
pre-assembled connecting cable; Eca; Socket/open-ended; 3-pole; Cod. B; 1 m; 1,00 mm<sup>2</sup>; gray

**Item No.: 891-8993/005-103**  
pre-assembled interconnecting cable; Eca; Socket/plug; 3-pole; Cod. B; 1 m; 1,00 mm<sup>2</sup>; gray

**1.1.2 Distribution connector**



**Item No.: 890-1661**  
h-distribution connector; 3-pole; Cod. B; 1 input; 2 outputs; outputs on one side; 2 locking levers; gray



**Item No.: 890-1761**  
h-distribution connector; 3-pole; Cod. B; 1 input; 2 outputs; outputs on one side; 3 locking levers; for flying leads; gray

**1.1.3 Female connector/socket**



**Item No.: 890-743**  
Snap-in socket; 3-pole; Cod. B; 1,50 mm<sup>2</sup>; gray

**Item No.: 890-843/011-000**  
Socket for PCBs; angled; 3-pole; Cod. B; gray

**Item No.: 890-843**  
Socket for PCBs; straight; 3-pole; Cod. B; gray

**Item No.: 890-243**  
Socket; 3-pole; Cod. B; 1,50 mm<sup>2</sup>; gray

**1.2 Required Accessories**

**1.2.1 Locking system**

**1.2.1.1 Locking system**



**Item No.: 890-111**  
Locking lever; for flying leads; for tool operation; black

**Item No.: 890-131**  
Locking lever; for flying leads; for tool operation; white

**Item No.: 890-101**  
Locking lever; for manual operation; black

**Item No.: 890-121**  
Locking lever; for manual operation; white

**1.2.2 Strain relief**

**1.2.2.1 Strain relief housing**



**Item No.: 890-503**  
Strain relief housing; 3-pole; with locking clip; for 1 cable; 4.5 ... 10.0 mm; 37 mm; black

**Item No.: 890-513**  
Strain relief housing; 3-pole; with locking clip; for 1 cable; 4.5 ... 10.0 mm; 37 mm; white

**1.3 Optional Accessories**

**1.3.1 Cover**

**1.3.1.1 Cover**



**Item No.: 897-2001**  
Protective cap; Type1; for sockets and plugs; PVC; red

**1.3.2 Installation**

**1.3.2.1 Mounting accessories**



**Item No.: 890-310**  
Mounting carrier; 2- to 5-pole; for flying leads; black

**Item No.: 890-311**  
Mounting carrier; 2- to 5-pole; for flying leads; white

### 1.3.3 Tool

#### 1.3.3.1 Operating tool



**Item No.: 890-383**  
Operating tool; 3-way; green



**Item No.: 210-719**  
Operating tool; Blade: 2.5 x 0.4 mm; with a partially insulated shaft

### Installation Notes

#### Conductor termination

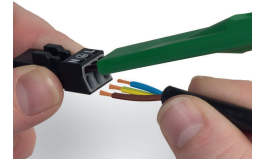
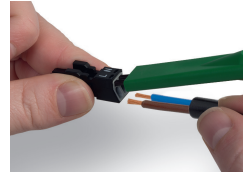
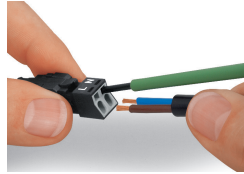

1. Strip length, outer insulation = 30 mm (2-pole), 37 mm (3-pole), 45 mm (4- and 5-pole)
2. Strip length = 9 mm
3. Extended ground conductor = 8 mm

To terminate fine-stranded conductors, open the clamping unit via screwdriver – 2.5 mm blade width – and insert a stripped conductor until it hits the backstop. Terminate solid conductors by simply pushing them in.

To terminate fine-stranded conductors, open clamping units via operating tool (890-382) and insert stripped conductors until they hit backstop. Terminate solid conductors by simply pushing them in.

To terminate fine-stranded conductors, open clamping units via operating tool (890-383) and insert stripped conductors until they hit backstop. Terminate solid conductors by simply pushing them in.

### Installation

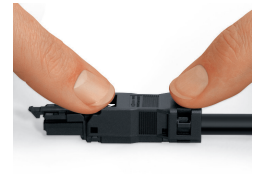
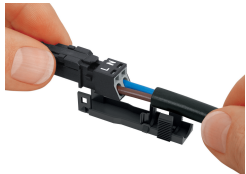

Latch the wired connector into the base of the strain relief housing.

Push down strain relief clamp by hand.

Push down strain relief clamp with 2.5 mm screwdriver alternately on both sides.

Latch the top of the strain relief housing.



The printed marking of the connector is clearly visible in the openings of the strain relief housing.

### Mismatching protection

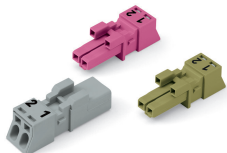

B-coded connectors with different colors can be plugged together.

B-coded connectors (shown in gray) not only differ in color, but also in their design, making them incompatible with other coded connectors.

**Important note:**  
Different colors and/or pole markings are used for circuit identification. Only connectors of the same color and same pole marking must be plugged together.

Subject to changes. Please also observe the further product documentation!

---

Current addresses can be found at: [www.wago.com](http://www.wago.com)