

Data Sheet | Item Number: 745-3801

Stackable PCB terminal block; 4 mm²; Pin spacing 5 mm; 1-pole; CAGE CLAMP®; gray

<https://www.wago.com/745-3801>

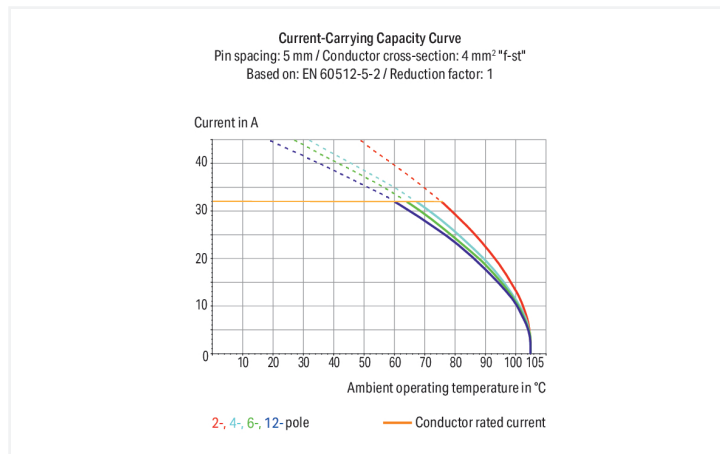

Color: ■ gray

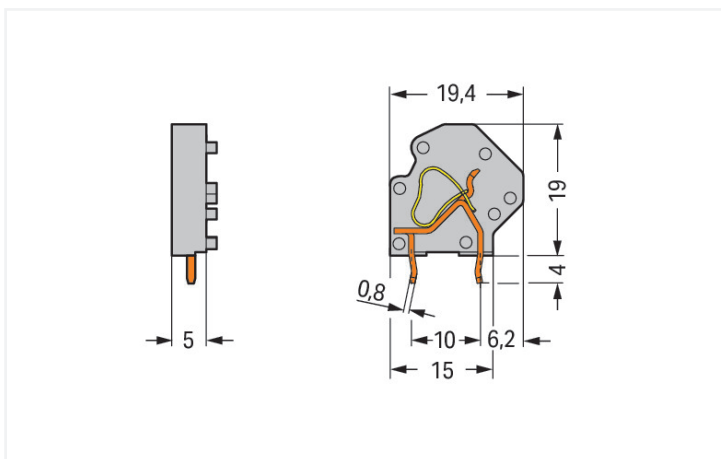

Dimensions in mm

PCB terminal block, 745 Series, with 5 mm pin spacing

Our PCB terminal block (item number 745-3801) ensures effortless electrical installations. You can count on trusted safety with these PCB terminal blocks, perfect for a wide range of applications when designing your devices. Conductors should only be connected to this PCB terminal block if their strip length is between 8 and 9 mm. Featuring one conductor terminal along with CAGE CLAMP®, this connector outperforms the competition. Our renowned universal connection known as CAGE CLAMP® leads the way when it comes to connection technology and electrical interconnections. The dimensions are (6.5 x 23 x 19.4) mm (width x height x depth). Depending on the conductor type, this PCB terminal block is designed for conductor cross sections ranging from 0.08 mm² to 4 mm².

The contact surface is coated with tin. An operating tool is used to operate this PCB terminal block. The PCB terminal block is designed for THT soldering. Insert the conductor into the board at a 45° angle.

Notes

Variants:

Versions for Ex e II and Ex i

Other colors

Other versions (or variants) can be requested from WAGO Sales or configured at <https://configurator.wago.com/>.

Electrical data

Ratings per		IEC/EN 60664-1			Approvals per		UL 1059		
Overvoltage category		III	III	II	Use group		B	C	D
Pollution degree		3	2	2	Rated voltage		300 V	-	300 V
Nominal voltage		320 V	320 V	630 V	Rated current		20 A	-	10 A
Rated impulse withstand voltage		4 kV	4 kV	4 kV					
Rated current		32 A	32 A	32 A					

Approvals per		CSA		
Use group		B	C	D
Rated voltage		300 V	-	300 V
Rated current		20 A	-	10 A

Connection Data

Clamping units	1
Total number of potentials	1
Number of connection types	1
Number of levels	1

Connection 1

Connection technology	CAGE CLAMP®
Actuation type	Operating tool
Solid conductor	0.08 ... 4 mm ² / 28 ... 12 AWG
Fine-stranded conductor	0.08 ... 4 mm ² / 28 ... 12 AWG
Fine-stranded conductor; with insulated ferrule	0.25 ... 2.5 mm ²
Fine-stranded conductor; with uninsulated ferrule	0.25 ... 2.5 mm ²
Strip length	8 ... 9 mm / 0.31 ... 0.35 inches
Conductor connection direction to PCB	45 °
Pole number	1

Physical data

Pin spacing	5 mm / 0.197 inches
Width	6.5 mm / 0.256 inches
Height	23 mm / 0.906 inches
Height from the surface	19 mm / 0.748 inches
Depth	19.4 mm / 0.764 inches
Solder pin length	4 mm
Solder pin dimensions	0.8 x 1.2 mm
Drilled hole diameter	1.5 ^(+0.1) mm

PCB contact

PCB contact	THT
Solder pin arrangement	within the terminal block (in-line)
Number of solder pins per potential	2

Material data

Note (material data)	Information on material specifications can be found here
Color	gray
Material group	I
Insulation material (main housing)	Polyamide (PA66)
Flammability class per UL94	V0
Clamping spring material	Chrome-nickel spring steel (CrNi)
Contact material	Electrolytic copper (E _{cu})
Contact Plating	Tin
Fire load	0.023 MJ
Weight	1.8 g

Environmental requirements

Limit temperature range	-60 ... +105 °C
-------------------------	-----------------

Commercial data

Product Group	4 (Printed Circuit Connectors)
PU (SPU)	200 (50) pcs
Packaging type	Box
Country of origin	PL
GTIN	4045454001193
Customs tariff number	85369010000

Product Classification

UNSPSC	39121409
eCl@ss 10.0	27-44-04-01
eCl@ss 9.0	27-44-04-01
ETIM 9.0	EC002643
ETIM 10.0	EC002643
ECCN	NO US CLASSIFICATION

Environmental Product Compliance

RoHS Compliance Status	Compliant, No Exemption
------------------------	-------------------------

Approvals / Certificates

General approvals



General approvals

cURus Underwriters Laboratories Inc.	UL 1059	E45172
--	---------	--------

Approval	Standard	Certificate Name
CCA DEKRA Certification B.V.	EN 60947	NTR NL-7095
CCA DEKRA Certification B.V.	EN 60947	71-112275
CSA DEKRA Certification B.V.	C22.2 No. 158	1604421

Declarations of conformity and manufacturer's declarations

Approval	Standard	Certificate Name
EU-Declaration of Confor- mity WAGO GmbH & Co. KG	-	-
UK-Declaration of Confor- mity WAGO GmbH & Co. KG	-	-

Downloads

Environmental Product Compliance

Compliance Search
Environmental Product Compliance 745-3801 

Documentation

Additional Information
Technical Section 03.04.2019 pdf 2027.26 KB 

CAD/CAE-Data

CAD data
2D/3D Models 745-3801 

CAE data
EPLAN Data Portal 745-3801 

ZUKEN Portal 745-3801 
--

PCB Design

Symbol and Footprint via SamacSys 745-3801 
--

Symbol and Footprint via Ultra Librarian 745-3801 

1 Compatible Products

1.1 Required Accessories

1.1.1 End plate

1.1.1.1 End plate



Item No.: 745-3100

End plate; 1.5 mm thick; snap-fit type; gray

1.1.1.2 Intermediate plate



Item No.: 745-3138

Spacer; for extending the pin spacing; 2.5 mm thick; gray

1.2 Optional Accessories

1.2.1 Marking

1.2.1.1 Marking strip



Item No.: 210-332/500-202

Marking strips; as a DIN A4 sheet; MARKED; 1-16 (160x); Height of marker strip: 3 mm; Strip length 182 mm; Horizontal marking; Self-adhesive; white



Item No.: 210-332/500-205

Marking strips; as a DIN A4 sheet; MARKED; 1-32 (80x); Height of marker strip: 3 mm; Strip length 182 mm; Horizontal marking; Self-adhesive; white



Item No.: 210-332/500-204

Marking strips; as a DIN A4 sheet; MARKED; 17-32 (160x); Height of marker strip: 3 mm; Strip length 182 mm; Horizontal marking; Self-adhesive; white



Item No.: 210-332/500-206

Marking strips; as a DIN A4 sheet; MARKED; 33-48 (160x); Height of marker strip: 3 mm; Strip length 182 mm; Horizontal marking; Self-adhesive; white

1.2.2 Test and measurement

1.2.2.1 Testing accessories



Item No.: 210-136

Test plug; 2 mm Ø; with 500 mm cable; red

1.2.3 Tool

1.2.3.1 Operating tool



Item No.: 210-658

Operating tool; Blade: 3.5 x 0.5 mm; with a partially insulated shaft; angled; short; multicoloured



Item No.: 210-720

Operating tool; Blade: 3.5 x 0.5 mm; with a partially insulated shaft; multicoloured



Item No.: 210-657

Operating tool; Blade: 3.5 x 0.5 mm; with a partially insulated shaft; short; multicoloured

Installation Notes

Installation

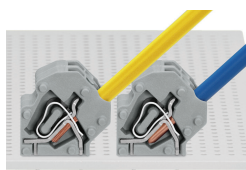

Saving space: two PCB terminal strips arranged in a row

Conductor termination

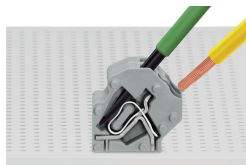

Inserting a conductor via 3.5 mm screwdriver.

Testing

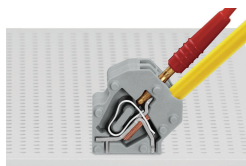

Testing with 2 mm Ø test plug.