

MOSFET – Power, Single N-Channel, STD Gate, SO8FL

80 V, 1.43 mΩ, 253 A

NTMFWS1D5N08X

Features

- Low Q_{RR} , Soft Recovery Body Diode
- Low $R_{DS(on)}$ to Minimize Conduction Losses
- Low Q_G and Capacitance to Minimize Driver Losses
- These Devices are Pb-Free, Halogen-Free/BFR-Free and are RoHS Compliant

Applications

- Synchronous Rectification (SR) in DC-DC and AC-DC
- Primary Switch in Isolated DC-DC Converter
- Motor Drives

MAXIMUM RATINGS ($T_J = 25\text{ }^\circ\text{C}$ unless otherwise noted)

Parameter	Symbol	Value	Unit
Drain-to-Source Voltage	V_{DSS}	80	V
Gate-to-Source Voltage	V_{GS}	± 20	V
Continuous Drain Current (Note 1)	$T_C = 25\text{ }^\circ\text{C}$	I_D	253 A
	$T_C = 100\text{ }^\circ\text{C}$		179
Power Dissipation (Note 1)	$T_C = 25\text{ }^\circ\text{C}$	P_D	194 W
Pulsed Drain Current	$T_C = 25\text{ }^\circ\text{C}$, $t_p = 100\text{ }\mu\text{s}$	I_{DM}	1071 A
Pulsed Source Current (Body Diode)		I_{SM}	1071
Operating Junction and Storage Temperature Range	T_J, T_{stg}	-55 to +175	$^\circ\text{C}$
Source Current (Body Diode)	I_S	303	A
Single Pulse Avalanche Energy ($I_{PK} = 67\text{ A}$) (Note 3)	E_{AS}	225	mJ
Lead Temperature for Soldering Purposes (1/8" from case for 10 s)	T_L	260	$^\circ\text{C}$

Stresses exceeding those listed in the Maximum Ratings table may damage the device. If any of these limits are exceeded, device functionality should not be assumed, damage may occur and reliability may be affected.

1. The entire application environment impacts the thermal resistance values shown. They are not constants and are only valid for the particular conditions noted.
2. Actual continuous current will be limited by thermal & electromechanical application board design.
3. E_{AS} of 225 mJ is based on started $T_J = 25\text{ }^\circ\text{C}$, $I_{AS} = 67\text{ A}$, $V_{DD} = 64\text{ V}$, $V_{GS} = 10\text{ V}$, 100% avalanche tested

$V_{(BR)DSS}$	$R_{DS(ON)}\text{ MAX}$	$I_D\text{ MAX}$
80 V	1.43 mΩ @ 10 V	253 A

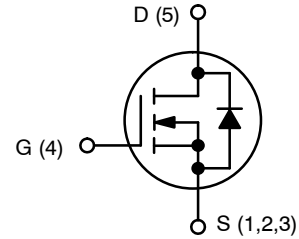

N-CHANNEL MOSFET

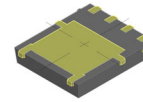

DFNW5
(SO8FL WF)
CASE 507BA

MARKING DIAGRAM

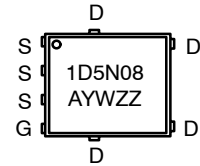

1D5N08 = Specific Device Code
A = Assembly Location
Y = Year
W = Work Week
ZZ = Lot Traceability

ORDERING INFORMATION

See detailed ordering, marking and shipping information on page 5 of this data sheet.

NTMFWS1D5N08X

THERMAL CHARACTERISTICS

Parameter	Symbol	Max	Unit
Thermal Resistance, Junction-to-Case	$R_{\theta JC}$	0.77	$^{\circ}C/W$
Thermal Resistance, Junction-to-Ambient (Notes 4, 5)	$R_{\theta JA}$	39	

- Surface-mounted on FR4 board using a 1 in², 1 oz. Cu pad.
- $R_{\theta JA}$ is determined by the user's board design.

ELECTRICAL CHARACTERISTICS ($T_J = 25^{\circ}C$ unless otherwise specified)

Parameter	Symbol	Test Condition	Min	Typ	Max	Unit
OFF CHARACTERISTICS						
Drain-to-Source Breakdown Voltage	$V_{(BR)DSS}$	$V_{GS} = 0 V, I_D = 1 mA$	80			V
Drain-to-Source Breakdown Voltage Temperature Coefficient	$\Delta V_{(BR)DSS} / \Delta T_J$	$I_D = 1 mA$, Referenced to $25^{\circ}C$		32		$mV/^{\circ}C$
Zero Gate Voltage Drain Current	I_{DSS}	$V_{DS} = 80 V, T_J = 25^{\circ}C$			1	μA
		$V_{DS} = 80 V, T_J = 125^{\circ}C$			250	
Gate-to-Source Leakage Current	I_{GSS}	$V_{DS} = 0 V, V_{GS} = 20 V$			100	nA

ON CHARACTERISTICS

Drain-to-Source On Resistance	$R_{DS(on)}$	$V_{GS} = 10 V, I_D = 50 A$		1.24	1.43	$m\Omega$
		$V_{GS} = 6 V, I_D = 33 A$		1.9	2.5	
Gate Threshold Voltage	$V_{GS(TH)}$	$V_{GS} = V_{DS}, I_D = 330 \mu A$	2.4		3.6	V
Gate Threshold Voltage Temperature Coefficient	$\Delta V_{GS(TH)} / \Delta T_J$	$V_{GS} = V_{DS}, I_D = 330 \mu A$		-7.32		$mV/^{\circ}C$
Forward Transconductance	g_{FS}	$V_{DS} = 5 V, I_D = 50 A$		176		S

CHARGES, CAPACITANCES & GATE RESISTANCE

Input Capacitance	C_{ISS}	$V_{GS} = 0 V, V_{DS} = 40 V, f = 1 MHz$		5880		pF	
Output Capacitance	C_{OSS}			1690			
Reverse Transfer Capacitance	C_{RSS}			25			
Output Charge	Q_{OSS}	$V_{GS} = 10 V, V_{DD} = 40 V; I_D = 50 A$		121		nC	
Total Gate Charge	$Q_{G(TOT)}$		$V_{GS} = 6 V, V_{DD} = 40 V; I_D = 50 A$		51		
Total Gate Charge	$Q_{G(TOT)}$				83		
Threshold Gate Charge	$Q_{G(TH)}$				18		
Gate-to-Source Charge	Q_{GS}				27		
Gate-to-Drain Charge	Q_{GD}				13		
Gate Plateau Voltage	V_{GP}				4.6		V
Gate Resistance	R_G		$f = 1 MHz$		0.6		

SWITCHING CHARACTERISTICS

Turn-On Delay Time	$t_{d(ON)}$	Resistive Load, $V_{GS} = 0/10 V, V_{DD} = 40 V,$ $I_D = 50 A, R_G = 2.5 \Omega$		32		ns
Rise Time	t_r			9		
Turn-Off Delay Time	$t_{d(OFF)}$			48		
Fall Time	t_f			7.8		

SOURCE-TO-DRAIN DIODE CHARACTERISTICS

Forward Diode Voltage	V_{SD}	$V_{GS} = 0 V, I_S = 50 A, T_J = 25^{\circ}C$		0.81	1.2	V
		$V_{GS} = 0 V, I_S = 50 A, T_J = 125^{\circ}C$		0.66		
Reverse Recovery Time	t_{RR}	$V_{GS} = 0 V, I_S = 50 A,$ $di/dt = 1000 A/\mu s, V_{DD} = 40 V$		32		ns
Charge Time	t_a			19		
Discharge Time	t_b			13		
Reverse Recovery Charge	Q_{RR}			224		

Product parametric performance is indicated in the Electrical Characteristics for the listed test conditions, unless otherwise noted. Product performance may not be indicated by the Electrical Characteristics if operated under different conditions.

NTMFWS1D5N08X

TYPICAL CHARACTERISTICS

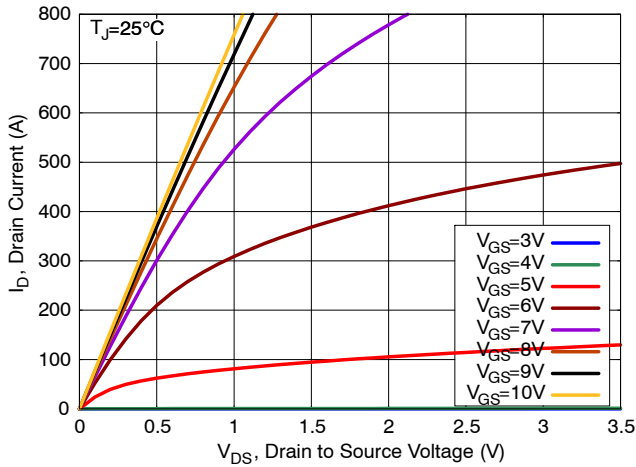

Figure 1. On-Region Characteristics

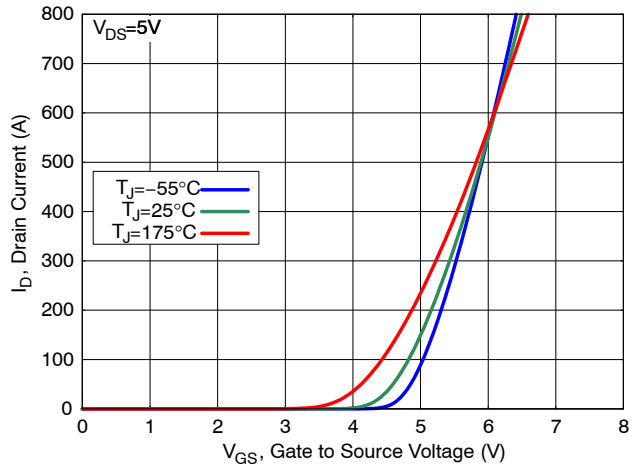

Figure 2. Transfer Characteristics

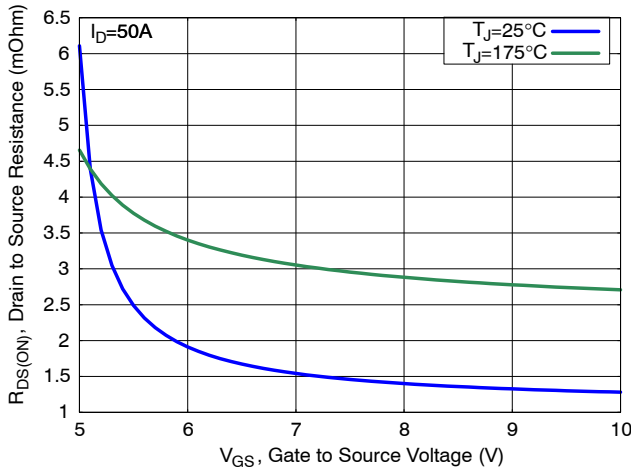

Figure 3. On-Resistance vs. Gate Voltage

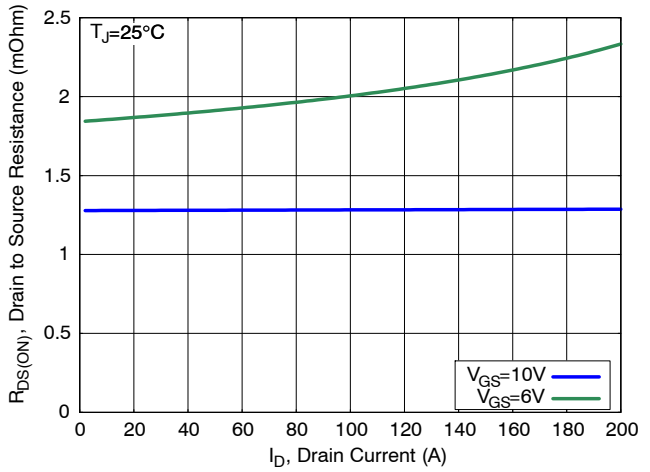

Figure 4. On-Resistance vs. Drain Current

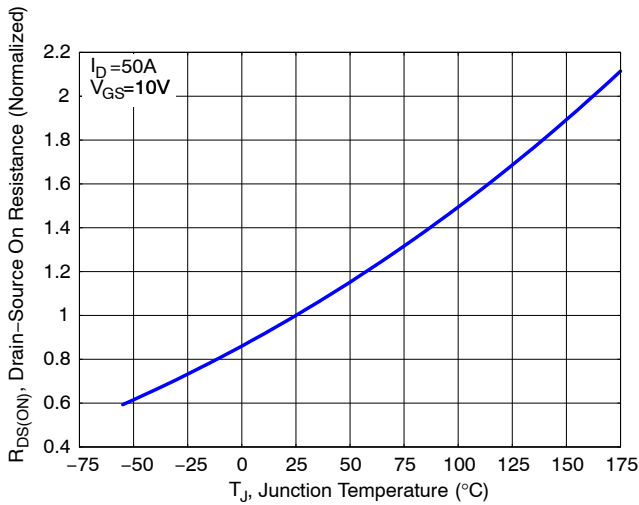

Figure 5. Normalized On-Resistance vs. Junction Temperature

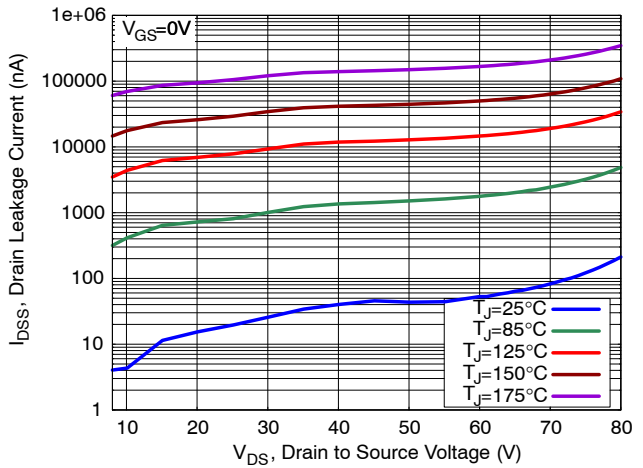

Figure 6. Drain Leakage Current vs. Drain Voltage

NTMFWS1D5N08X

TYPICAL CHARACTERISTICS

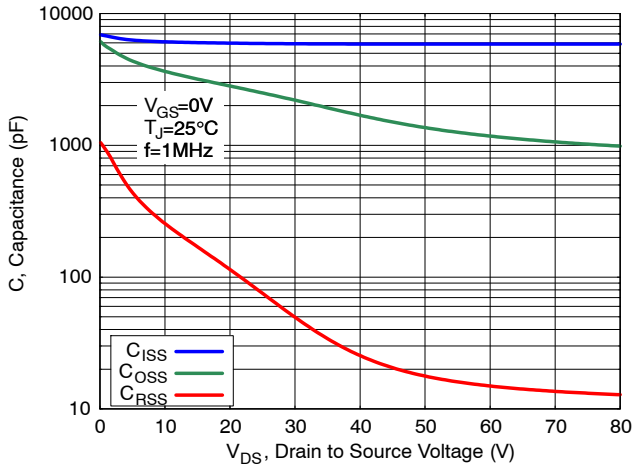

Figure 7. Capacitance Characteristics

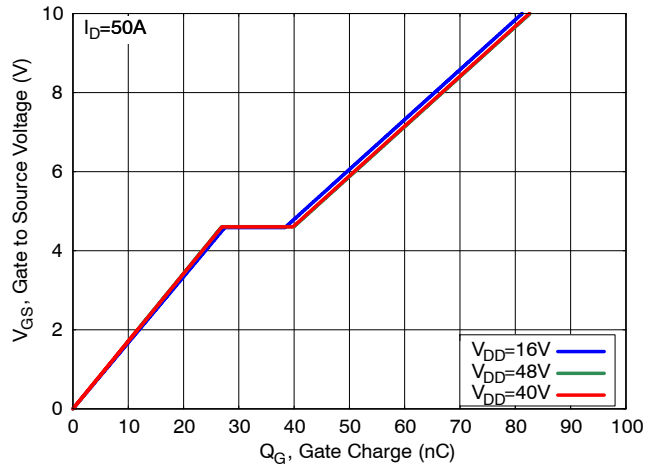

Figure 8. Gate Charge Characteristics

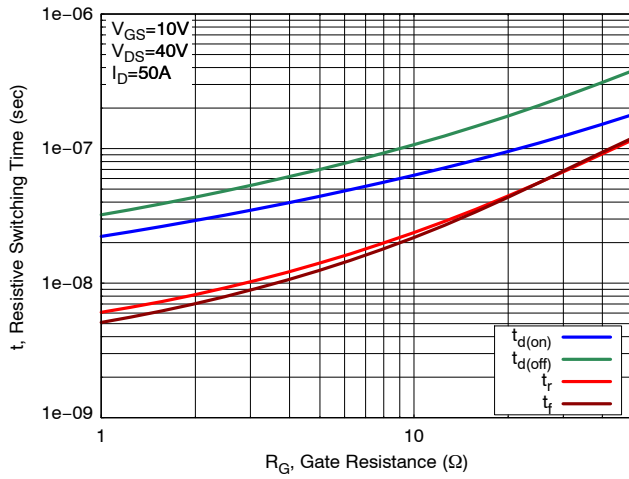

Figure 9. Resistive Switching Time Variation vs. Gate Resistance

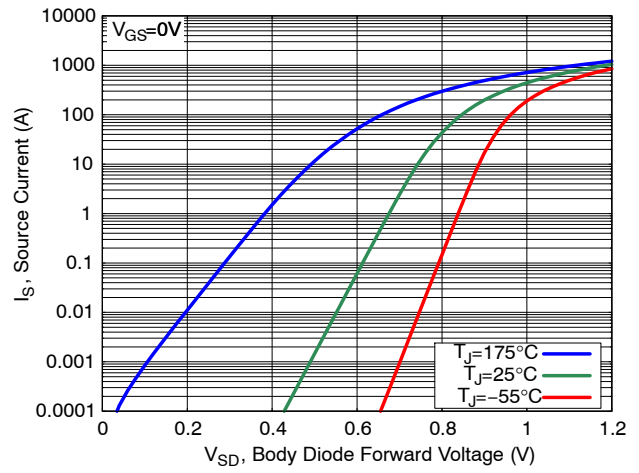

Figure 10. Diode Forward Characteristics

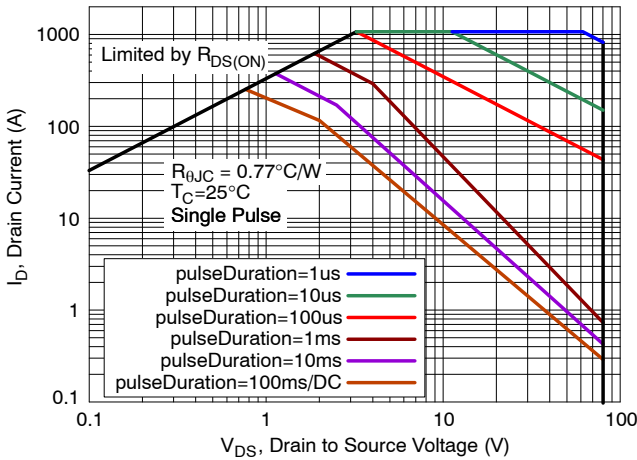

Figure 11. Safe Operating Area (SOA)

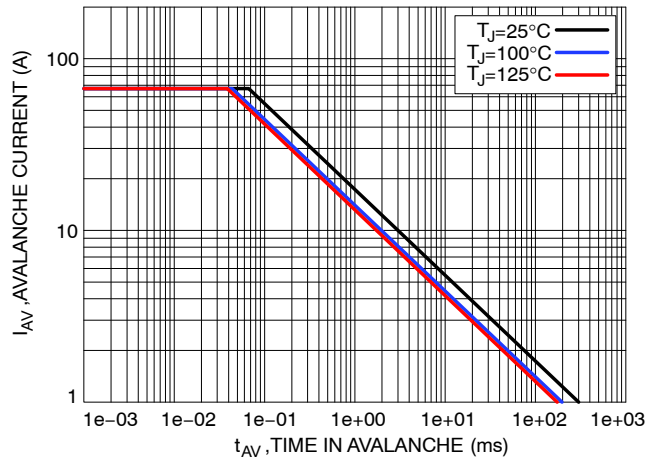

Figure 12. Avalanche Current vs. Pulse Time (UIS)

NTMFWS1D5N08X

TYPICAL CHARACTERISTICS

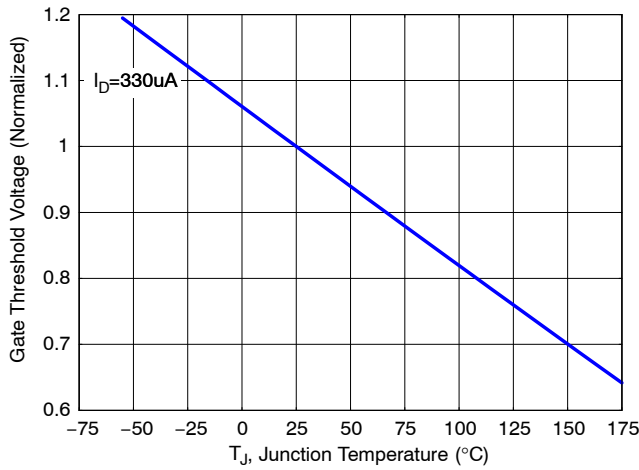

Figure 13. Gate Threshold Voltage vs. Junction Temperature

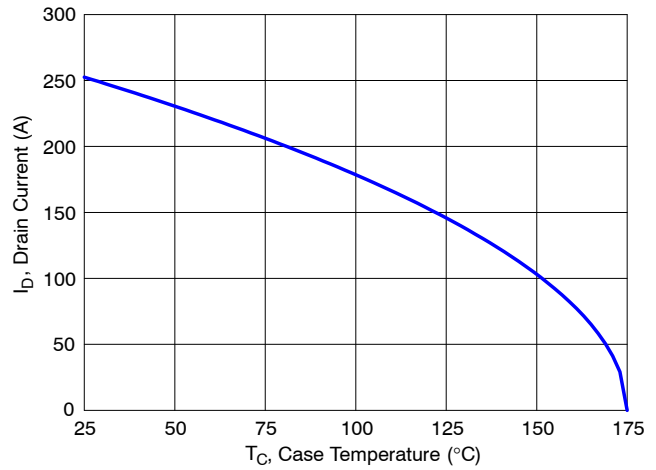

Figure 14. Maximum Current vs. Case Temperature

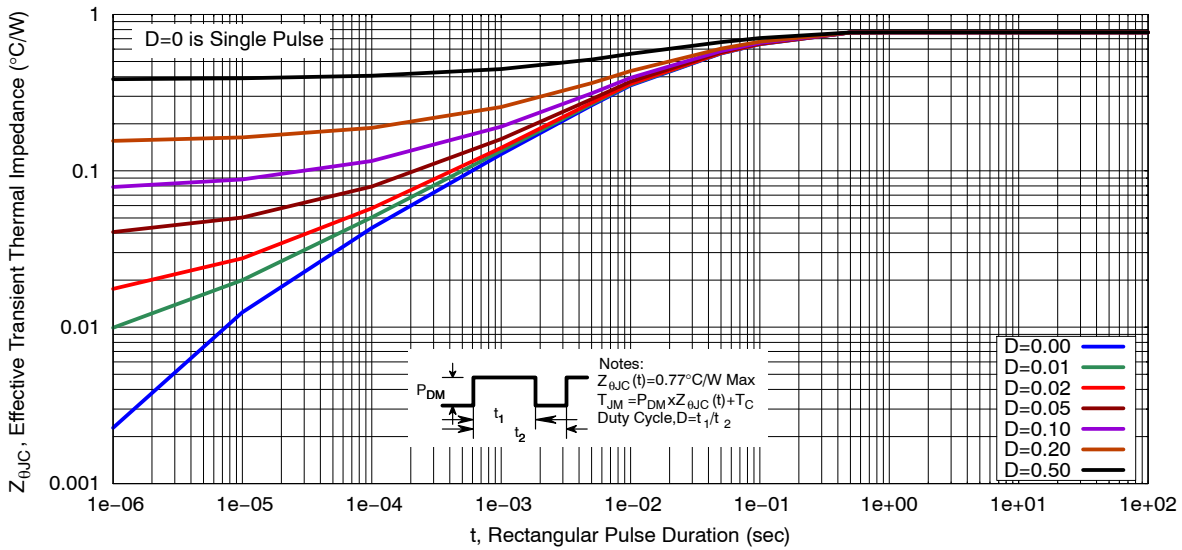

Figure 15. Transient Thermal Response

DEVICE ORDERING INFORMATION

Device	Marking	Package	Shipping [†]
NTMFWS1D5N08XT1G	1D5N08	DFNW5 (Pb-Free)	1500 / Tape & Reel

[†]For information on tape and reel specifications, including part orientation and tape sizes, please refer to our Tape and Reel Packaging Specifications Brochure, BRD8011/D.

NTMFWS1D5N08X

REVISION HISTORY

Revision	Description of Changes	Date
0	Initial version release.	1/11/2023
1	Final version release.	4/18/2023
2	Update the package case outline (issue A to B).	7/19/2024
3	Update the table value of Drain-to-Source Breakdown Voltage Temperature Coefficient, Switching characteristics, and Figure 9.	1/9/2025
4	Change thermal characteristic header to Max and update table value of Switching characteristics and Figure 9.	8/11/2025

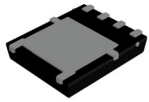

DFNW5 4.90x5.90x1.00, 1.27P
CASE 507BA
ISSUE C

DATE 19 SEP 2024

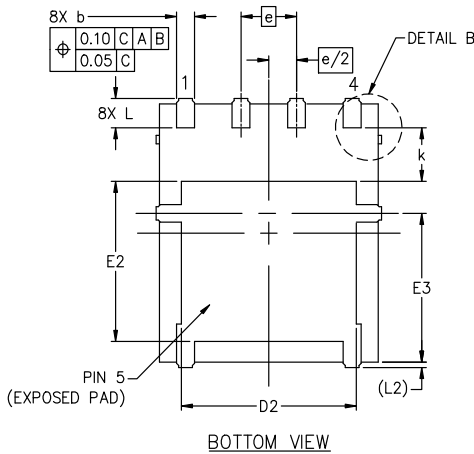
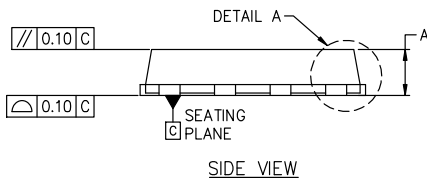
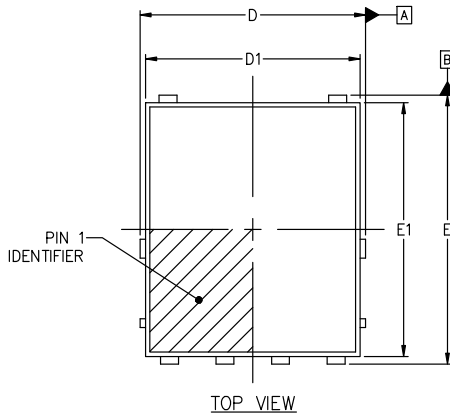

NOTES:

1. DIMENSIONING AND TOLERANCING CONFORM TO ASME Y14.5M-2018.
2. ALL DIMENSIONS ARE IN MILLIMETERS.
3. DIMENSIONS D1 AND E1 DO NOT INCLUDE MOLD FLASH, PROTRUSIONS, OR GATE BURRS.
4. THIS PACKAGE CONTAINS WETTABLE FLANK DESIGN FEATURES TO AID IN FILLET FORMATION ON THE LEADS DURING MOUNTING.

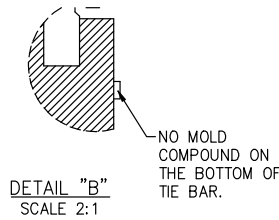
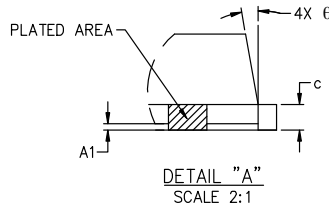

DIM	MILLIMETERS		
	MIN	NOM	MAX
A	0.90	1.00	1.10
A1	0.00	---	0.05
b	0.33	0.41	0.51
c	0.23	0.28	0.33
D	5.00	5.15	5.30
D1	4.70	4.90	5.10
D2	3.80	4.00	4.20
E	6.00	6.15	6.30
E1	5.70	5.90	6.10
E2	3.45	3.65	3.85
E3	3.00	3.40	3.80
e	1.27 BSC		
k	1.20	1.35	1.50
L	0.51	0.57	0.71
L2	0.15 REF.		
theta	0°	6°	12°

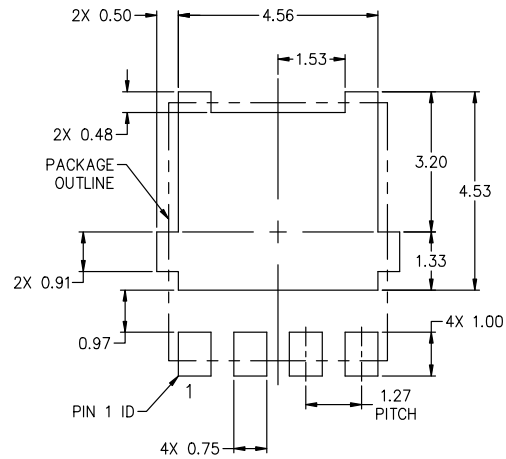

RECOMMENDED MOUNTING FOOTPRINT*
*FOR ADDITIONAL INFORMATION ON OUR Pb-FREE STRATEGY AND SOLDERING DETAILS, PLEASE DOWNLOAD THE ONSEMI SOLDERING AND MOUNTING TECHNIQUES REFERENCE MANUAL, SOLDERM/D.

GENERIC MARKING DIAGRAM*



XXXXXX = Specific Device Code
A = Assembly Location
Y = Year
W = Work Week
ZZ = Lot Traceability

*This information is generic. Please refer to device data sheet for actual part marking. Pb-Free indicator, "G" or microdot "•", may or may not be present. Some products may not follow the Generic Marking.

DOCUMENT NUMBER:	98AON26450H	Electronic versions are uncontrolled except when accessed directly from the Document Repository. Printed versions are uncontrolled except when stamped "CONTROLLED COPY" in red.
DESCRIPTION:	DFNW5 4.90x5.90x1.00, 1.27P	PAGE 1 OF 1

onsemi and ONSEMI are trademarks of Semiconductor Components Industries, LLC dba onsemi or its subsidiaries in the United States and/or other countries. onsemi reserves the right to make changes without further notice to any products herein. onsemi makes no warranty, representation or guarantee regarding the suitability of its products for any particular purpose, nor does onsemi assume any liability arising out of the application or use of any product or circuit, and specifically disclaims any and all liability, including without limitation special, consequential or incidental damages. onsemi does not convey any license under its patent rights nor the rights of others.

onsemi, **Onsemi**, and other names, marks, and brands are registered and/or common law trademarks of Semiconductor Components Industries, LLC dba "**onsemi**" or its affiliates and/or subsidiaries in the United States and/or other countries. **onsemi** owns the rights to a number of patents, trademarks, copyrights, trade secrets, and other intellectual property. A listing of **onsemi**'s product/patent coverage may be accessed at www.onsemi.com/site/pdf/Patent-Marking.pdf. **onsemi** reserves the right to make changes at any time to any products or information herein, without notice. The information herein is provided "as-is" and **onsemi** makes no warranty, representation or guarantee regarding the accuracy of the information, product features, availability, functionality, or suitability of its products for any particular purpose, nor does **onsemi** assume any liability arising out of the application or use of any product or circuit, and specifically disclaims any and all liability, including without limitation special, consequential or incidental damages. Buyer is responsible for its products and applications using **onsemi** products, including compliance with all laws, regulations and safety requirements or standards, regardless of any support or applications information provided by **onsemi**. "Typical" parameters which may be provided in **onsemi** data sheets and/or specifications can and do vary in different applications and actual performance may vary over time. All operating parameters, including "Typicals" must be validated for each customer application by customer's technical experts. **onsemi** does not convey any license under any of its intellectual property rights nor the rights of others. **onsemi** products are not designed, intended, or authorized for use as a critical component in life support systems or any FDA Class 3 medical devices or medical devices with a same or similar classification in a foreign jurisdiction or any devices intended for implantation in the human body. Should Buyer purchase or use **onsemi** products for any such unintended or unauthorized application, Buyer shall indemnify and hold **onsemi** and its officers, employees, subsidiaries, affiliates, and distributors harmless against all claims, costs, damages, and expenses, and reasonable attorney fees arising out of, directly or indirectly, any claim of personal injury or death associated with such unintended or unauthorized use, even if such claim alleges that **onsemi** was negligent regarding the design or manufacture of the part. **onsemi** is an Equal Opportunity/Affirmative Action Employer. This literature is subject to all applicable copyright laws and is not for resale in any manner.

ADDITIONAL INFORMATION

TECHNICAL PUBLICATIONS:

Technical Library: www.onsemi.com/design/resources/technical-documentation
onsemi Website: www.onsemi.com

ONLINE SUPPORT: www.onsemi.com/support

For additional information, please contact your local Sales Representative at www.onsemi.com/support/sales

