

### Features

- Constant Voltage + Constant Current mode output
- Metal housing with class I design
- Built-in active PFC function
- Class 2 power unit
- IP67 / IP65 rating for indoor or outdoor installations
- Function options: output adjustable via potentiometer; 3 in 1 dimming; Timer dimming
- Typical lifetime > 62000 hours
- 7 years warranty

### Applications

- LED street lighting
- LED high-bay lighting
- Parking space lighting
- LED fishing lamp
- LED greenhouse lighting
- Type "HL" for use in Class I , Division 2 hazardous (Classified) location.

### GTIN CODE

MW Search: <https://www.meanwell.com/serviceGTIN.aspx>

### Description

HLG-80H series is a 80W AC/DC LED driver featuring the dual mode constant voltage and constant current output. HLG-80H operates from 90 ~ 305VAC and offers models with different rated voltage ranging between 12V and 54V. Thanks to the high efficiency up to 91%, with the fanless design, the entire series is able to operate for -40°C ~ +80°C case temperature under free air convection. The design of metal housing and IP67/IP65 ingress protection level allows this series to fit both indoor and outdoor applications. HLG-80H is equipped with various function options, such as dimming methodologies, so as to provide the optimal design flexibility for LED lighting system.

### Model Encoding

**HLG - 80H - 15 A**

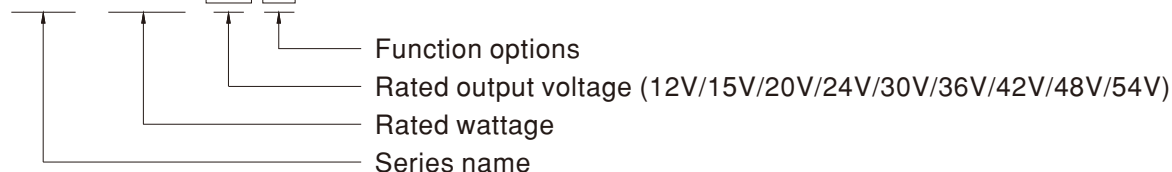

| Type  | IP Level | Function  | Note       |
|-------|----------|---|------------|
| Blank | IP67     | Io and Vo fixed   | In Stock   |
| A     | IP65     | Io and Vo adjustable through built-in potentiometer   | In Stock   |
| B     | IP67     | 3 in 1 dimming function (1~10VDC, 10V PWM signal and resistance)  | In Stock   |
| AB    | IP65     | Io adjustable through built-in potentiometer & 3 in 1 dimming function (1~10Vdc, 10V PWM signal and resistance) | In Stock   |
| BL    | IP66     | B-Type with junction box. UL8750 LISTED. Contact MEAN WELL for details  | By request |
| D     | IP67     | Timer dimming function, contact MEAN WELL for details(safety pending).  | By request |

**SPECIFICATION**

| MODEL                   | HLG-80H-12   | HLG-80H-15   | HLG-80H-20 | HLG-80H-24 | HLG-80H-30  | HLG-80H-36  | HLG-80H-42  | HLG-80H-48   | HLG-80H-54  |            |  |
|-------------------------|--|--|------------|------------|-------------|-------------|-------------|--------------|-------------|------------|--|
| OUTPUT                  | DC VOLTAGE   | 12V  | 15V        | 20V        | 24V         | 30V         | 36V         | 42V          | 48V         | 54V        |  |
|                         | CONSTANT CURRENT REGION Note.4   | 7.2 ~ 12V  | 9 ~ 15V    | 12 ~ 20V   | 14.4 ~ 24V  | 18 ~ 30V    | 21.6 ~ 36V  | 25.2 ~ 42V   | 28.8 ~ 48V  | 32.4 ~ 54V |  |
|                         | RATED CURRENT  | 5A   | 5A         | 4A         | 3.4A        | 2.7A        | 2.3A        | 1.95A        | 1.7A        | 1.5A       |  |
|                         | RATED POWER  | 60W  | 75W        | 80W        | 81.6W       | 81W         | 82.8W       | 81.9W        | 81.6W       | 81W        |  |
|                         | RIPPLE & NOISE (max.) Note.2   | 150mVp-p   | 150mVp-p   | 150mVp-p   | 150mVp-p    | 200mVp-p    | 200mVp-p    | 200mVp-p     | 200mVp-p    | 200mVp-p   |  |
|                         | VOLTAGE ADJ. RANGE   | Adjustable for A-Type only (via built-in potentiometer)  |            |            |             |             |             |              |             |            |  |
|                         |  | 10.8 ~ 13.5V   | 13.5 ~ 17V | 17 ~ 22V   | 22 ~ 27V    | 27 ~ 33V    | 33 ~ 40V    | 38 ~ 46V     | 43 ~ 53V    | 49 ~ 58V   |  |
|                         | CURRENT ADJ. RANGE   | Adjustable for A/AB-Type only (via built-in potentiometer)   |            |            |             |             |             |              |             |            |  |
|                         |  | 3 ~ 5A   | 3 ~ 5A     | 2.4 ~ 4A   | 2.04 ~ 3.4A | 1.62 ~ 2.7A | 1.38 ~ 2.3A | 1.17 ~ 1.95A | 1.02 ~ 1.7A | 0.9 ~ 1.5A |  |
|                         | VOLTAGE TOLERANCE Note.3   | ± 2.5%   | ± 2.0%     | ± 1.0%     | ± 1.0%      | ± 1.0%      | ± 1.0%      | ± 1.0%       | ± 1.0%      | ± 1.0%     |  |
| LINE REGULATION         | ± 0.5%   | ± 0.5%   | ± 0.5%     | ± 0.5%     | ± 0.5%      | ± 0.5%      | ± 0.5%      | ± 0.5%       | ± 0.5%      |            |  |
| LOAD REGULATION         | ± 2.0%   | ± 1.5%   | ± 1.0%     | ± 0.5%     | ± 0.5%      | ± 0.5%      | ± 0.5%      | ± 0.5%       | ± 0.5%      |            |  |
| SETUP, RISE TIME Note.6 | 1200ms,200ms/115VAC 500ms,200ms/230VAC   |  |            |            |             |             |             |              |             |            |  |
| HOLD UP TIME (Typ.)     | 16ms at full load 230VAC /115VAC   |  |            |            |             |             |             |              |             |            |  |
| INPUT                   | VOLTAGE RANGE Note.5   | 90 ~ 305VAC 127 ~ 431VDC<br>(Please refer to "STATIC CHARACTERISTIC" section)  |            |            |             |             |             |              |             |            |  |
|                         | FREQUENCY RANGE  | 47 ~ 63Hz  |            |            |             |             |             |              |             |            |  |
|                         | POWER FACTOR (Typ.)  | PF ≥ 0.96/115VAC, PF ≥ 0.96/230VAC, PF ≥ 0.94/277VAC @ full load<br>(Please refer to "POWER FACTOR (PF) CHARACTERISTIC" section)   |            |            |             |             |             |              |             |            |  |
|                         | TOTAL HARMONIC DISTORTION  | THD < 20% (@ load ≥ 60% / 115VAC, 230VAC; @ load ≥ 75% / 277VAC)<br>(Please refer to "TOTAL HARMONIC DISTORTION (THD)" section)  |            |            |             |             |             |              |             |            |  |
|                         | EFFICIENCY (Typ.)  | 88%  | 89%        | 90%        | 90.5%       | 91%         | 91%         | 91%          | 91%         | 91%        |  |
|                         | AC CURRENT (Typ.)  | 0.85A / 115VAC 0.425A / 230VAC 0.4A / 277VAC   |            |            |             |             |             |              |             |            |  |
|                         | INRUSH CURRENT (Typ.)  | COLD START 70A(t <sub>width</sub> =485μs measured at 50% I <sub>peak</sub> ) at 230VAC; Per NEMA 410   |            |            |             |             |             |              |             |            |  |
|                         | MAX. No. of PSUs on 16A CIRCUIT BREAKER  | 3 units (circuit breaker of type B) / 6 units (circuit breaker of type C) at 230VAC  |            |            |             |             |             |              |             |            |  |
| LEAKAGE CURRENT         | <0.75mA / 277VAC   |  |            |            |             |             |             |              |             |            |  |
| PROTECTION              | OVER CURRENT   | 95 ~ 108%<br>Constant current limiting, recovers automatically after fault condition is removed  |            |            |             |             |             |              |             |            |  |
|                         | SHORT CIRCUIT  | Hiccup mode, recovers automatically after fault condition is removed   |            |            |             |             |             |              |             |            |  |
|                         | OVER VOLTAGE   | 14 ~ 17V   | 18 ~ 24V   | 23 ~ 30V   | 28 ~ 35V    | 35 ~ 43V    | 41 ~ 49V    | 48 ~ 58V     | 54 ~ 63V    | 59 ~ 68V   |  |
|                         | OVER TEMPERATURE   | Shut down o/p voltage, re-power on to recover  |            |            |             |             |             |              |             |            |  |
| ENVIRONMENT             | WORKING TEMP.  | T <sub>case</sub> = -40 ~ +80°C (Please refer to "OUTPUT LOAD vs TEMPERATURE" section)   |            |            |             |             |             |              |             |            |  |
|                         | MAX. CASE TEMP.  | T <sub>case</sub> = +80°C  |            |            |             |             |             |              |             |            |  |
|                         | WORKING HUMIDITY   | 20 ~ 95% RH non-condensing   |            |            |             |             |             |              |             |            |  |
|                         | STORAGE TEMP., HUMIDITY  | -40 ~ +80°C, 10 ~ 95% RH   |            |            |             |             |             |              |             |            |  |
|                         | TEMP. COEFFICIENT  | ± 0.03%/°C (0 ~ 60°C)  |            |            |             |             |             |              |             |            |  |
|                         | VIBRATION  | 10 ~ 500Hz, 5G 12min./1cycle, period for 72min. each along X, Y, Z axes  |            |            |             |             |             |              |             |            |  |
| SAFETY & EMC            | SAFETY STANDARDS Note.8  | UL8750(type"HL"), CSA C22.2 No. 250.0-08, UL8750 LISTED for HLG-80H-□BL; BS EN/EN/AS/NZS 61347-1, BS EN/EN/AS/NZS 61347-2-13, J61347-1, J61347-2-13(except for BL-type), GB/T19510.1, independent, GB/T19510.213, EAC TP TC 004, BIS IS15885(for 36A,54A only), IP65 or IP67, KC61347-1, KC61347-2-13(except for AB, BL-type) approved |            |            |             |             |             |              |             |            |  |
|                         | WITHSTAND VOLTAGE  | I/P-O/P: 3.75KVAC I/P-FG: 2KVAC O/P-FG: 1.5KVAC  |            |            |             |             |             |              |             |            |  |
|                         | ISOLATION RESISTANCE   | I/P-O/P, I/P-FG, O/P-FG: 100M Ohms / 500VDC / 25°C / 70% RH  |            |            |             |             |             |              |             |            |  |
|                         | EMC EMISSION Note.8  | Compliance to BS EN/EN55015, BS EN/EN61000-3-2 Class C (@ load ≥ 60%); BS EN/EN61000-3-3, GB/T 17743, GB17625.1, KS C 9815, KS C 9547 (except for BL type), EAC TP TC 020  |            |            |             |             |             |              |             |            |  |
| EMC IMMUNITY            | Compliance to BS EN/EN61000-4-2, 3, 4, 5, 6, 8, 11, BS EN/EN61547, light industry level (surge immunity Line-Earth 4KV, Line-Line 2KV), KS C 9815, KS C 9547 (except for BL type), EAC TP TC 020   |  |            |            |             |             |             |              |             |            |  |
| OTHERS                  | MTBF   | 2992.9K hrs min. Telcordia SR-332 (Bellcore); 289.1K hrs min. MIL-HDBK-217F (25°C)   |            |            |             |             |             |              |             |            |  |
|                         | DIMENSION  | 195.6*61.5*38.8mm (L*W*H)  |            |            |             |             |             |              |             |            |  |
|                         | PACKING  | 0.84Kg; 16pcs/14.4Kg/0.54CUFT  |            |            |             |             |             |              |             |            |  |
| NOTE                    | <p>1. All parameters NOT specially mentioned are measured at 230VAC input, rated current and 25°C of ambient temperature.</p> <p>2. Ripple &amp; noise are measured at 20MHz of bandwidth by using a 12" twisted pair-wire terminated with a 0.1uf &amp; 47uf parallel capacitor.</p> <p>3. Tolerance : includes set up tolerance, line regulation and load regulation.</p> <p>4. Please refer to "DRIVING METHODS OF LED MODULE".</p> <p>5. De-rating may be needed under low input voltages. Please refer to "STATIC CHARACTERISTIC" sections for details.</p> <p>6. Length of set up time is measured at first cold start. Turning ON/OFF the driver may lead to increase of the set up time.</p> <p>7. The driver is considered as a component that will be operated in combination with final equipment. Since EMC performance will be affected by the complete installation, the final equipment manufacturers must re-qualify EMC Directive on the complete installation again.<br/>(as available on <a href="https://www.meanwell.com/Upload/PDF/EMI_statement_en.pdf">https://www.meanwell.com/Upload/PDF/EMI_statement_en.pdf</a>)</p> <p>8. To fulfill requirements of the latest ErP regulation for lighting fixtures, this LED driver can only be used behind a switch without permanently connected to the mains.</p> <p>9. This series meets the typical life expectancy of &gt;62,000 hours of operation when T<sub>case</sub>, particularly (T<sub>c</sub>) point (or TMP, per DLC), is about 75°C or less.</p> <p>10. Please refer to the warranty statement on MEAN WELL's website at <a href="http://www.meanwell.com">http://www.meanwell.com</a>.</p> <p>11. The ambient temperature derating of 3.5°C/1000m with fanless models and of 5°C/1000m with fan models for operating altitude higher than 2000m(6500ft).</p> <p>12. For any application note and IP water proof function installation caution, please refer our user manual before using.<br/><a href="https://www.meanwell.com/Upload/PDF/LED_EN.pdf">https://www.meanwell.com/Upload/PDF/LED_EN.pdf</a></p> <p>13. For A/AB type need to consider build in using to comply with Type HL application.</p> <p>14. Products sourced from the Americas regions may only have the UL, CE and UKCA logos. Please contact your MEAN WELL sales for more information.</p> |  |            |            |             |             |             |              |             |            |  |

## ■ BLOCK DIAGRAM

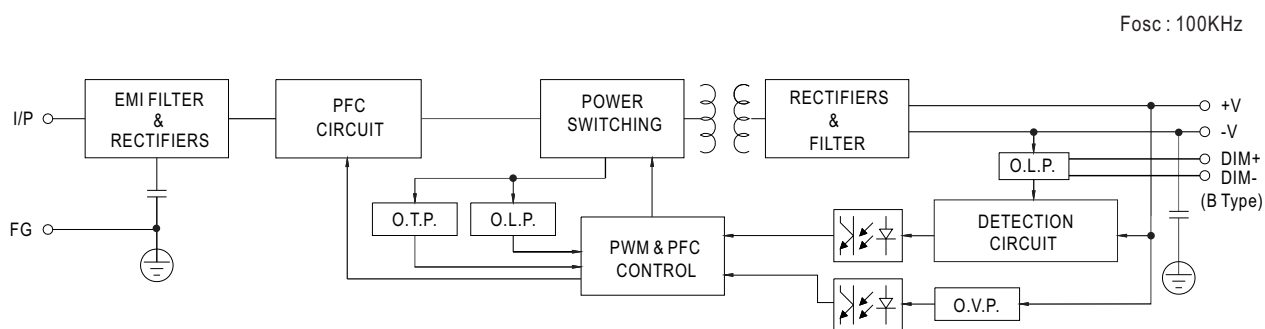

## ■ DRIVING METHODS OF LED MODULE

※ This series is able to work in either Constant Current mode (a direct drive way) or Constant Voltage mode (usually through additional DC/DC driver) to drive the LEDs.

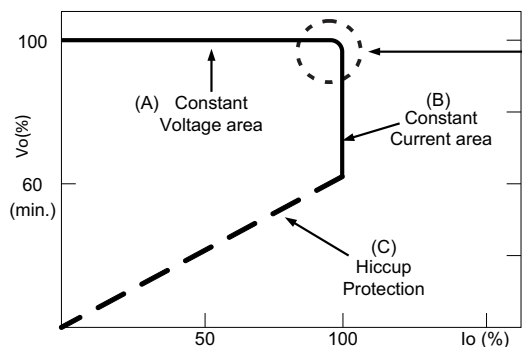

Typical output current normalized by rated current (%)

In the constant current region, the highest voltage at the output of the driver depends on the configuration of the end systems.

Should there be any compatibility issues, please contact MEAN WELL.

## DIMMING OPERATION

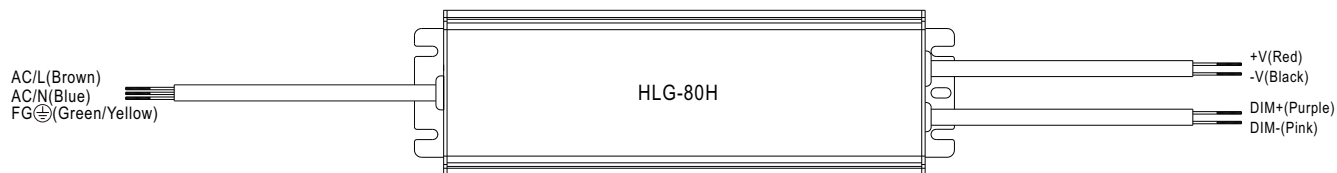

### ※ 3 in 1 dimming function (for B/AB-Type)

- Output constant current level can be adjusted by applying one of the three methodologies between DIM+ and DIM-: 1 ~ 10VDC, or 10V PWM signal or resistance.
- Direct connecting to LEDs is suggested. It is not suitable to be used with additional drivers.
- Dimming source current from power supply: 100 $\mu$ A (typ.)

#### ◎ Applying additive 1 ~ 10VDC

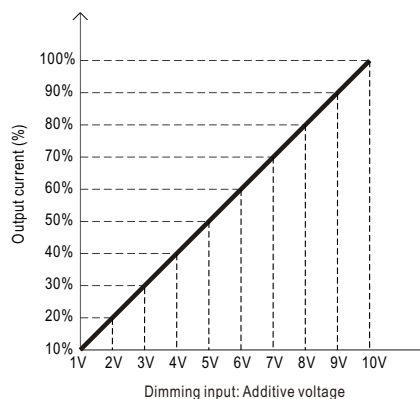
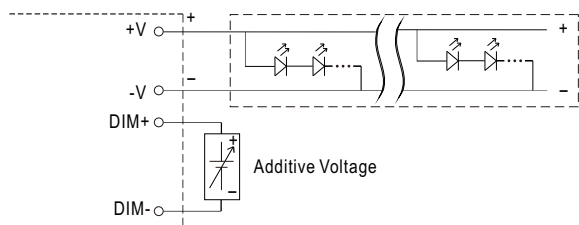

#### ◎ Applying additive 10V PWM signal (frequency range 100Hz ~ 3KHz):

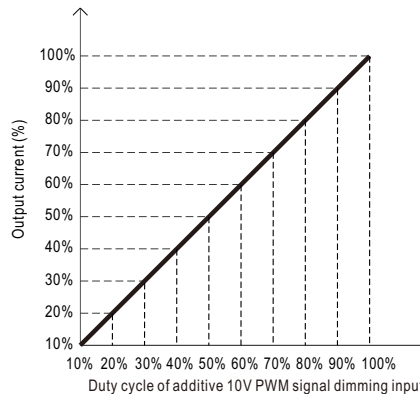
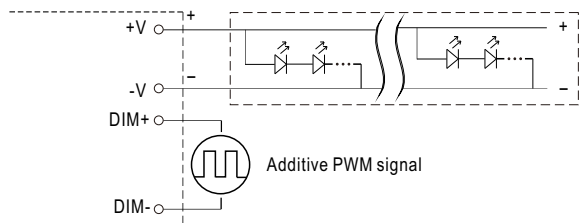

#### ◎ Applying additive resistance:

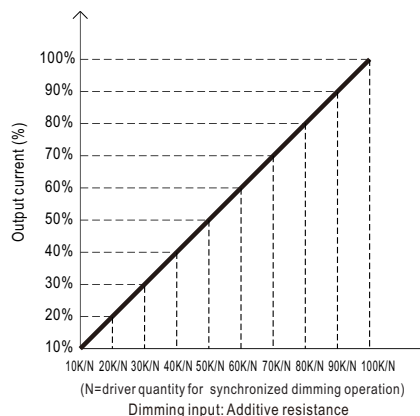
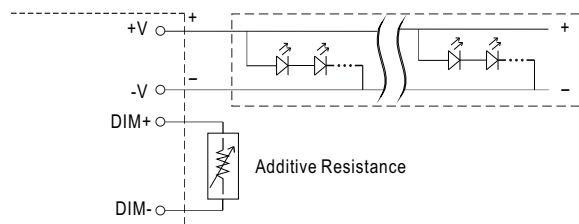

Note: In the case of turning the lighting fixture down to 0% brightness, please refer to the configuration as follow, or please contact MEAN WELL for other options.

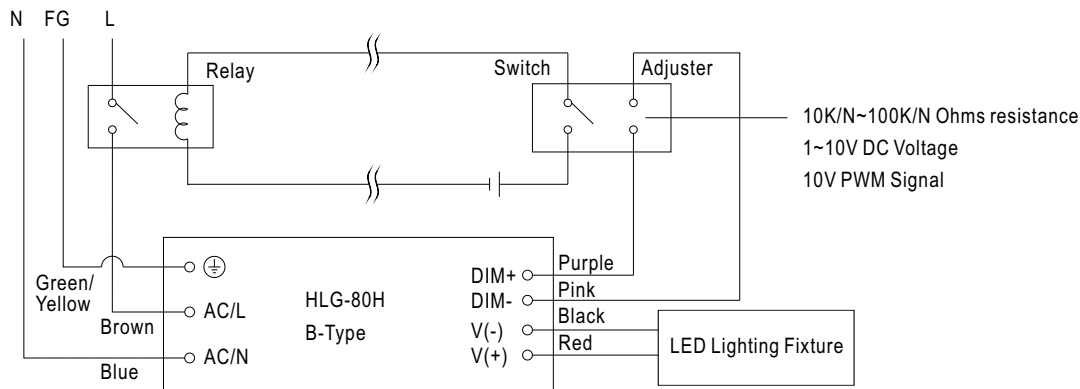

Using a switch and relay can turn ON/OFF the lighting fixture.

### OUTPUT LOAD vs TEMPERATURE(Notes.10)

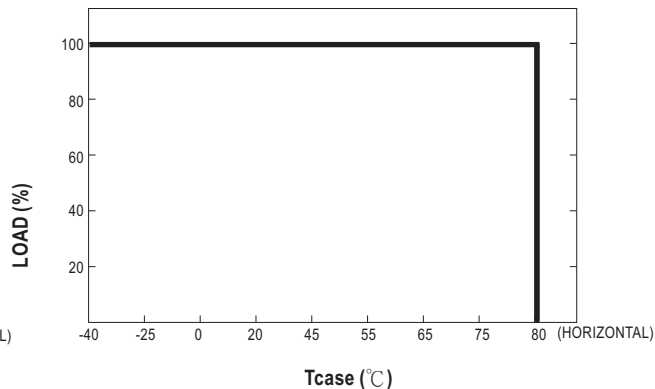
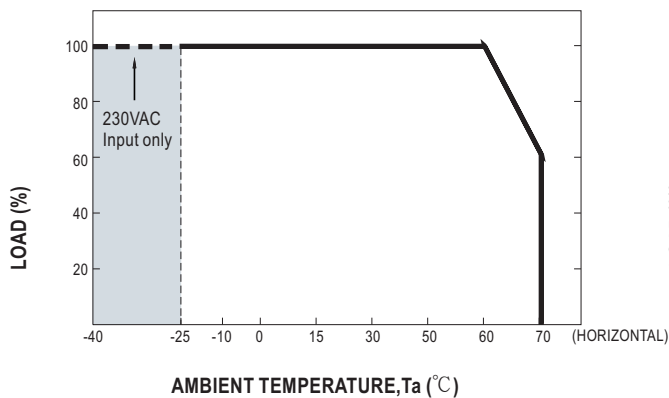

### STATIC CHARACTERISTICS

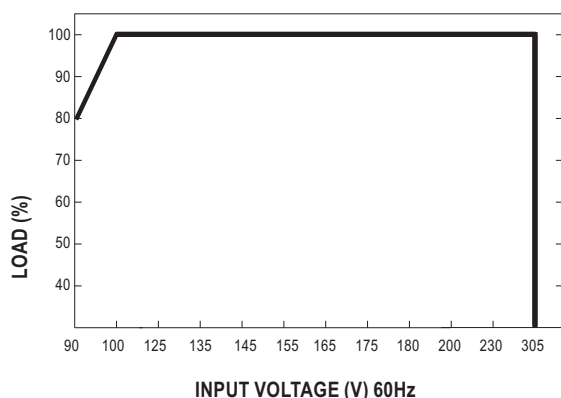

※ De-rating is needed under low input voltage.

### POWER FACTOR(PF) CHARACTERISTIC

※ Tcase at 70°C

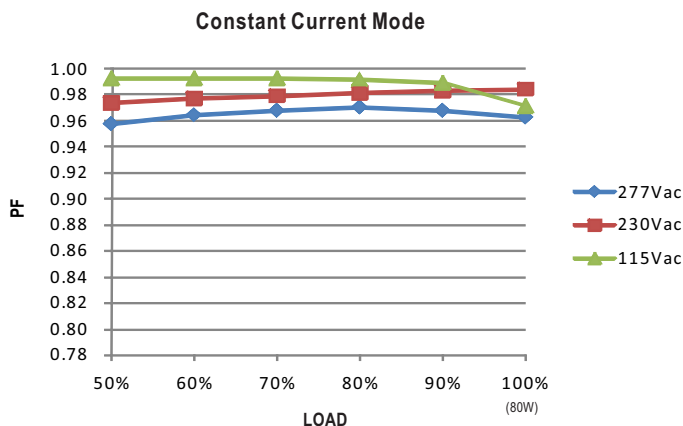

### TOTAL HARMONIC DISTORTION (THD)

※ 48V Model, Tcase at 70°C

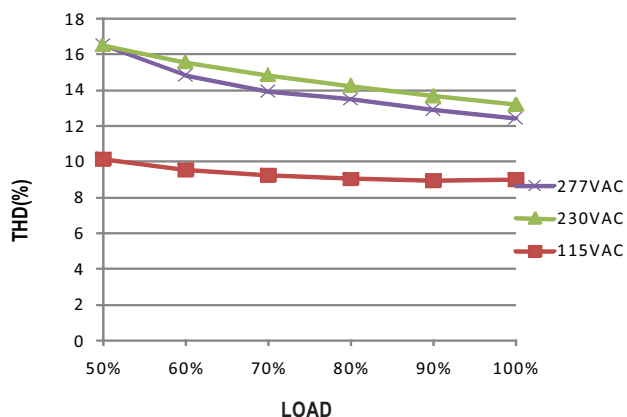

### EFFICIENCY vs LOAD

HLG-80H series possess superior working efficiency that up to 91% can be reached in field applications.

※ 48V Model, Tcase at 70°C

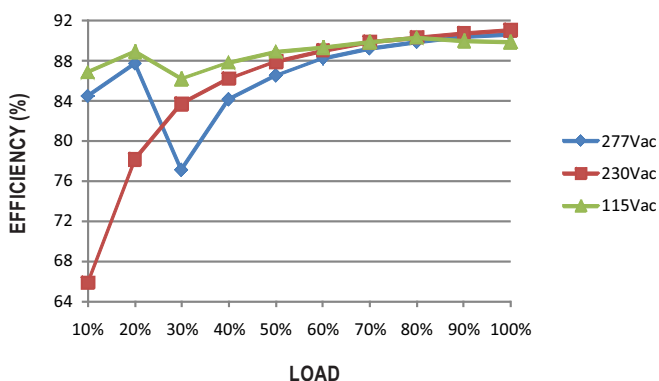

■ LIFE TIME

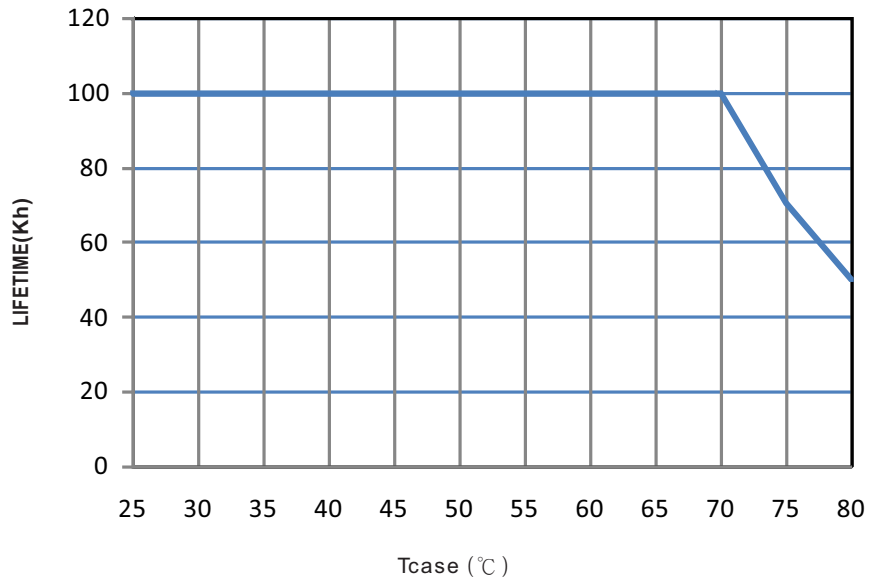

**MECHANICAL SPECIFICATION**

Case No.997A Unit:mm Tolerance:±1

※Blank/D-Type

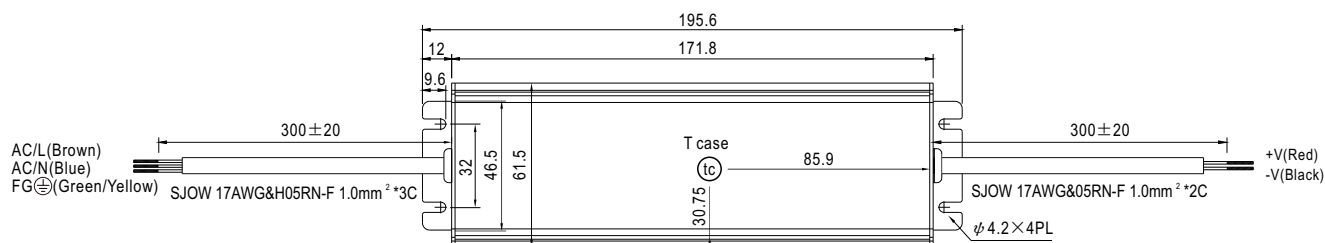

• (tc) : Max. Case Temperature

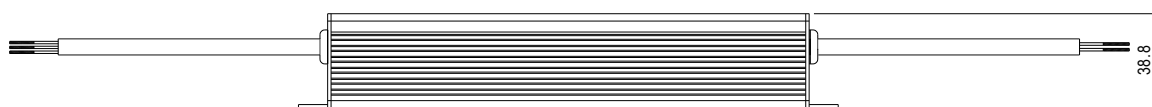

※A-Type

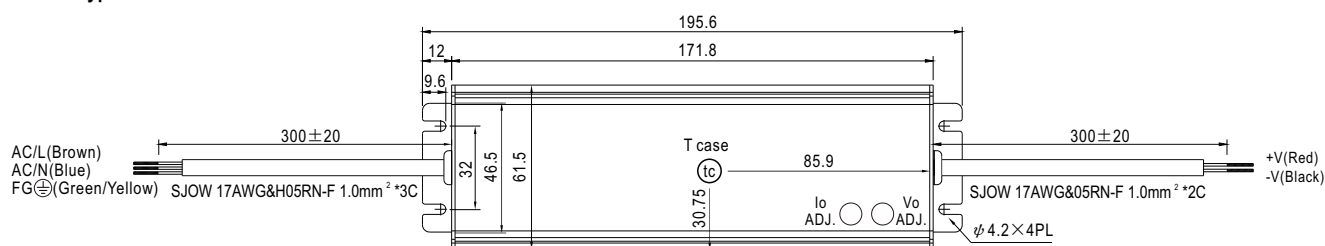

• (tc) : Max. Case Temperature



※B-Type

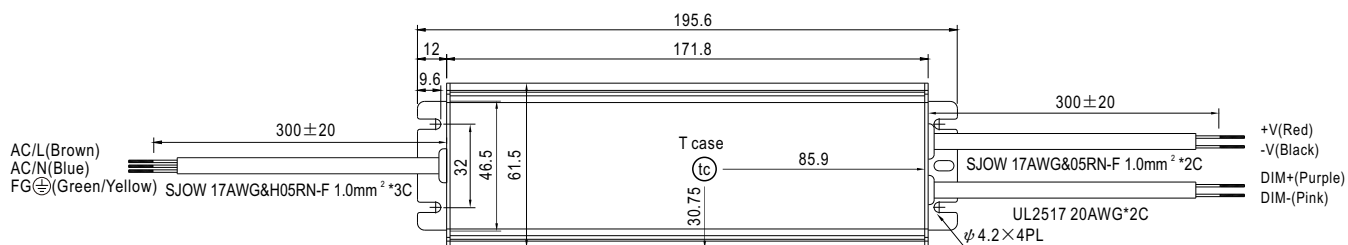

• (tc) : Max. Case Temperature

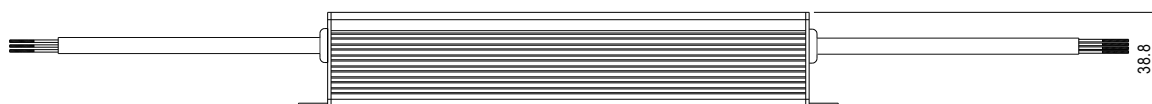

※AB-Type

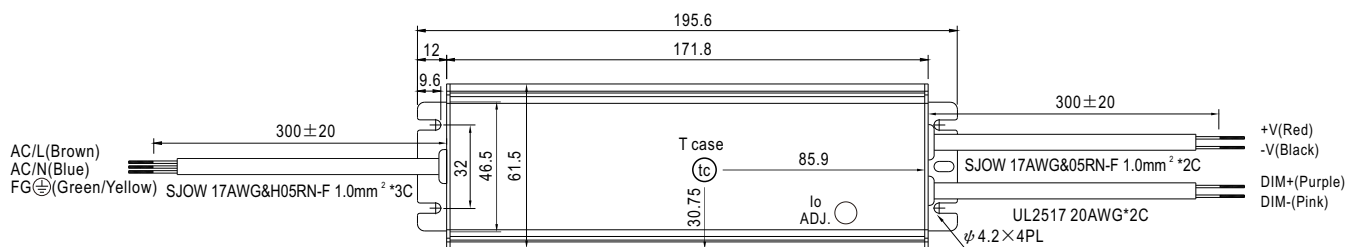

• (tc) : Max. Case Temperature

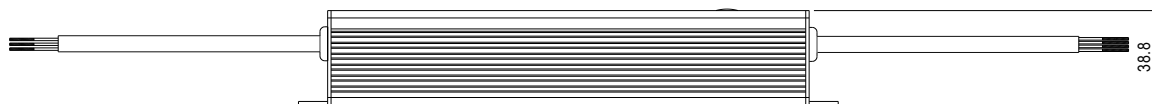

## WATERPROOF CONNECTION

### Waterproof connector

Waterproof connector can be assembled on the output cable of HLG-80H to operate in dry/wet/damp or outdoor environment.

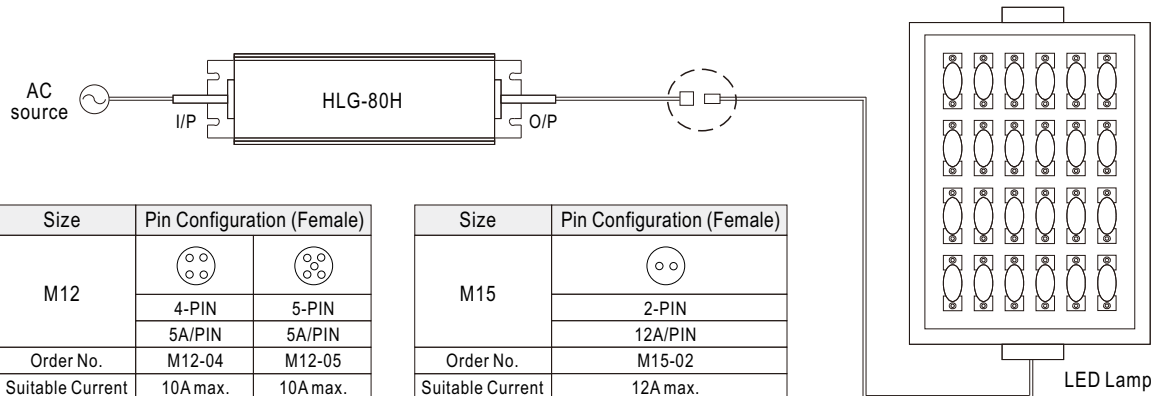

### Cable Joiner

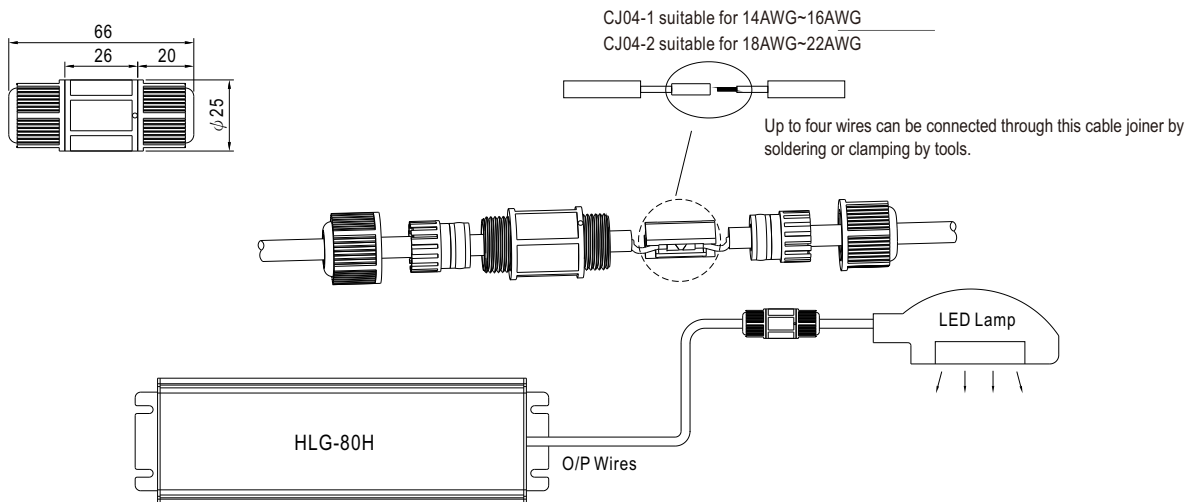

○ CJ04 cable joiner can be purchased independently for user's own assembly.  
MEAN WELL order No. : CJ04-1, CJ04-2.

### Junction Box Option

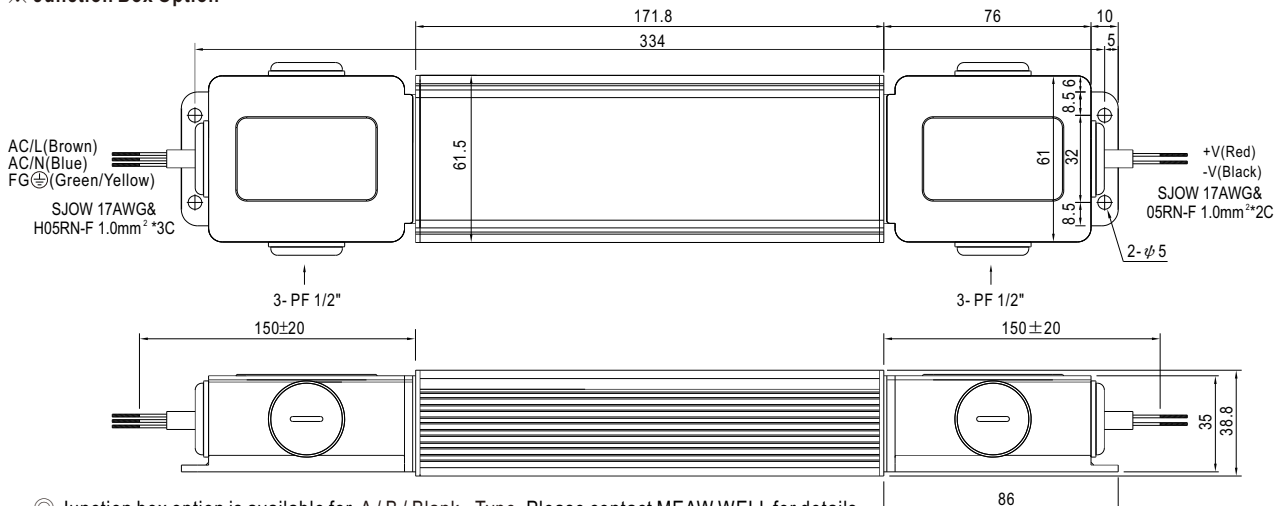

○ Junction box option is available for A / B / Blank - Type. Please contact MEAN WELL for details.  
○ HLG-80H-□BL models with junction box on both input and output sides are UL LISTED approved(modified by B type only).

## INSTALLATION MANUAL

Please refer to : <http://www.meanwell.com/manual.html>