

Sealed Surface-mounting Switches Sealed Structure for High Reliability. Available on Embossed Tape

- Sealed construction conforming to IP67 (IEC-60529) provides high reliability in locations exposed to dust or water. (* Excluding the terminal section.)
- Available with ground terminals for protection against static electricity.
- Use of a stainless-steel spring provides a crisp clicking action.
- Gold plated version enables stable contact and insulation over long periods of time.
- Available in embossed taping packages for automatic mounting.
- A small package containing 100 embossed taping reels is available, in addition to the standard package.

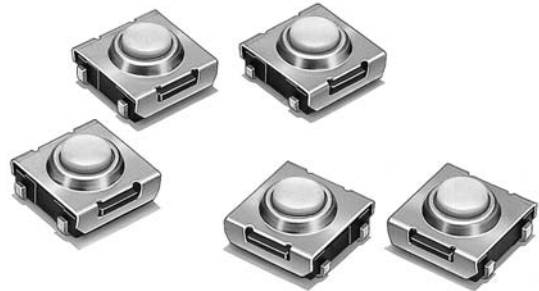

■ List of Models

6 × 6 mm Models

Operation type					Without ground terminal				With ground terminal			
					Bags		Embossed taping		Bags		Embossed taping	
					Model	Minimum packing unit	Model	Minimum packing unit	Model	Minimum packing unit	Model	Minimum packing unit
B3SN-3000 Series	Silver plated	3.1 mm	1.57 N {160 gf}	Ivory	B3SN-3012	100 pcs	B3SN-3012P	3,000 pcs	B3SN-3112	100 pcs	B3SN-3112P	3,000 pcs
							B3SN-3012P-R100	100 pcs			B3SN-3112P-R100	100 pcs
B3SN-G Series Gold-plated	Gold plated		1.76 N {180 gf}	Black	---	---	B3SN-3012P-G	3,000 pcs	---	---	---	---

Note: Switches in bags must be ordered in units of 100 pieces, and switches on embossed taping must be ordered in units of 3,000 pieces. Individual switches are not sold individually.

■ Ratings/Characteristics

Rating (resistive load)	1 to 50 mA, 3 to 24 VDC
Minimum applicable load (reference value)	10 μA at 1 VDC (resistive load)
Ambient operating temperature	-25°C to +70°C at 60%RH max. (with no icing or condensation)
Ambient operating humidity	35% to 85% (at +5 to +35°C)
Contact form	SPST-NO
Contact resistance (initial value)	100 mΩ max.
Insulation resistance	100 MΩ min. (at 250 VDC with insulation tester)
Dielectric strength	250 VAC, 50/60 Hz for 1 min
Bounce time	5 ms max.
Vibration resistance	Malfunction: 10 to 55 Hz, 1.5-mm double amplitude
Shock resistance	Destruction: 1,000 m/s ² {approx. 100G} max.
Durability	100,000 operations min.
Weight	Approx. 0.2 g
Degree of protection	IEC IP67
Washing	Possible

■ Operating Characteristics

Item	Type	B3SN-3000 Series	B3SN-G Series
Operating force (OF)		1.57±0.49 N {160±50 gf} max.	1.76±0.59 N {180±60 gf} max.
Releasing force (RF)		0.29 N {30 gf} min.	
Pretravel (PT)		0.25±0.15 mm	

■ Model Structure

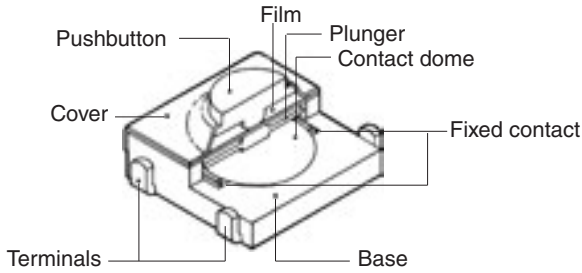

■ Dimensions

Note: The numbers used for terminals in the following graphics are indicated in the “Bottom View” diagram below. In this diagram, the Switch is rotated so that the terminals are on the right and left-hand sides, and the OMRON logo appears the right way up.



Without Ground Terminal

B3SN-3012
B3SN-3012P
B3SN-3012-G
B3SN-3012P-R100

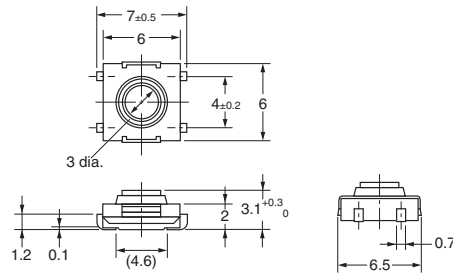

PCB Pad (Top View)

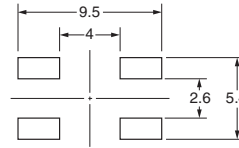

Terminal Arrangement /Internal Connections (Top View)

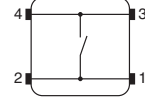

With Ground Terminal

B3SN-3112
B3SN-3112P
B3SN-3112P-R100

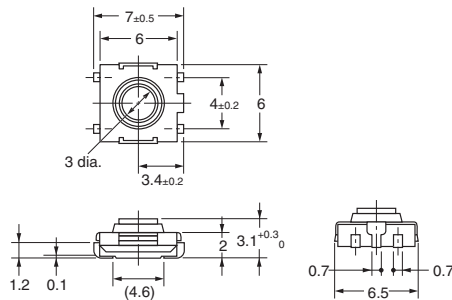

PCB Pad (Top View)

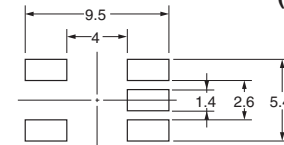

Terminal Arrangement /Internal Connections (Top View)

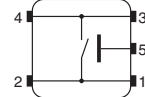

Note: Unless otherwise specified, a tolerance of ± 0.3 mm applies to all dimensions. No terminal numbers are indicated on the Switches.

■ Precautions

Be sure to read the safety precautions common to all Tactile Switches on pages for correct use.

Please check each region's Terms & Conditions by region website.

OMRON Corporation

Device & Module Solutions Company

Regional Contact

Americas

<https://components.omron.com/us>

Asia-Pacific

<https://components.omron.com/ap>

Korea

<https://components.omron.com/kr>

Europe

<https://components.omron.com/eu>

China

<https://components.omron.com.cn>

Japan

<https://components.omron.com/jp>

© OMRON Corporation 2007-2022 All Rights Reserved.
In the interest of product improvement, specifications are subject to change without notice.

Cat. No. C096-E1-08
1122 (0207)