

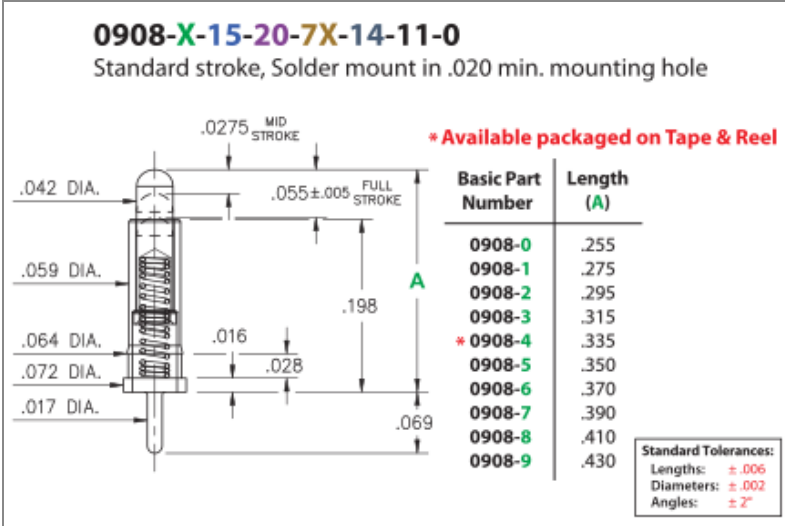

PRODUCT NUMBER: 0908-2-15-20-75-14-11-0

www.mill-max.com
DATA SHEET



0908-2-15-20-75-14-11-0 SPECIFICATIONS

General Info	
Description¹:	Spring-Loaded Pin with a Standard Tail
Plunger Type:	Round
Mounting Feature²:	Through-Hole Solder Mount
Mounting Hole:	.020" (0,508mm)
Initial Height:	.295" (7,493mm)
Stroke:	.055" (1,397mm)
Packaging:	Packaged in Bulk
RoHS³:	Yes
Product Lifecycle⁴:	Active

Materials
Shell Material⁵: Brass Alloy
Shell Plating⁶: 20 μ" Gold over Nickel
Spring Plating⁷: 10 μ" Gold over Nickel

Technical Specs	
Durability:	Up to 1,000,000 Cycles @ Mid-Stroke
Operating Temperature Range⁸:	-55/+125° C
Current Rating⁹:	See Spring Specifications Below
Contact Resistance¹⁰:	See Spring Specifications Below
Shock¹¹:	No Elect. Discontinuity > 1μs @ 50g
Vibration¹²:	No Elect. Discontinuity > 1μs @ 10-2000HZ, 20 G

NOTES:

1. Standard Tolerances:
Lengths $\pm .006''$ (0,15)
Diameters: $\pm .002''$ (0,051)
Angles: $\pm 2^\circ$
2. For through-hole solder mounting of this part, the suggestion is to make the finished hole size, at its minimum, .004" larger than the diameter being soldered into the mounting hole.
3. Mill-Max products labeled with the RoHS symbol are compliant with all three ROHS Directives. All of our products previously described as RoHS (2002/95/EC) and RoHS-2 (2011/65/EC) are also compliant with RoHS-3 (2015/863/EU).
4. Part is Active and in Production, No Scheduled Obsolescence
5. Brass Alloy 360 per ASTM B 16, or 385 per ASTM B455
6. GOLD per ASTM B 488, Type 1 (99.7% min. gold), Code C (130-200 HK {Knoop hardness}); NICKEL per ASTM B 689, Type 2 (Bright)
7. GOLD per ASTM B 488, Type 1 (99.7% min. gold), Code C (130-200 HK {Knoop hardness}), NICKEL per ASTM B 689, Type 2 (Bright)
8. Storage per IEC 60512-11-(4,9,10,12) and peak operating temperature per IEC 60512-5-2, Test 5b
9. Per IEC 60512-5-2; Current Carrying Capacity; Current Derating
10. Per EIA-364-23C: Low Level Contact Resistance.
11. Per IEC 60512-6-3: Test 6c: Shock
12. Per IEC 60512-6-4: Test 6d: Vibration (sinusoidal)

ADDITIONAL PARTS, PACKAGING, & ASSEMBLY INFO

0908-4-15-20-7X-14-11-0

Standard stroke, Solder mount in .020 min. mounting hole
32mm wide X 12mm pitch carrier tape: 450 parts per 13" reel

Order as: 0908-4-57-20-7X-14-11-0

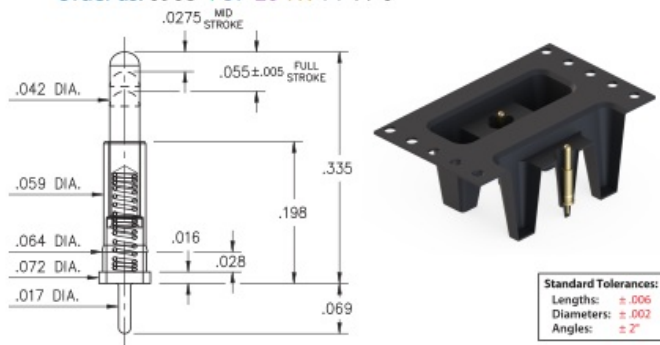

SPRING:

#75 SPRING STANDARD FORCE SPRING	Full Stroke Capability : .055"± .005" [1,4 ± 0,127]
Spring Material : Beryllium Copper Alloy 172	Force @ Mid. Stroke : 60 g ± 20 g
Mid. Stroke : .0275" [0,7]	Initial Force (Pre-Load) : 10 g

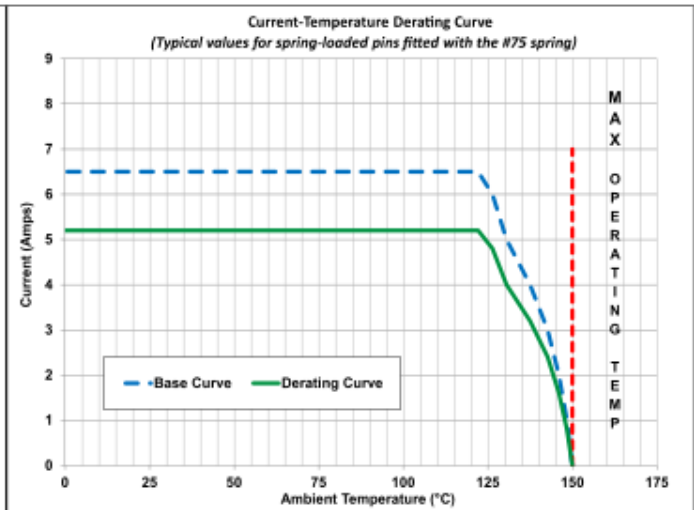
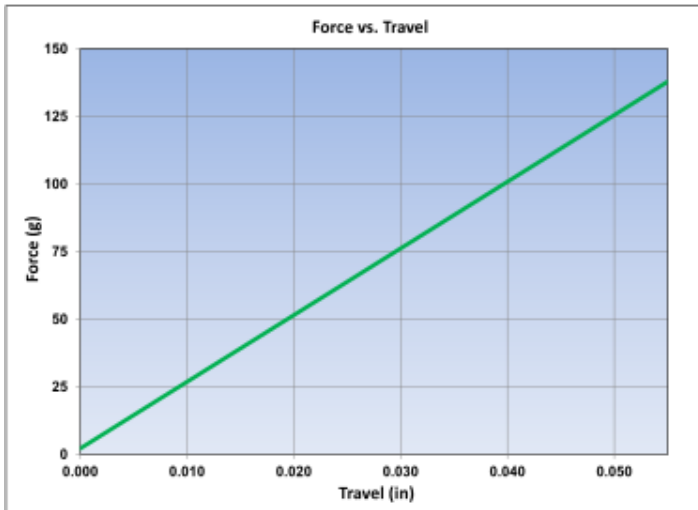

The stroke, force and current rating values are measured using spring pins with an internal construction per the design specification. Individual spring pin performance may vary from these values based on design differences.

Material	Beryllium Copper	Grams Force	60.0000g
Max Stroke	0.06	Maximum Current	6.5A @ 30° C Temp. Rise
Maximum Operating Temp @ Max Current	120.00° C	20% De-rated Maximum Current	5.20A
Contact Resistance	20.00mΩ Max		

ADDITIONAL NOTES AND SPECIFICATIONS

In the interest of improved design, quality and performance, Mill-Max reserves the right to make changes in its specifications without prior notice. Specifications and tolerances are provided wherever possible. The tolerance on dimensions of critical to function features is typically held tighter than the stated standard tolerances, such as press-fits, holes and lengths affecting the coplanarity of SMT products. Due to the wide variety of interconnects Mill-Max offers, the specific tolerances vary from product to product. If you need information regarding the tolerance of a particular part, please contact Technical Services.

RELATED LINKS AND DOCUMENTS

Engineering Notebook: (<https://www.mill-max.com/engineering-notebooks/spring-loaded-pogo-pins-connectors>)

Environmental Compliance: (<https://www.mill-max.com/rohs>)