

GRF2501
HIGH GAIN ULTRA-LNA
802.11ac 4.3 to 9 GHz

FEATURES

- Flexible Bias Voltage and Current
- Internally Matched to 50 Ω
- Process: GaAs pHEMT
- Compact 1.5 x 1.5 mm DFN-6 Package

Reference: 3.3 V / 18 mA / 5.5 GHz

- Gain: 17 dB
- OP1dB: 9 dBm
- Evaluation Board Noise Figure: 1 dB

APPLICATIONS

- WiFi Access Points
- Mobile WiFi Devices
- 802.11p Vehicle Communications
- Microwave Backhaul

DESCRIPTION

The GRF2501 is an ultra-low noise amplifier (LNA) designed for IEEE 802.11a/n/ac/p applications in the 4 GHz band and up to 9 GHz with appropriate matching.

The LNA can be operated from a single positive supply of 2.7 to 5 V with a typical bias condition of 3.3 V, 18 mA and is internally matched to 50 Ω at the input and output ports.

Please consult with the GRF applications engineering team for custom tuning/evaluation board data and device S-parameters.

Additional tunes can be found on the GRF2501 "Custom Tunes" product page: [GRF2501 Custom Tunes](#)

BLOCK DIAGRAM

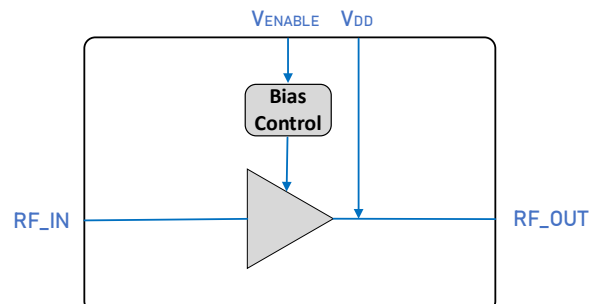

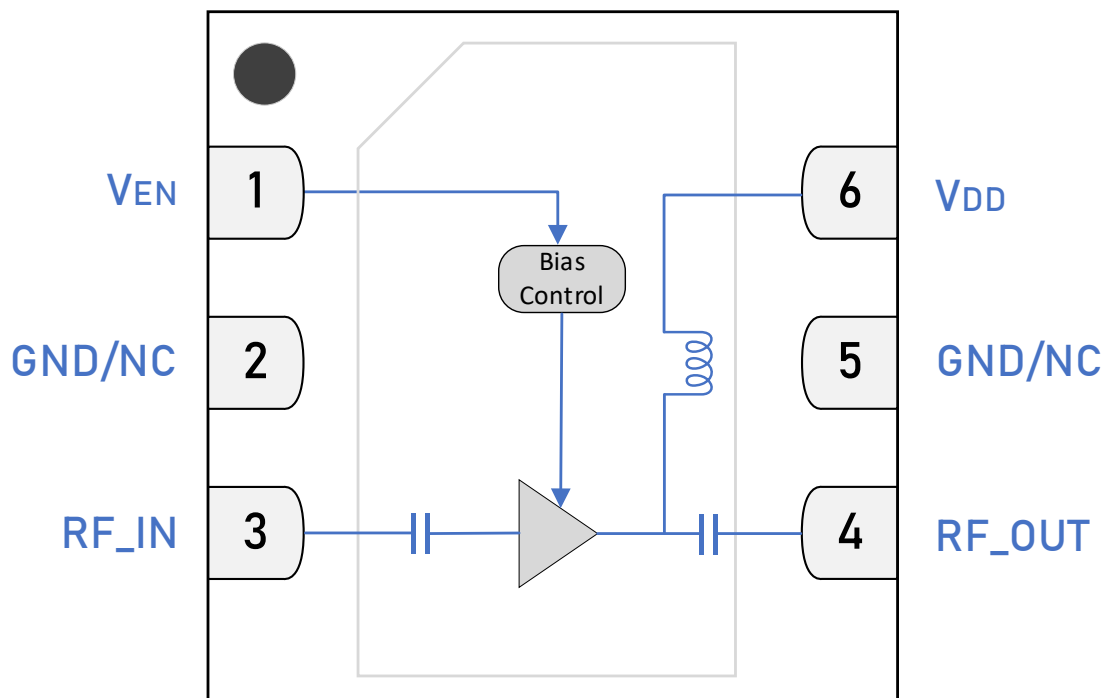

1.5 x 1.5 mm DFN-6 Pin Out (Top View)

Pin Assignments

Pin	Name	Description	Note
1	V _{EN}	LNA Enable	V _{ENABLE} and series resistor set I _{DDQ} . V _{ENABLE} ≤ 0.2 volts disables the device. On-die pull-down resistor will turn the device off if this node is allowed to float.
2, 5	GND/NC	Ground or No Connect	No internal connection to die. We recommend connecting these pins to ground.
3	RF_IN	LNA RF Input	Internally matched to 50 Ω. These ports may be DC connected to ground externally but no DC > 0.2 volts should be applied to these ports.
4	RF_OUT	LNA RF Output	Internally matched to 50 Ω. These ports may be DC connected to ground externally but no DC > 0.2 volts should be applied to these ports.
6	V _{DD}	LNA Supply Voltage	Requires Bypass capacitance as close as possible to pin on PCB.
PKG BASE	GND	Ground	Provides DC and RF ground for device as well as thermal heat sink. Recommend multiple 8-mil vias beneath the package for optimal RF and thermal performance. Refer to evaluation board top layer graphic on schematic page.

V_{ENABLE} Truth Table:

V _{DD}	V _{ENABLE}	Mode
High	≥ 1.8 V	LNA On
High	< 0.1 V	LNA Off

Absolute Ratings

Parameter	Symbol	Min.	Max.	Unit
Supply Voltage	V_{DD}	0	6	V
RF Input Power: Load VSWR < 2:1, $V_{DD} = 5$ V	$P_{IN\ MAX}$		15	dBm
Operating Temperature (package base)	$T_{PKG\ BASE}$	-40	105	°C
Maximum Channel Temperature (MTTF > 10 ⁶ hours)	T_{MAX}		170	°C
Maximum Dissipated Power	$P_{DISS\ MAX}$		200	mW

Electrostatic Discharge

Human Body Model	HBM	250		V
------------------	-----	-----	--	---

Storage

Storage Temperature	T_{STG}	-65	150	°C
Moisture Sensitivity Level	MSL		1	--



Caution! ESD Sensitive Device.

Exceeding Absolute Maximum Rating conditions may cause permanent damage.

Note: For additional information, please refer to *Package Manufacturing Information* | *Guerrilla RF* (guerrilla-rf.com)



All Guerrilla RF products are provided in RoHS compliant lead (Pb)-free packaging requiring no exemptions. Additional information for this topic can be found at this link - *Environmental and Restricted Substance Statement Library*.

Recommended Operating Conditions

Parameter	Symbol	Specification			Unit	Condition
		Min.	Typ.	Max.		
Supply Voltage	V _{DD}	2.7	3.3	5	V	
Operating Temperature (package base)	T _{PKG BASE}	-40		105	°C	
RF Frequency Range	F _{RF}	4.3	5.5	9	GHz	Typical application schematic with external matching components (notes 1 & 2).
RF_IN Port Impedance	Z _{RF_IN}		50		Ω	
RF_OUT Port Impedance	Z _{RF_OUT}		50		Ω	

Note 1: Operation outside of this range is supported by using different custom tunes. Examples of other optimized tunes can be found here: [GRF2501 Custom Tunes](#)

Note 2: Contact the Guerrilla RF Applications team for guidance on optimizing the tuning of the device for alternative bands.

Nominal Operating Parameters – General

The following conditions apply unless noted otherwise: typical application schematic using the 5.1 to 5.925 GHz tuning set. $V_{DD} = 3.3\text{ V}$, $V_{ENABLE} = 3.3\text{ V}$, $M5 = 1\text{ k}\Omega$, $I_{DD} = 18\text{ mA}$, $F_{TEST} = 5.5\text{ GHz}$, $T_{PKG\text{ BASE}} = 25\text{ }^{\circ}\text{C}$. Evaluation board losses are included within the specifications.

Parameter	Symbol	Specification			Unit	Condition
		Min.	Typ.	Max.		
Supply Current	I_{DD}	12	18	28	mA	$R_{bias} = 1\text{ k}\Omega$.
Enable Current	I_{ENABLE}		1.5	3	mA	

Disabled Mode

Supply Current (leakage)	$I_{LEAKAGE}$		200	500	μA	$V_{DD} = 3.3\text{ V}$, $V_{ENABLE} = 0\text{ V}$.
--------------------------	---------------	--	-----	-----	---------------	---

Thermal Data

Thermal Resistance (Infrared Scan)	Θ_{JC}		150		$^{\circ}\text{C}/\text{W}$	On standard evaluation board (note 3).
Channel Temperature at 85 $^{\circ}\text{C}$ (reference package base)	$T_{CHANNEL}$		99		$^{\circ}\text{C}$	$V_{DD} = 3.3\text{ V}$, $I_{DDQ} = 28\text{ mA}$. No RF applied. $P_{DISS} = 92\text{ mW}$ (note 3).

Note 3: MTTF > 10^6 hours for $T_{CHANNEL} \leq 170\text{ }^{\circ}\text{C}$.

Nominal Operating Parameters – RF

The following conditions apply unless noted otherwise: typical application schematic using the 5.1 to 5.925 GHz tuning set. $V_{DD} = 3.3\text{ V}$, $V_{ENABLE} = 3.3\text{ V}$, $M5 = 1\text{ k}\Omega$, $I_{DD} = 18\text{ mA}$, $F_{TEST} = 5.5\text{ GHz}$, $T_{PKG\ BASE} = 25\text{ }^{\circ}\text{C}$. Evaluation board losses are included within the specifications.

Parameter	Symbol	Specification			Unit	Condition
		Min.	Typ.	Max.		
Gain	S21	15	17		dB	
Noise Figure	NF		1	1.2	dB	On standard evaluation board.
Input Power at 1% EVM	IP1%		-19		dBm	802.11ac modulation.
Output 1 dB Compression Power	OP1dB	6	9		dBm	

GRF2501 Typical Operating Curves: 3.3 V, 18 mA, 5.1 to 5.925 GHz Tune

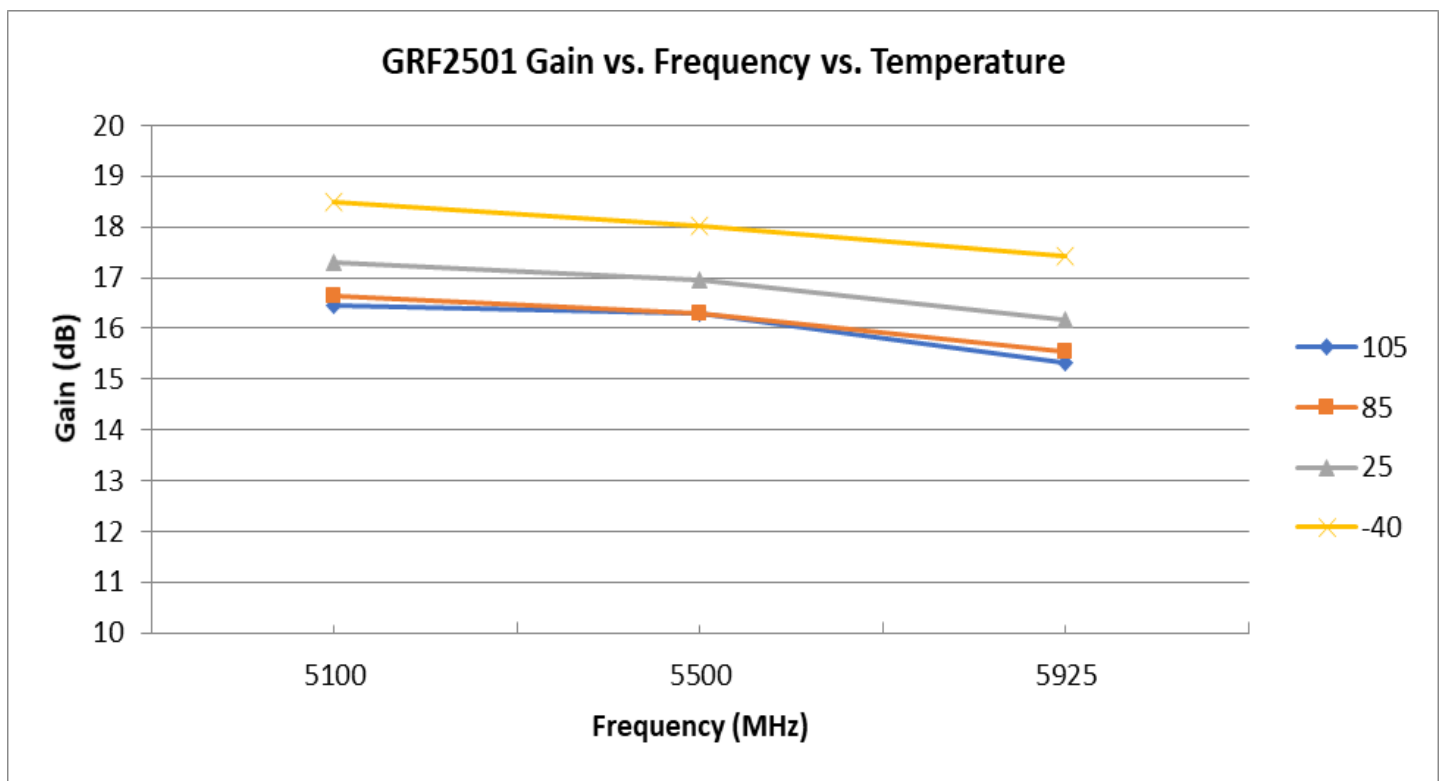
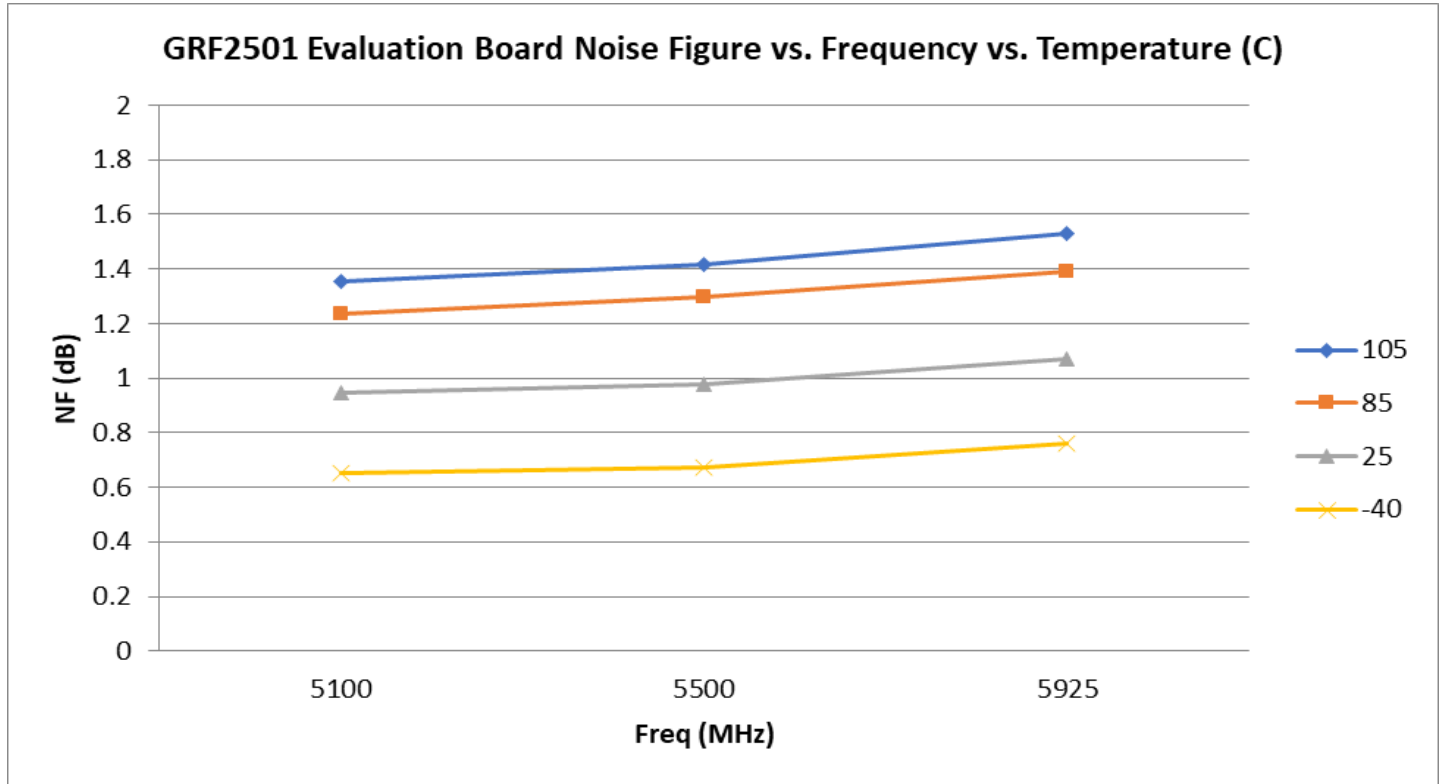

GRF2501 Typical Operating Curves: 3.3 V, 18 mA, 5.1 to 5.925 GHz Tune

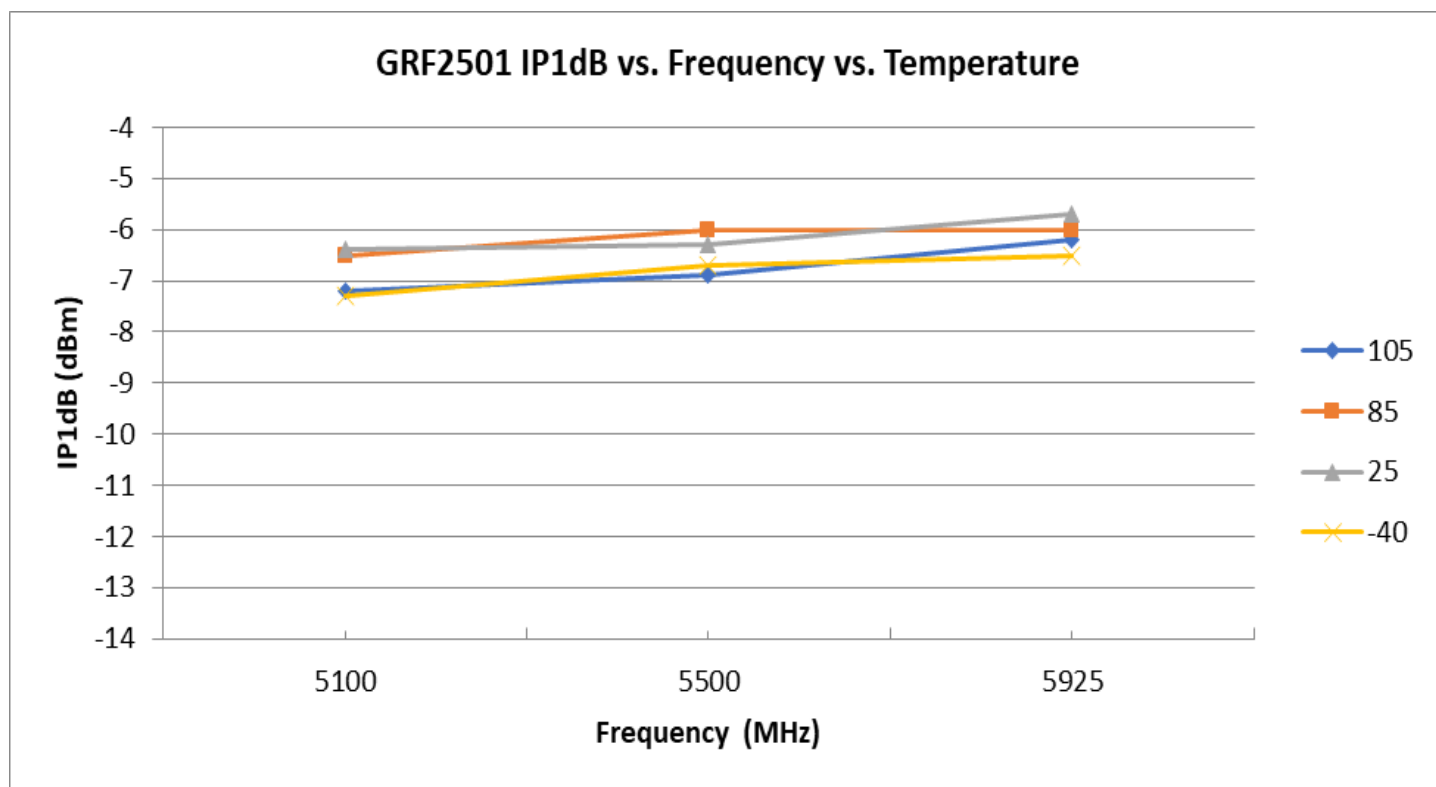
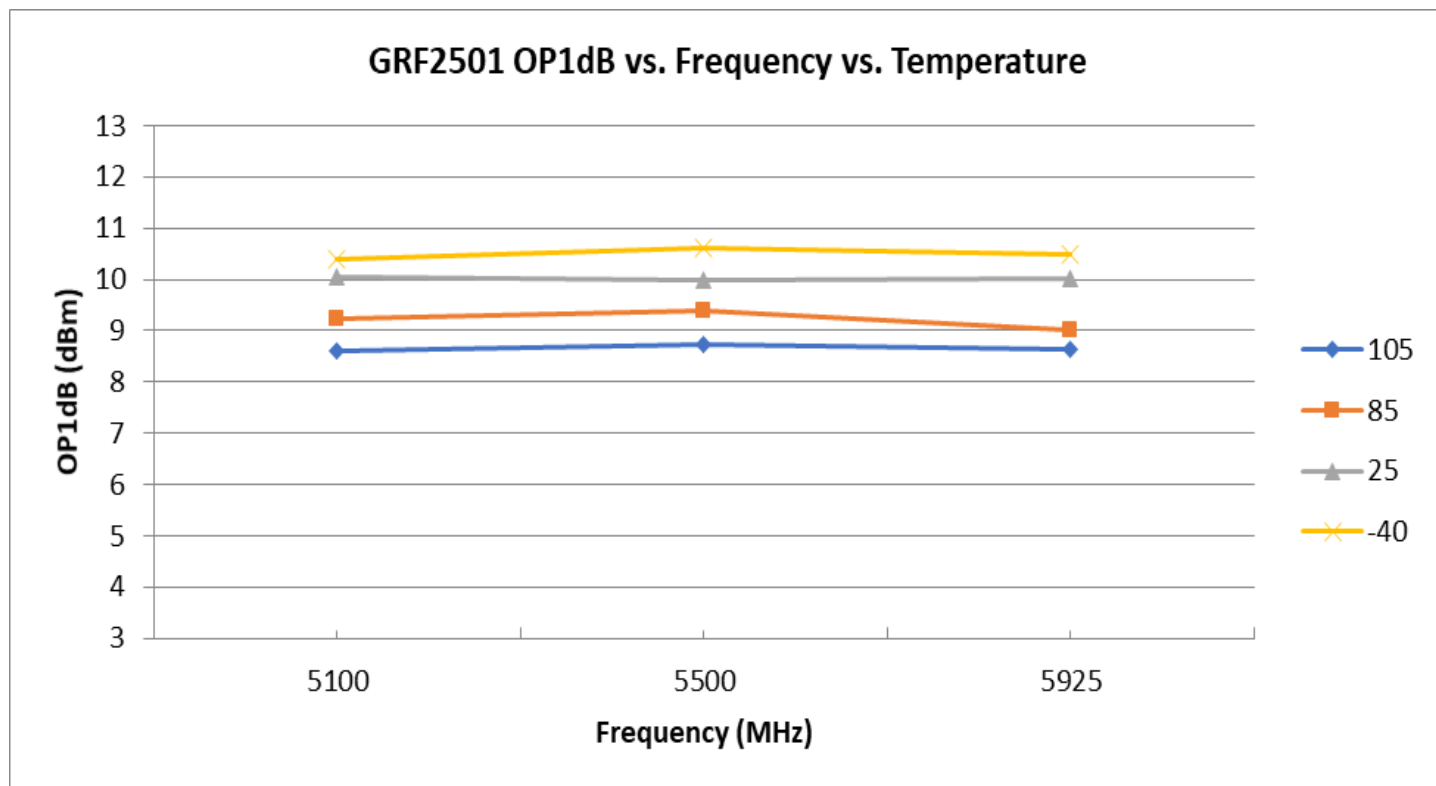

GRF2501 Typical Operating Curves: 3.3 V, 18 mA, 5.1 to 5.925 GHz Tune

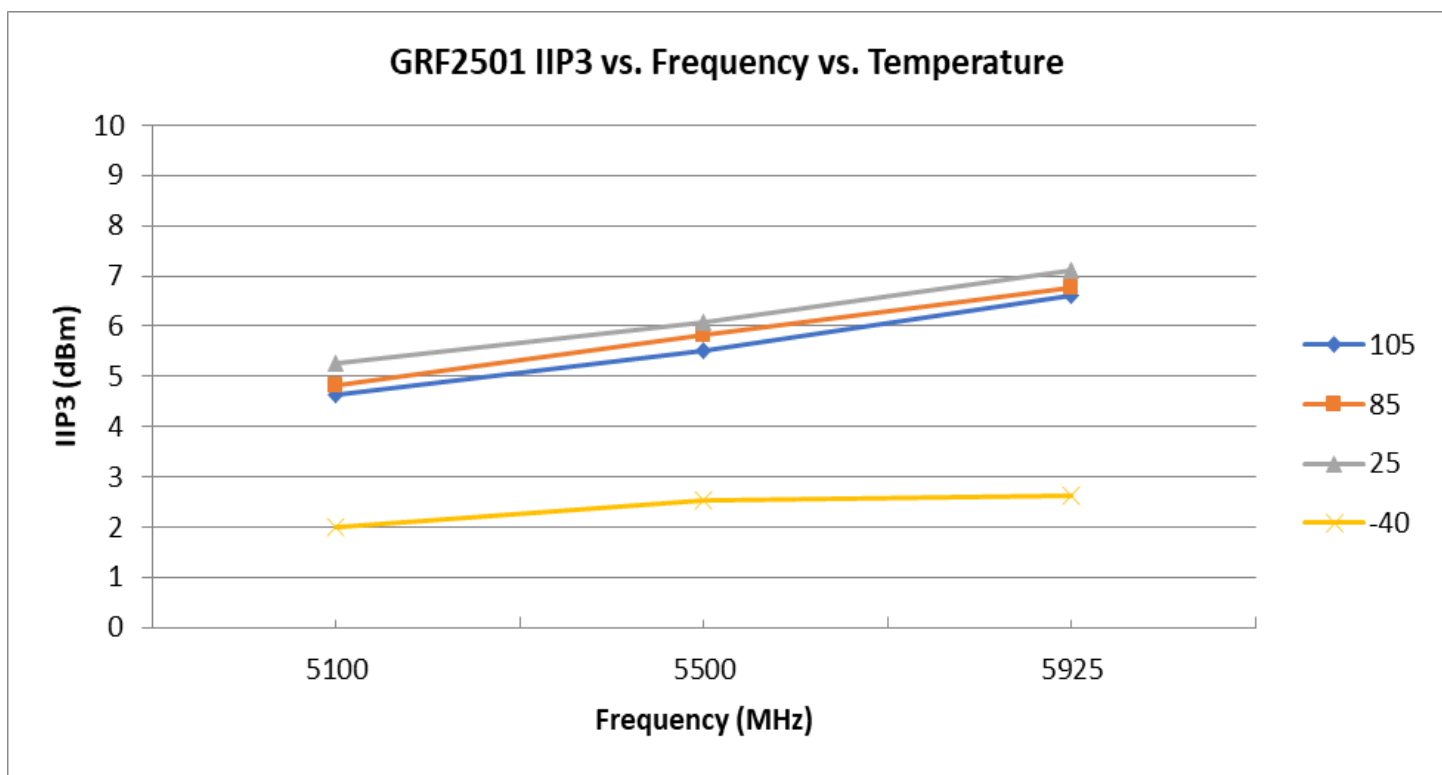
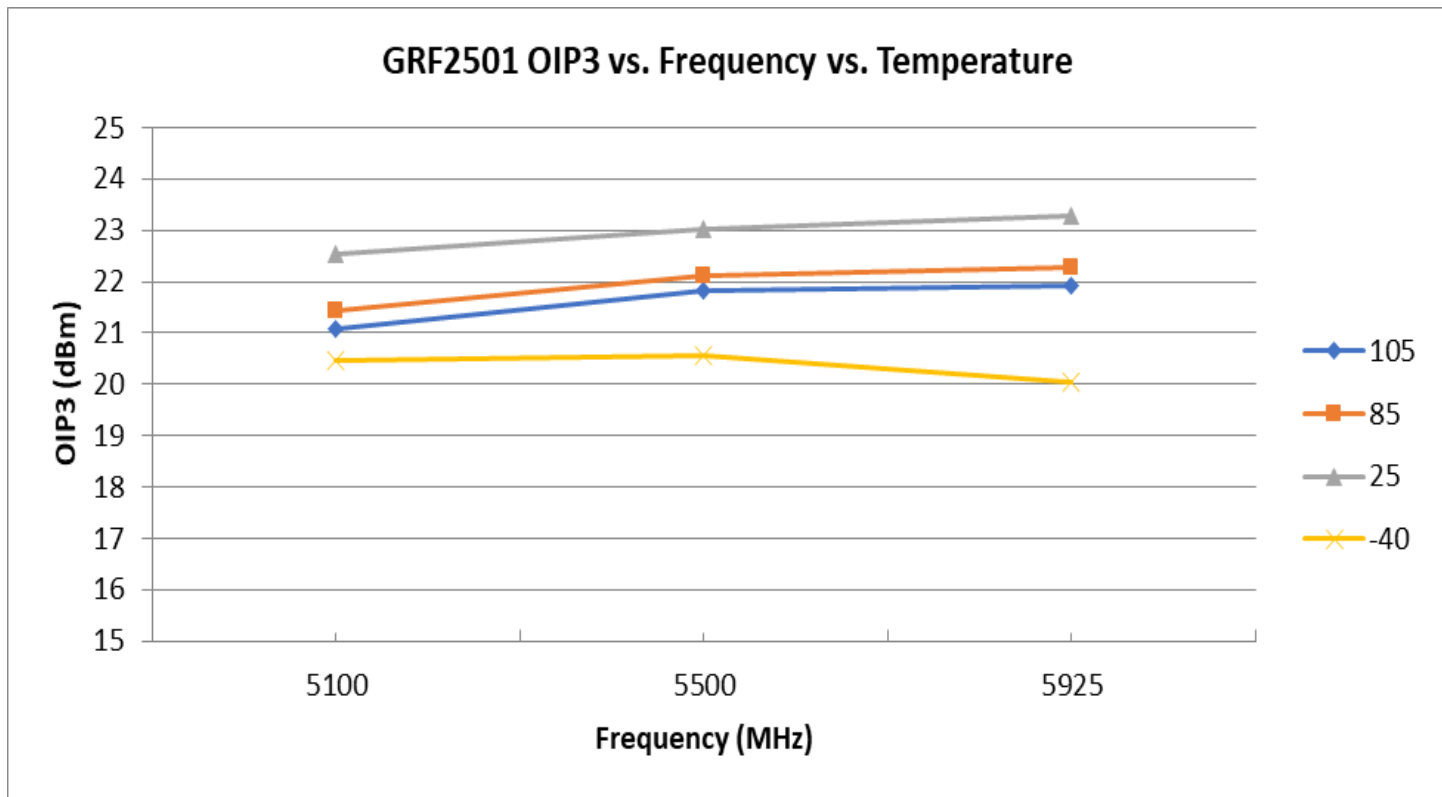

GRF2501 Typical Operating Curves: 3.3 V, 18 mA, 5.1 to 5.925 GHz Tune

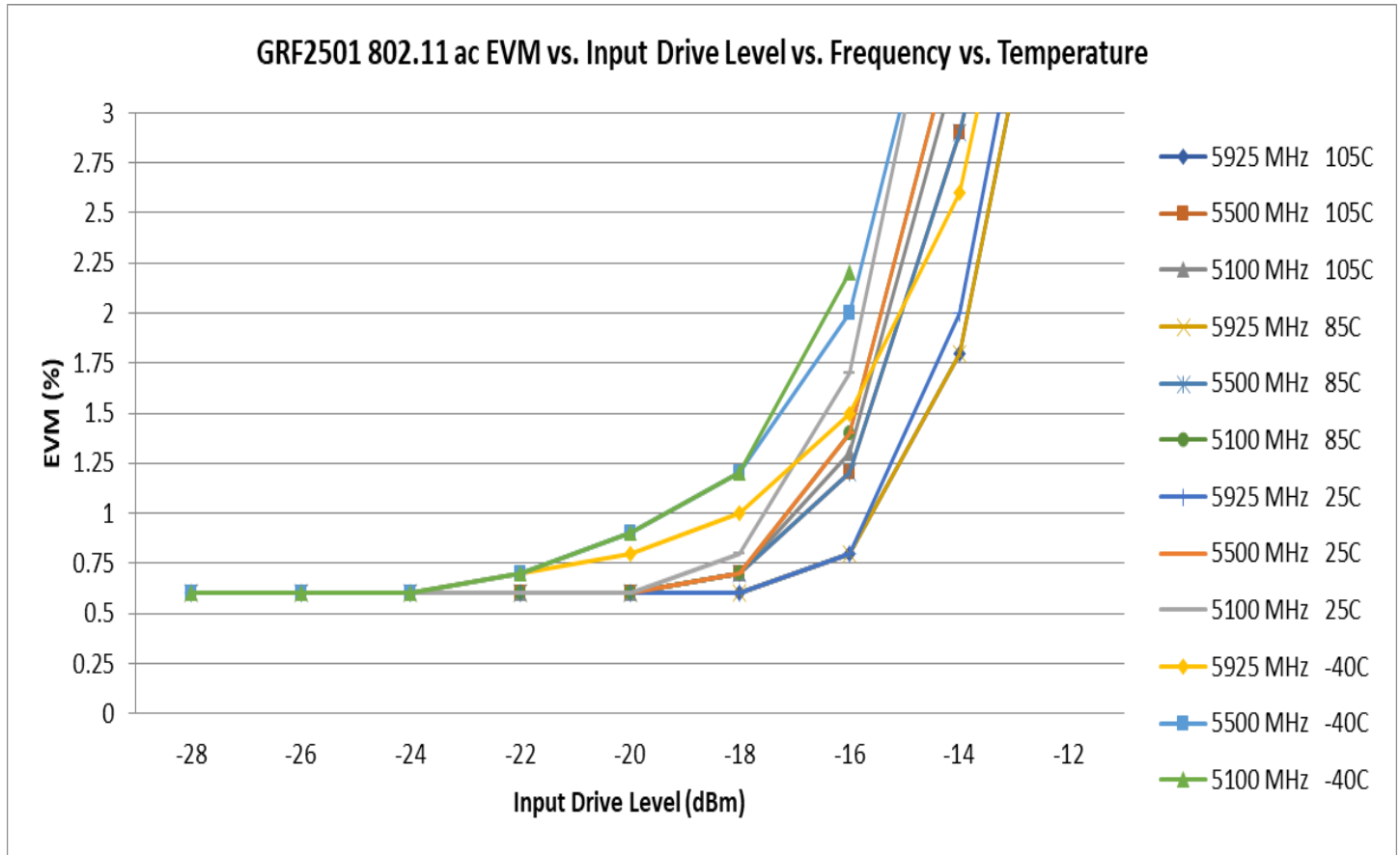

GRF2501 Typical Operating Curves: S-Parameters (5.1 to 5.925 GHz Tune)

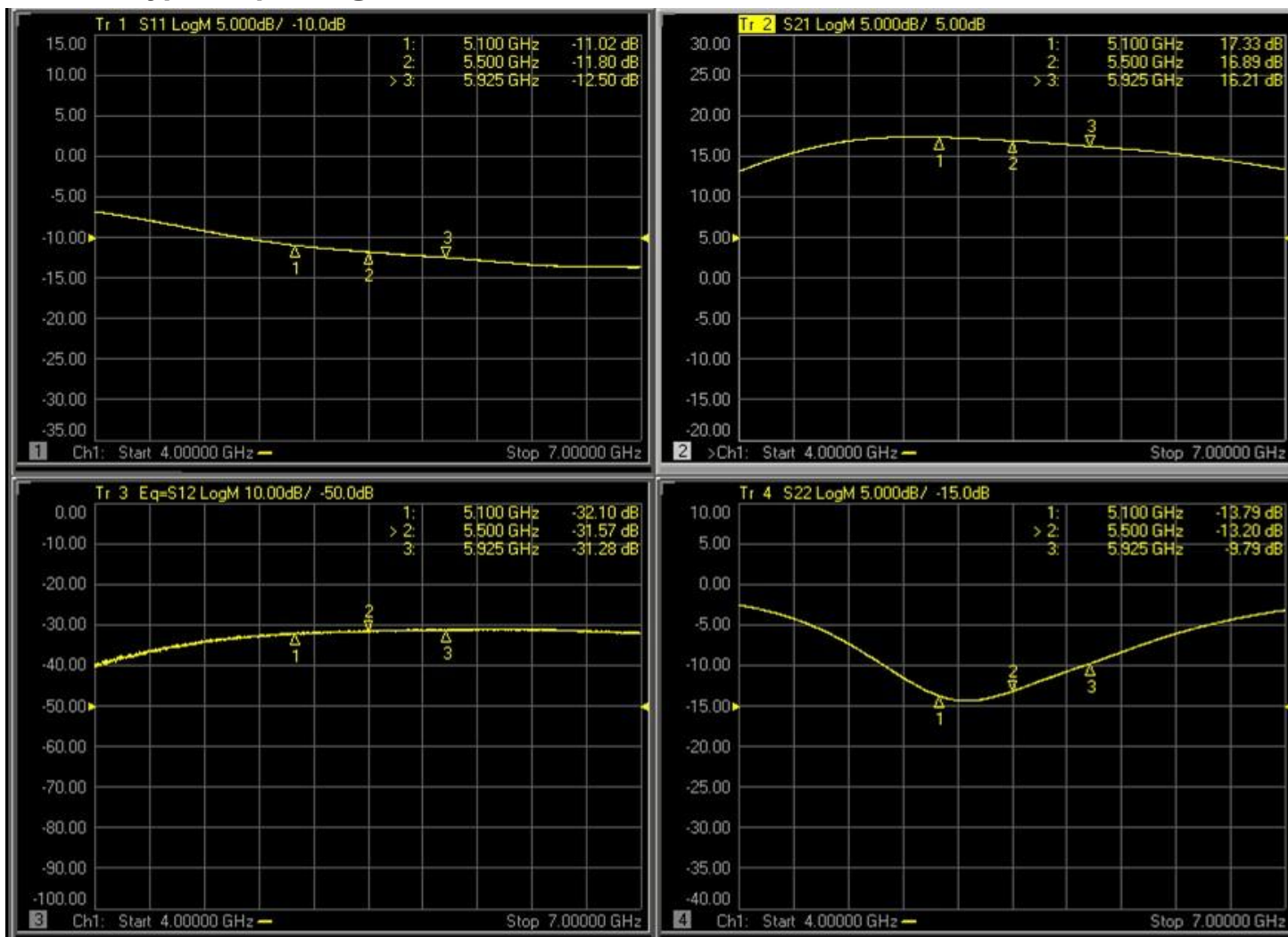

GRF2501 Typical Operating Curves: Stability Mu Factor (10 MHz to 20 GHz)

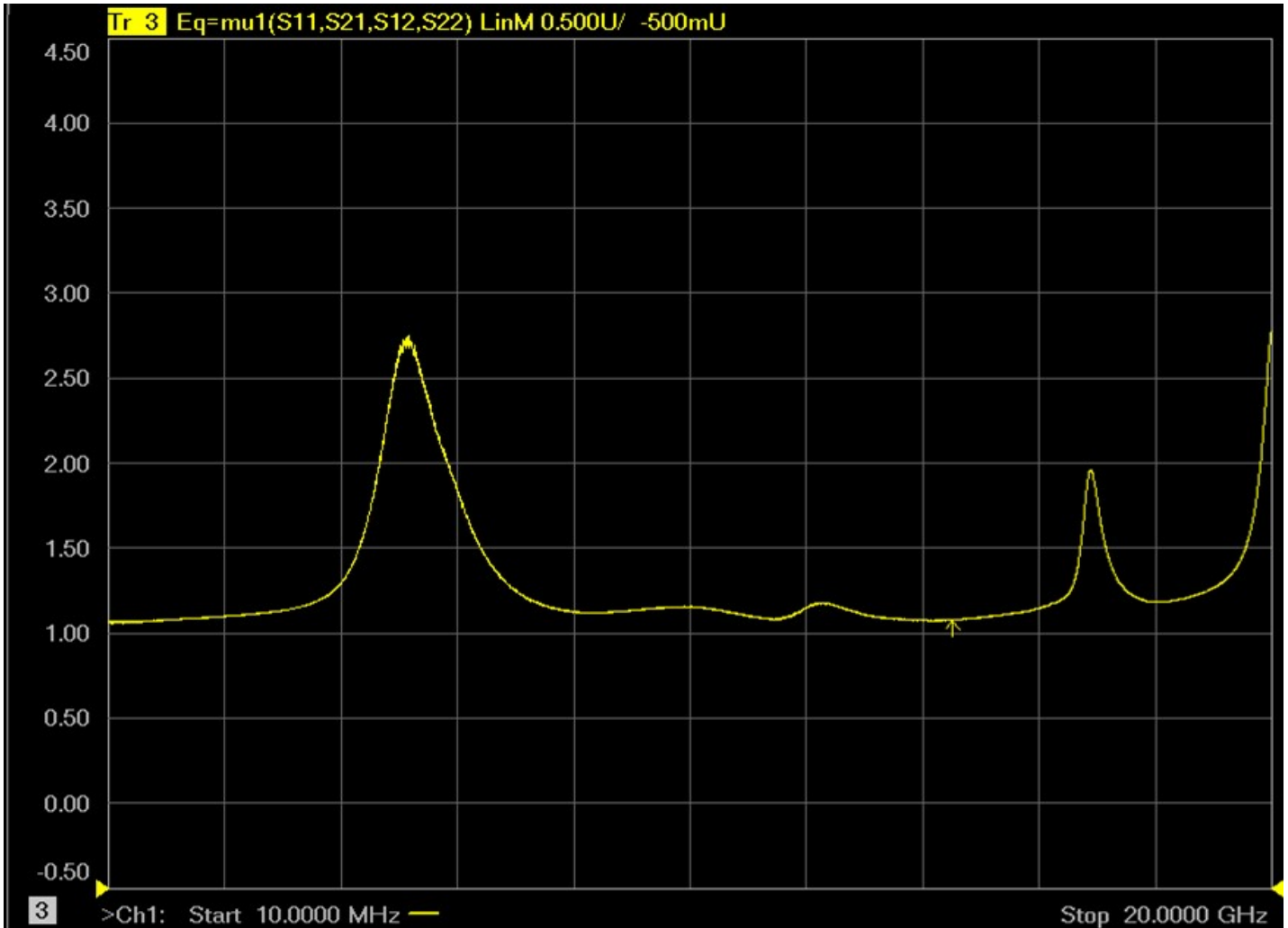

Note: $\mu \geq 1.0$ implies unconditional stability.

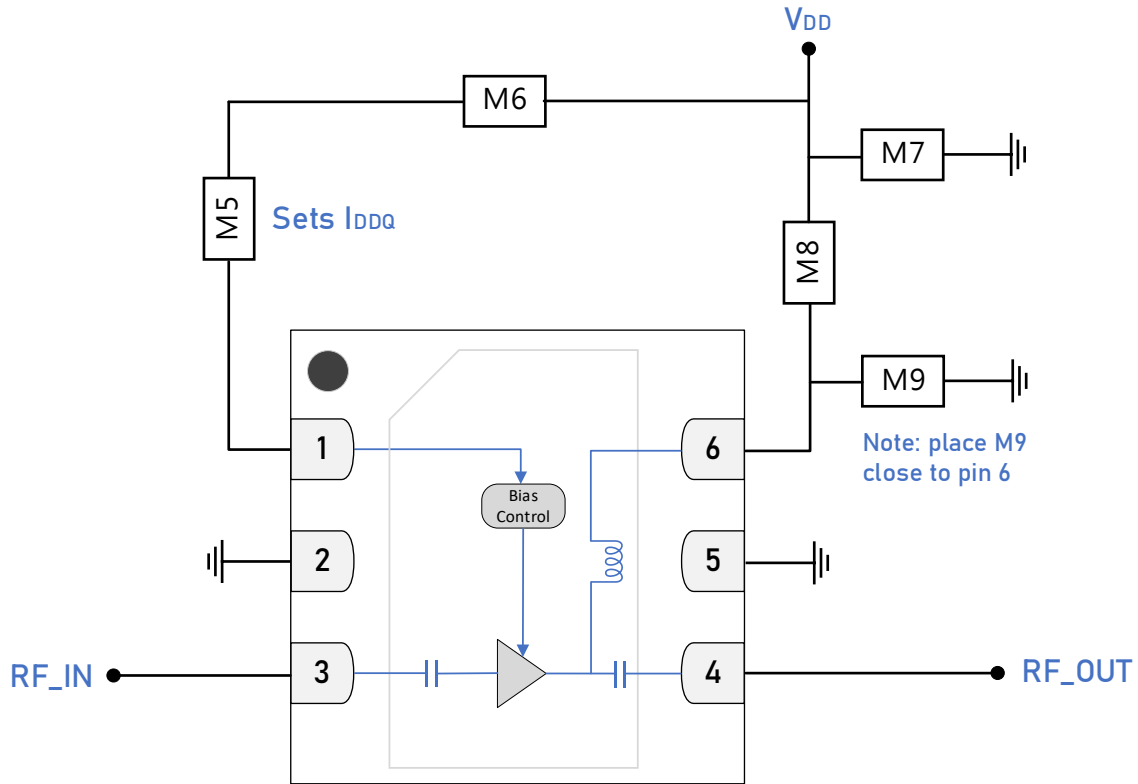

GRF2501 Standard Evaluation Board Schematic

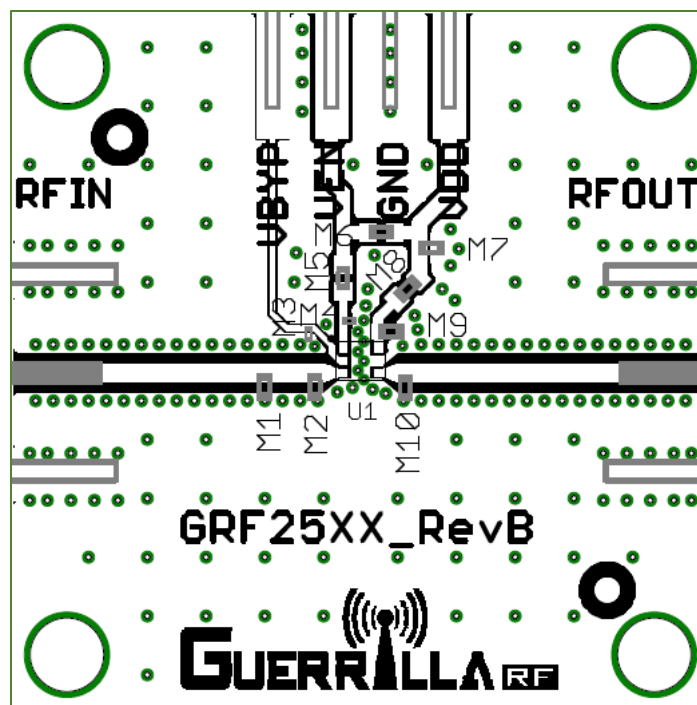

GRF2501 Evaluation Board Assembly Diagram

GRF2501 Evaluation Board Assembly Diagram Reference: 5.1 to 5.9 GHz Tune

Component	Type	Manufacturer	Family	Value	Package Size	Substitution
M5	Resistor (sets I _{DDQ})	Various	5%	1 kΩ	0201	ok
M6	Resistor (jumper)	Various	5%	0 Ω	0201	ok
M7	Capacitor	Murata	GRM	0.1 μF	0201	ok
M8	Ferrite Bead	Murata	BLM15AG121SN1D	120 Ω	0201	ok
M9 (see note)	Capacitor	Murata	GJM	1.0 pF	0201	ok
Evaluation Board	GRF25XX_RevB					

Note: Place M9 close to Pin 6. The position of this component affects the device matching.

GRF2501 Bias Resistor Selection Table: V_{DD} = 3.3 V

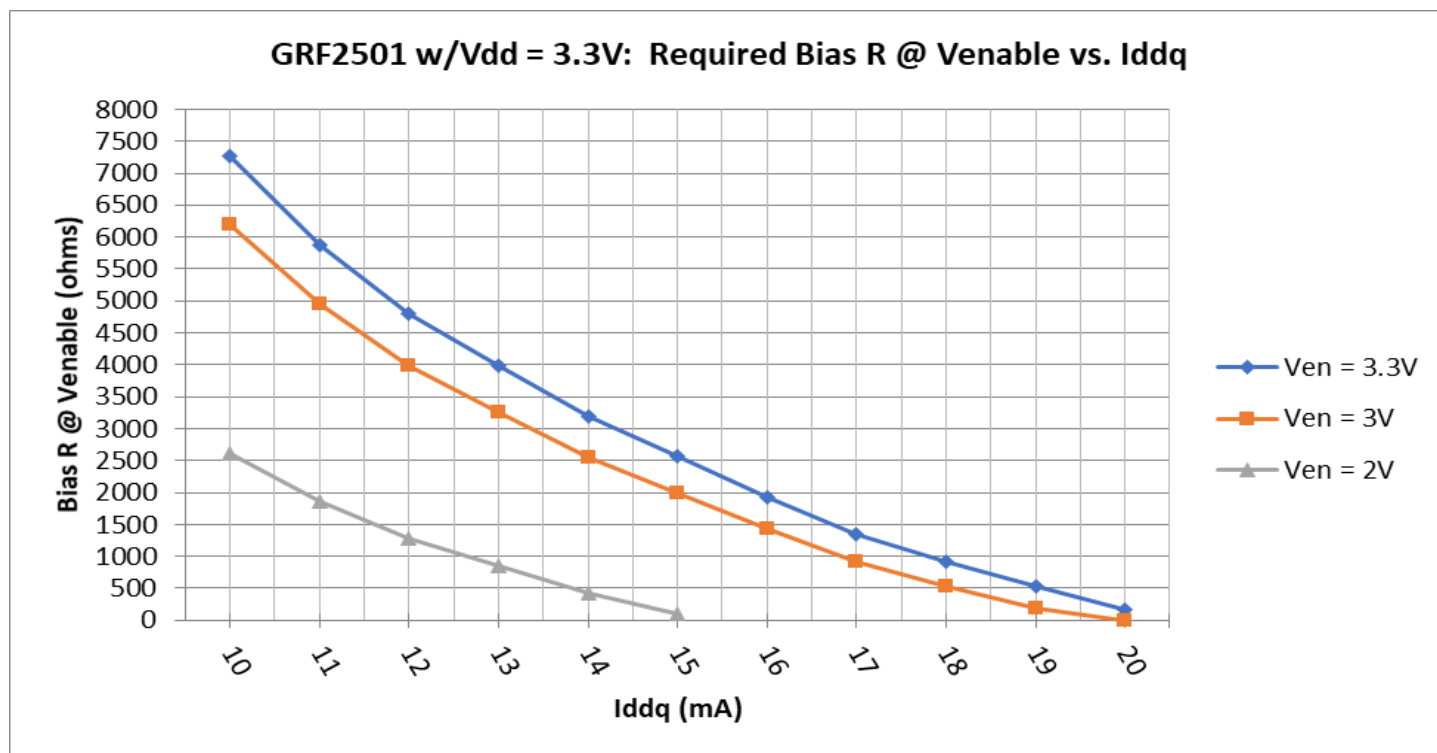

GRF2501 Bias Resistor Selection Table: $V_{DD} = 3\text{ V}$

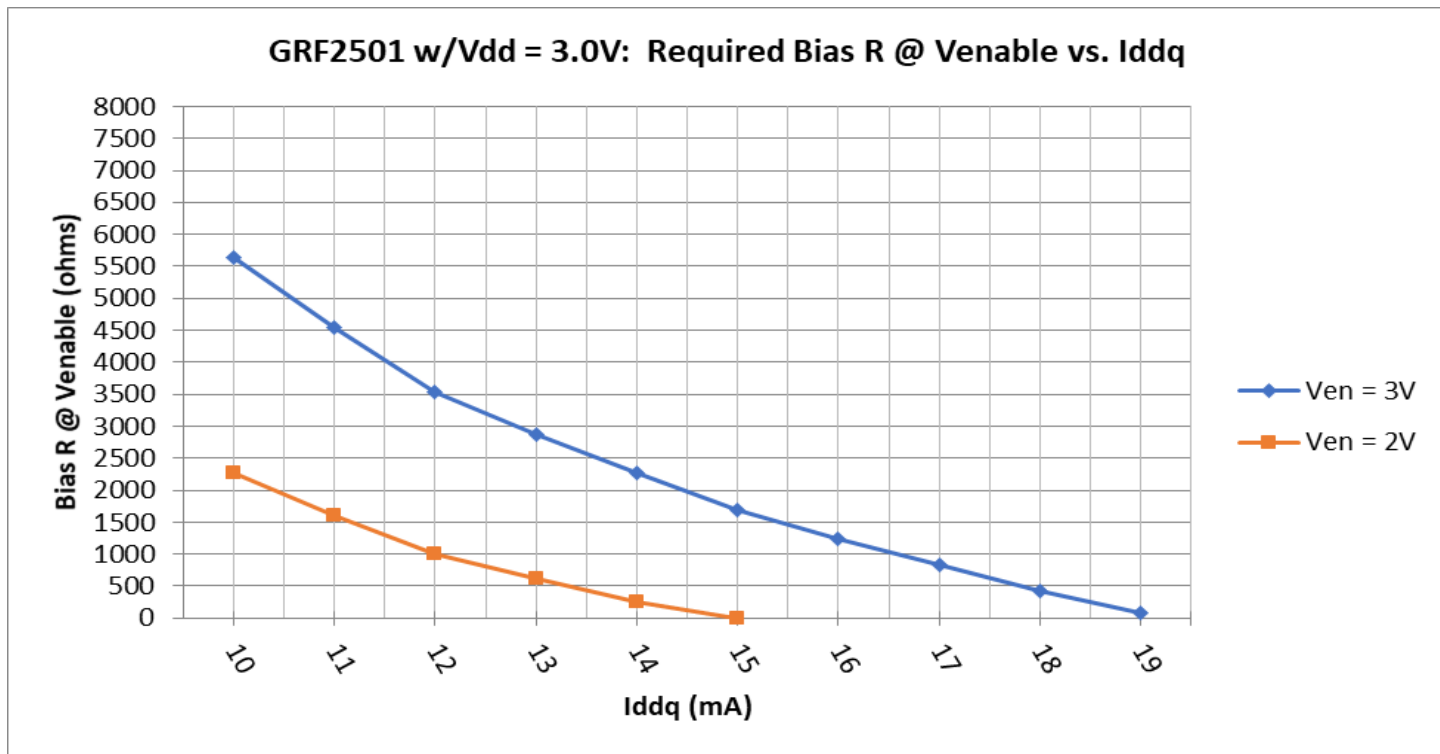

Bias Resistor Selection Table: $V_{DD} = 5\text{ V}$

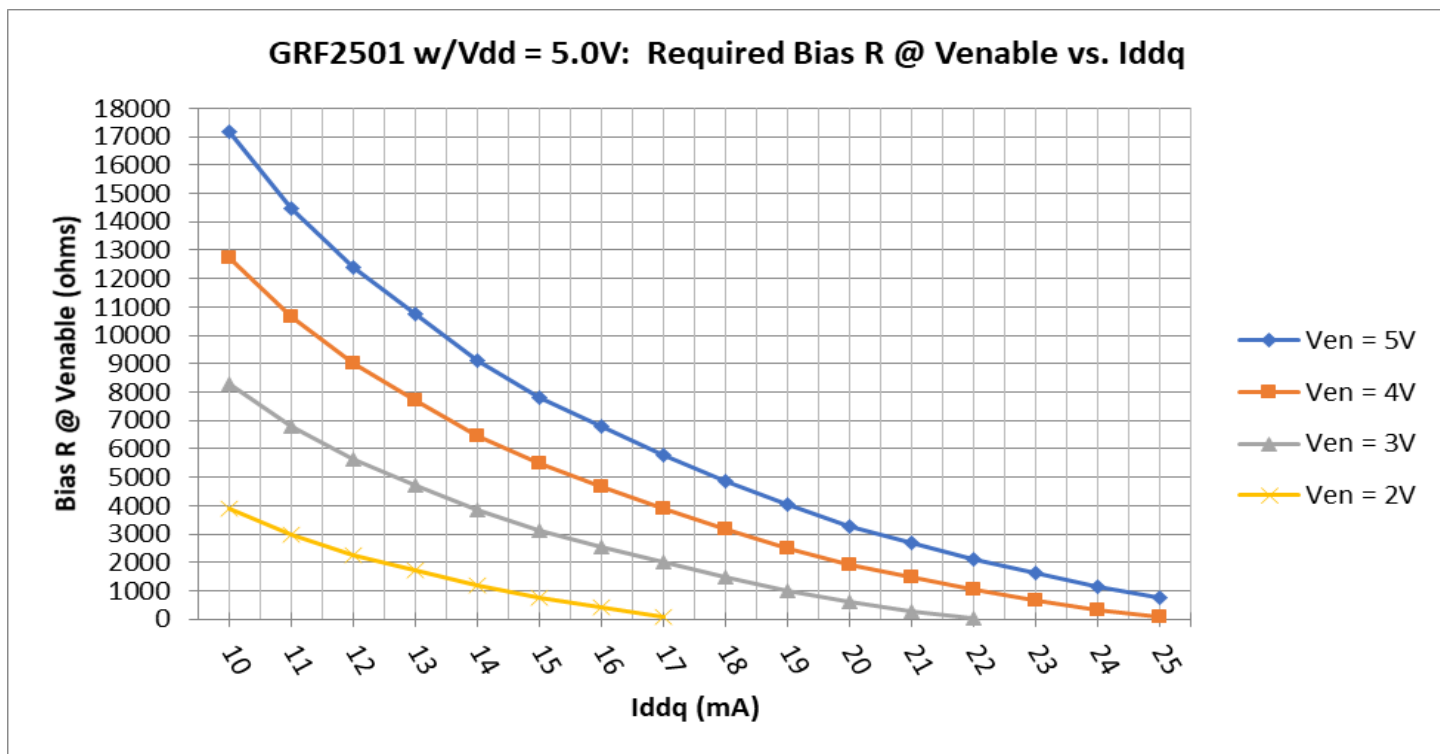

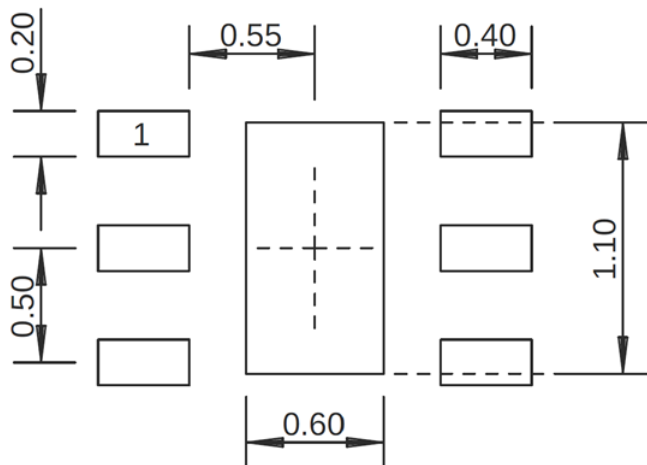

1.5 x 1.5 mm DFN-6 Suggested PCB Footprint (Top View)

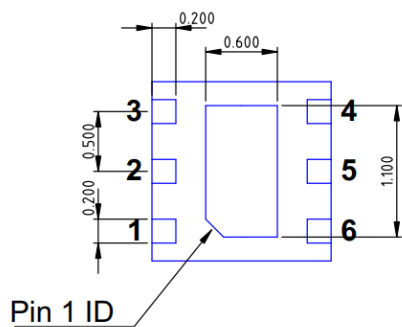

Bottom View

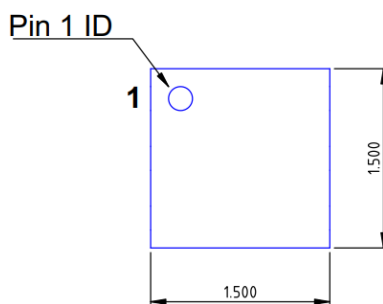

Top View

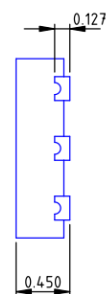

Side View

DFN6 1.5x1.5mm

Dimensions in millimeters
Dimensional Tolerance: ± 0.05

1.5 x 1.5 mm DFN-6 Package Dimensions

Package Marking Diagram



- Line 1: "Y" = YEAR (single digit). "WW" = WORK WEEK the Device was assembled.
- Line 2: "XXXX" = Device PART NUMBER.

Tape and Reel Information

Guerrilla RF's tape and reel specification complies with Electronic Industries Alliance (EIA) standards for "Embossed Carrier Tape of Surface Mount Components for Automatic Handling" (reference EIA-481). See the following page for the Tape and Reel Specification and Device Package Information table, which includes units per reel.

Devices are loaded with pins down into the carrier pocket with protective cover tape and reeled onto a plastic reel. Each reel is packaged in a cardboard box. There are product labels on the reel, the protective ESD bag and the outside surface of the box.

For the Tape and Reel Reference Table, please refer to: [Package Manufacturing Information | Guerrilla RF \(guerrilla-rf.com\)](#)

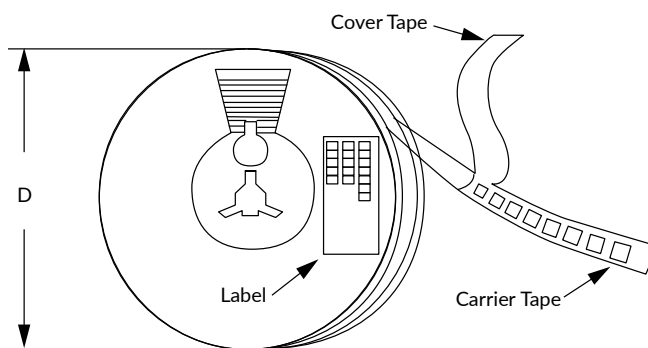

Tape and Reel Packaging with Reel Diameter Noted (D)

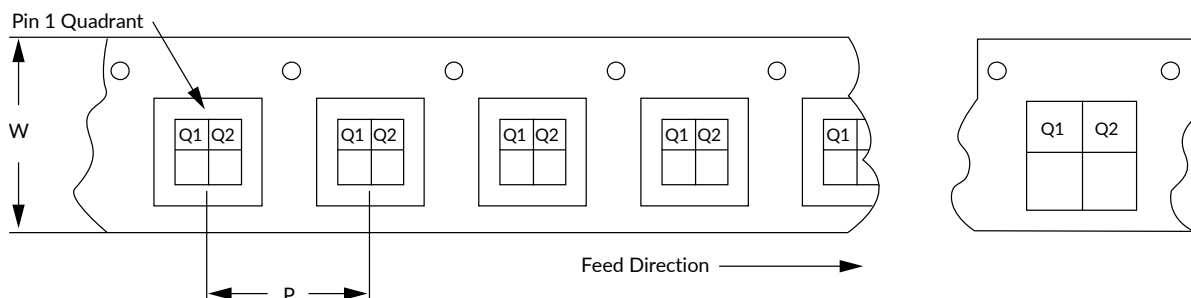

Carrier Tape Width (W), Pitch (P), Feed Direction and Pin 1 Quadrant Information



Revision History

Revision Date	Description of Change
May 10, 2017	Release Ø Data Sheet.
May 5, 2023	Release A Data Sheet. Upgraded Data Sheet to new format.
May 7, 2025	Extended minimum frequency from 4.9 GHz to 4.3 GHz.



Data Sheet Classifications

Data Sheet Status	Notes
Advance	S-parameter and NF data based on EM simulations for the fully packaged device using foundry-supplied transistor S-parameters. Linearity estimates based on device size, bias condition and experience with related devices.
Preliminary	All data based on limited evaluation board measurements taken within the Guerrilla RF Applications Lab. All parametric values are subject to change pending the collection of additional data.
Release Ø	All data based on measurements taken with <i>production-released</i> material. TYP values are based on a combination of ATE and bench-level measurements, with MIN/MAX limits defined using <i>modelled estimates</i> that account for part-to-part variations and expected process spreads. Although unlikely, future refinements to the TYP/MIN/MAX values may be in order as multiple lots are processed through the factory.
Release A-Z	All data based on measurements taken with production-released material <i>derived from multiple lots which have been fabricated over an extended period of time</i> . MIN/MAX limits may be refined over previous releases as more statistically significant data is collected to account for process spreads.

Information in this data sheet is specific to the Guerrilla RF, Inc. ("Guerrilla RF") product identified.

This data sheet, including the information contained in it, is provided by Guerrilla RF as a service to its customers and may be used for informational purposes only by the customer. Guerrilla RF assumes no responsibility for errors or omissions on this data sheet or the information contained herein. Information provided is believed to be accurate and reliable, however, no responsibility is assumed by Guerrilla RF for its use, nor for any infringement of patents, or other rights of third parties, resulting from its use. Guerrilla RF assumes no liability for any data sheet, data sheet information, materials, products, product information, or other information provided hereunder, including the sale, distribution, reproduction or use of Guerrilla RF products, information, or materials.

No license, whether express, implied, by estoppel, by implication or otherwise is granted by this data sheet for any intellectual property of Guerrilla RF, or any third party, including without limitation, patents, patent rights, copyrights, trademarks, and trade secrets. All rights are reserved by Guerrilla RF.

All information herein, products, product information, data sheets, and data sheet information are subject to change and availability without notice. Guerrilla RF reserves the right to change component circuitry, recommended application circuitry and specifications at any time without prior notice. Guerrilla RF may further change its data sheet, product information, documentation, products, services, specifications, or product descriptions at any time, without notice. Guerrilla RF makes no commitment to update any materials or information and shall have no responsibility whatsoever for conflicts, incompatibilities, or other difficulties arising from any future changes.

GUERRILLA RF INFORMATION, PRODUCTS, PRODUCT INFORMATION, DATA SHEETS AND DATA SHEET INFORMATION ARE PROVIDED "AS IS" AND WITHOUT WARRANTY OF ANY KIND, WHETHER EXPRESS, IMPLIED, STATUTORY, OR OTHERWISE, INCLUDING FITNESS FOR A PARTICULAR PURPOSE OR USE, MERCHANTABILITY, PERFORMANCE, QUALITY OR NON-INFRINGEMENT OF ANY INTELLECTUAL PROPERTY RIGHT; ALL SUCH WARRANTIES ARE HEREBY EXPRESSLY DISCLAIMED. GUERRILLA RF DOES NOT WARRANT THE ACCURACY OR COMPLETENESS OF THE INFORMATION, TEXT, GRAPHICS OR OTHER ITEMS CONTAINED WITHIN THESE MATERIALS. GUERRILLA RF SHALL NOT BE LIABLE FOR ANY DAMAGES, INCLUDING BUT NOT LIMITED TO ANY SPECIAL, INDIRECT, INCIDENTAL, STATUTORY, OR CONSEQUENTIAL DAMAGES, INCLUDING WITHOUT LIMITATION, LOST REVENUES OR LOST PROFITS THAT MAY RESULT FROM THE USE OF THE MATERIALS OR INFORMATION, WHETHER OR NOT THE RECIPIENT OF MATERIALS HAS BEEN ADVISED OF THE POSSIBILITY OF SUCH DAMAGE.

Customers are solely responsible for their use of Guerrilla RF products in the Customer's products and applications or in ways which deviate from Guerrilla RF's published specifications, either intentionally or as a result of design defects, errors, or operation of products outside of published parameters or design specifications. Customers should include design and operating safeguards to minimize these and other risks. Guerrilla RF assumes no liability or responsibility for applications assistance, customer product design, or damage to any equipment resulting from the use of Guerrilla RF products outside of stated published specifications or parameters.