

Data Sheet | Item Number: 294-5012

Lighting connector; push-button, external; without ground contact; 2-pole; Lighting side: for solid conductors; Inst. side: for all conductor types; max. 2.5 mm²; Surrounding air temperature: max 85°C (T85); white

<https://www.wago.com/294-5012>

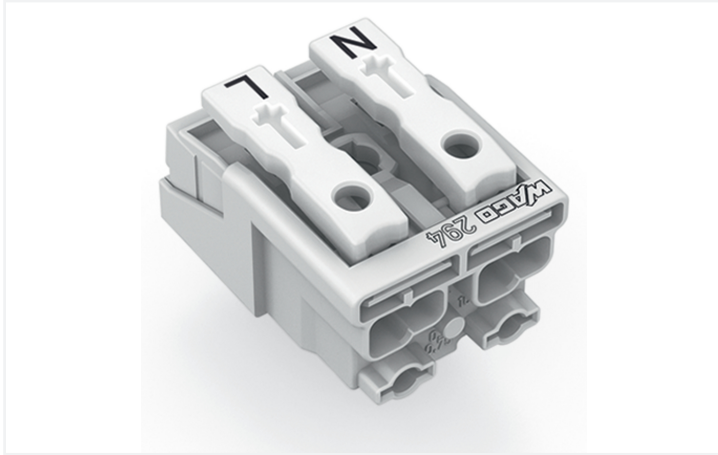

Color: ■ white

Similar to illustration

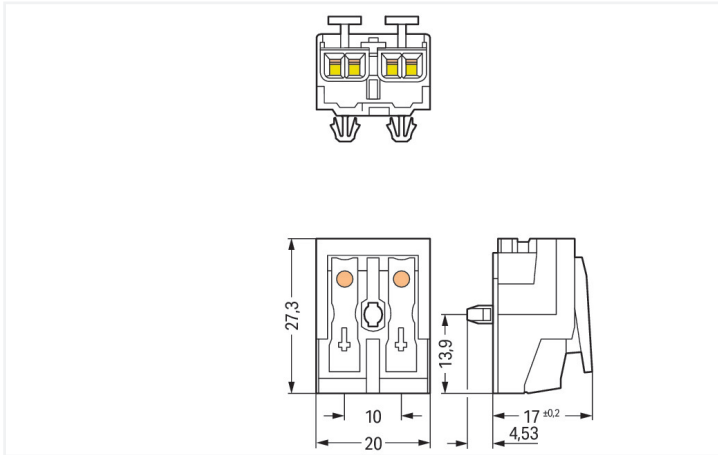

Dimensions in mm

Field-wiring terminal block, 294 Series, push-button

Connecting conductors is quick and easy with this field-wiring terminal block (item number 294-5012). Conductors should only be connected to this field-wiring terminal block if their strip length is between 8 and 9 mm. Featuring four conductor terminals along with Push-in CAGE CLAMP® as well as PUSH WIRE®, this product delivers reliable performance. Our Push-in CAGE CLAMP® is a universal, maintenance-free connection solution for all conductor types, boasting a key feature: both solid and fine-stranded conductors with ferrules can be directly inserted without the need for tools or any preparation, such as crimping the ferrule. Our PUSH WIRE® connection offers a quick and simple solution for connecting solid conductors. Dimensions: (20 x 21.53 x 27.3) mm (width x height x depth). Depending on the type of conductor, this field-wiring terminal block is designed for conductor cross sections ranging from 0.5 mm² to 2.5 mm² on one side and for conductor cross sections from 0.5 mm² to 2.5 mm² on the other side as well as conductor cross sections from 0.5 mm² to 1.5 mm² and from 0.5 mm² to 0.75 mm².

Tin is used for coating the contact surfaces.

Electrical data

Ratings per	IEC/EN 60998-1		
Overvoltage category	III	III	II
Pollution degree	3	2	2
Nominal voltage	-	-	500 V
Rated impulse withstand voltage	-	-	4 kV
Rated current	-	-	24 A

Ratings per IEC/EN – Notes

Ratings (note)	Connection points
----------------	-------------------

Ratings per	IEC/EN 60998-2-2		
Overvoltage category	III	III	II
Pollution degree	3	2	2
Nominal voltage	-	-	500 V
Rated impulse withstand voltage	-	-	4 kV
Rated current	-	-	24 A

General information

Wiring direction	Side-entry wiring
------------------	-------------------

Connection Data

Clamping units	10
Total number of potentials	2
Number of connection types	4
PE function	without PE contact

Connection 1

Connection type	External 1
Connection technology	Push-in CAGE CLAMP®
Number of connection points	2
Actuation type	Push-button
Connectable conductor materials	Copper
Solid conductor	0.5 ... 2.5 mm ² / 18 ... 12 AWG
Solid conductor; push-in termination	0.5 ... 2.5 mm ² / 18 ... 12 AWG
Stranded conductor	0.5 ... 2.5 mm ² / 18 ... 14 AWG
Fine-stranded conductor	0.5 ... 2.5 mm ² / 18 ... 14 AWG
Fine-stranded conductor; with insulated ferrule	0.5 ... 1.5 mm ² / 18 ... 16 AWG
Fine-stranded conductor; with uninsulated ferrule	0.5 ... 1.5 mm ² / 18 ... 16 AWG
Fine-stranded conductor; with ferrule; push-in termination	0.5 mm ² / 18 AWG
Strip length	8 ... 9 mm / 0.31 ... 0.35 inches
Pole number	2
Wiring direction	Side-entry wiring

Connection 2

Connection type	Internal 2
Connection technology	PUSH WIRE®
Number of connection points	1
Actuation type	Push-in
Solid conductor	0.5 ... 2.5 mm ² / 18 ... 14 AWG
Fine-stranded conductor; with insulated ferrule	0.5 ... 1 mm ² / 18 ... 16 AWG
Fine-stranded conductor; with uninsulated ferrule	0.5 ... 1.5 mm ² / 18 ... 14 AWG
Strip length	8 ... 9 mm / 0.31 ... 0.35 inches

Connection 3

Connection type	Internal 3
Connection technology	PUSH WIRE®
Number of connection points	1
Actuation type	Push-in
Solid conductor	0.5 ... 1.5 mm ² / 18 ... 16 AWG
Fine-stranded conductor; with insulated ferrule	0.5 ... 0.75 mm ² / 18 AWG
Fine-stranded conductor; with uninsulated ferrule	0.5 ... 1 mm ² / 18 AWG
Strip length	8 ... 9 mm / 0.31 ... 0.35 inches

Connection 4

Connection type	Internal 4
Connection technology	PUSH WIRE®
Number of connection points	1
Actuation type	Push-in
Solid conductor	0.5 ... 0.75 mm ² / 18 AWG
Strip length	8 ... 9 mm / 0.31 ... 0.35 inches

Physical data

Pin spacing	10 mm / 0.394 inches
Width	20 mm / 0.787 inches
Height	21.53 mm / 0.848 inches
Height from the surface	17 mm / 0.669 inches
Depth	27.3 mm / 1.075 inches

Mechanical data

Marking	N-L
Mounting type	Snap-in foot

Material data

Note (material data)	Information on material specifications can be found here
Color	white
Material group	IIIa
Insulation material (main housing)	Polycarbonate (PC)
Flammability class per UL94	V0
Clamping spring material	Chrome-nickel spring steel (CrNi)
Contact material	Electrolytic copper (E _{Cu})
Contact Plating	Tin
Fire load	0.094 MJ
Halogen-free	Yes
Weight	6.4 g

Environmental requirements

Temperature stability	120 °C
T marking	T85

Commercial data

Product Group	8 (Misc. Chassis Mount Blocks)
PU (SPU)	1000 pcs
Packaging type	Foil
Country of origin	CH
GTIN	4050821020752
Customs tariff number	85369010000

Product Classification	
UNSPSC	39121409
eCl@ss 10.0	27-14-11-06
eCl@ss 9.0	27-14-11-06
ETIM 9.0	EC001284
ETIM 10.0	EC001284
ECCN	NO US CLASSIFICATION

Environmental Product Compliance	
REACH Candidate List Substance	Perfluorobutane sulfonic acid (PFBS) and its salts
RoHS Compliance Status	Compliant, No Exemption
SCIP notification number (Austria)	fe561efa-f88e-4875-8540-6170797db38e
SCIP notification number (Belgium)	8c1ca12a-780a-4638-a19f-361733568c09
SCIP notification number (Bulgaria)	f8baf527-5f53-4bef-be75-25ca516c736f
SCIP notification number (Czech Republic)	1e845d7a-8c5f-424c-a1e6-0a2b675f148d
SCIP notification number (Denmark)	d5002d8d-06de-4852-97dc-e7d6e6e4f714
SCIP notification number (Finland)	8b2f4816-f103-4eef-b8ab-c7deea887cc5
SCIP notification number (France)	6a644177-c05a-4b1e-8460-3a8fcc60c0b9
SCIP notification number (Germany)	031d86d1-7a65-49db-8fd6-a5967e538347
SCIP notification number (Hungary)	fa329490-a063-41b9-b8e8-33cdeac61a33
SCIP notification number (Italy)	a5bfc278-45b1-43e9-8309-7e84d6963386
SCIP notification number (Netherlands)	64956883-9dbf-4840-8ee3-da32c88650e1
SCIP notification number (Poland)	748d0b91-656a-46c4-94a3-235340d064a6
SCIP notification number (Romania)	86667701-deb4-402f-98fd-a463024e456e
SCIP notification number (Sweden)	c15151a1-1668-4550-ae83-b9b48c4d8c9e

Approvals / Certificates

General approvals			Declarations of conformity and manufacturer's declarations		
Approval	Standard	Certificate Name	Approval	Standard	Certificate Name
ENEC 05 DEKRA Certification B.V.	EN 60998	2128791.01	EU-Declaration of Confor- mity WAGO GmbH & Co. KG	-	-
			UK-Declaration of Confor- mity WAGO GmbH & Co. KG	-	-

Downloads

Environmental Product Compliance	
Compliance Search	
Environmental Product Compliance 294-5012	↓

Documentation

Bid Text			
294-5012	19.02.2019	xml 5.57 KB	
294-5012	13.06.2017	doc 27.00 KB	

CAD/CAE-Data

CAD data	
2D/3D Models 294-5012	

CAE data	
WSCAD Universe 294-5012	
ZUKEN Portal 294-5012	

1 Compatible Products

1.1 Optional Accessories

1.1.1 Strain relief

1.1.1.1 Strain relief



Item No.: 294-370

Strain relief; for 294 Series; with snap-in mounting feet; white

Item No.: 294-375

Strain relief; for 294 Series; without snap-in mounting feet; white

1.1.1.2 Strain relief plate



Item No.: 294-364

Strain relief plate; for 294 Series; for multi-core cables; 3- to 5-pole; with secured clamp; white

Item No.: 294-384

Strain relief plate; for 294 Series; for single strands; 3- to 5-pole; with secured clamp; white

1.1.2 Tool

1.1.2.2 Operating tool



Item No.: 206-294

Disconnection tool; green

Installation Notes

Installation

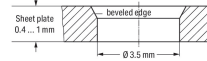
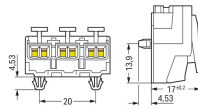
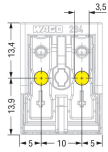

2-pole – without ground contact

Snap-in foot

Drilled hole for snap-in mounting foot

Conductor termination

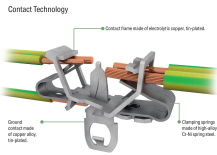

EUROPE
1 x 0.5 ... 2.5 mm ² "s"
1 x 0.5 ... 1.5 mm ² "s"
1 x 0.5 ... 0.75 mm ² "s"
AMERICA
1 x AWG 18 ... 14 "s"
1 x AWG 18 ... 16 "s"
1 x AWG 18 "s"
JAPAN
1 x 0.8 ... 1.6 mm diam. "s"
1 x 0.8 ... 1 mm diam. "s"
1 x 0.8 mm diam. "s"

EUROPE
2 x 0.5 ... 2.5 mm ² "s, str, f-str"
AMERICA
2 x AWG 18 ... 12 "s"
2 x AWG 18 ... 14 "s, f-str"
JAPAN
2 x 0.8 ... 2 mm diam. "s"
2 x 0.5 ... 2 mm ² str, f-str"

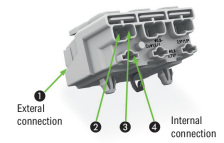

Internal connection:
PUSH WIRE® for internal wiring with solid conductors

External connection:
Push-in CAGE CLAMP® for field-wiring with all conductor types

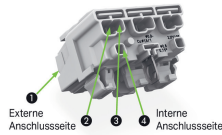

Terminating five conductors per pole – solid and fine-stranded.

