

DESCRIPTION

The MP9488 is a 7.5V to 450V, wide input, 300mA, step-down converter. The MP9488 is typically used in buck topology, but it can also support buck boost, boost, and flyback topology applications, even if the power supply range is very wide.

The MP9488 employs peak-current and variable-off-time control modes to regulate the output voltage. It integrates a high-voltage start-up circuit and one 500V MOSFET. The very simple structure helps achieve low cost and high input voltage. In light-load condition, the MP9488 peak current and switching frequency decrease as the load decreases, achieving high efficiency. This makes the MP9488 ideal for scooters, E-bikes, and other civil applications.

Full protection features include thermal shutdown, VCC under-voltage lockout (UVLO), overload protection (OLP), short-circuit protection (SCP), and open-loop protection.

The MP9488 is available in a SOIC-8 package.

FEATURES

- 7.5V to 450V Wide Input Range
- Integrated 500V MOSFET
- >500mA Switching Current Limit
- Peak-Current and Variable Off-Time Control
- Low VCC Operating Current
- Frequency Foldback
- Limited Maximum Frequency
- Peak Current Compression in Light Load
- Internal High-Voltage Current Source
- Thermal Shutdown (Auto-Restart)
- VCC Under-Voltage Lockout (UVLO) with Hysteresis
- Timer-Based Overload Protection (OLP)
- Short-Circuit Protection (SCP)
- Open-Loop Protection

APPLICATIONS

- Scooter and E-Bike Control Power Supplies
- Solar Energy Systems
- Automotive System Power
- Industrial Power Supplies

All MPS parts are lead-free, halogen-free, and adhere to the RoHS directive. For MPS green status, please visit the MPS website under Quality Assurance. "MPS" and "The Future of Analog IC Technology" are registered trademarks of Monolithic Power Systems, Inc.

TYPICAL APPLICATION

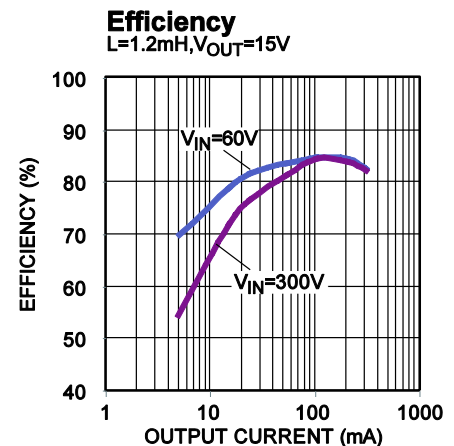
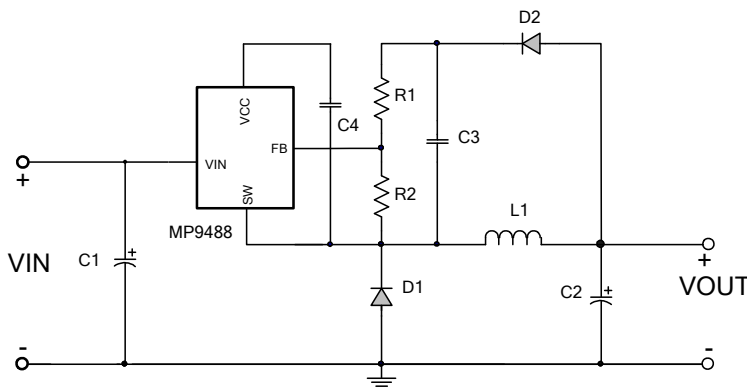

ORDERING INFORMATION

Part Number*	Package	Top Marking
MP9488GS	SOIC-8	See Below

* For Tape & Reel, add suffix -Z (e.g. MP9488GS-Z)

TOP MARKING

MP9488
LLLLLLLL
MPSYWW

MP9488: Part number
 LLLLLLLL: Lot number
 MPS: MPS prefix
 Y: Year code
 WW: Week code

PACKAGE REFERENCE

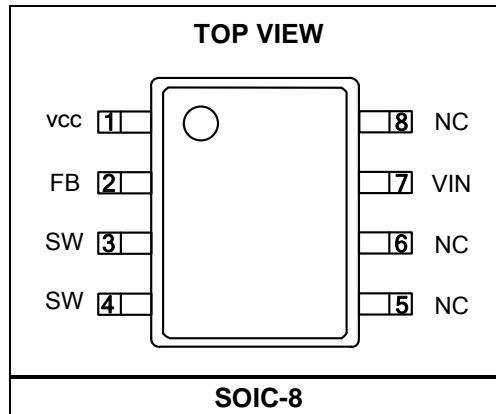

ABSOLUTE MAXIMUM RATINGS ⁽¹⁾

VIN to SW -0.3V to 500V
 All other pins to SW -0.3V to 6.5V
 Continuous power dissipation (T_A = +25°C) ⁽²⁾
 1.3W
 Junction temperature 150°C
 Lead temperature 260°C
 Storage temperature -65°C to +150°C

Recommended Operating Conditions ⁽³⁾

Supply VIN to SW voltage 7.5V to 450V
 Operating VCC range 4.45V to 4.6V ⁽⁴⁾
 Operating junction temp. (T_J) .. -40°C to +125°C

Thermal Resistance ⁽⁵⁾	θ_{JA}	θ_{JC}
SOIC-8	96	45 ... °C/W

NOTES:

- Exceeding these ratings may damage the device.
- The maximum allowable power dissipation is a function of the maximum junction temperature T_J (MAX), the junction-to-ambient thermal resistance θ_{JA} , and the ambient temperature T_A. The maximum allowable continuous power dissipation at any ambient temperature is calculated by P_D (MAX) = (T_J (MAX)-T_A)/ θ_{JA} . Exceeding the maximum allowable power dissipation produces an excessive die temperature, causing the regulator to go into thermal shutdown. Internal thermal shutdown circuitry protects the device from permanent damage.
- The device is not guaranteed to function outside of its operating conditions.

- 4) See the Start-Up and Under-Voltage Lockout section on page 10 for more detail.
- 5) Measured on JESD51-7, 4-layer PCB.

ELECTRICAL CHARACTERISTICS

VCC = 5V, T_A = 25°C, unless otherwise noted.

Parameter	Symbol	Condition	Min	Typ	Max	Units
Start-Up Current Source (VIN)						
Internal regulator supply current	I _{regulator}	VCC = 4V, VIN = 100V	2.5	3.5	5.5	mA
Leakage current from VIN	I _{Leak}	VCC = 5V, VIN = 400V		10	25	μA
Break-down voltage between VIN and SW	V _{(BR)DSS}		500			V
Supply Voltage Management (VCC)						
VCC increasing level at which the internal regulator stops	VCC _{OFF}		4.5	4.6	4.9	V
VCC decreasing level at which the internal regulator turns on	VCC _{ON}		4.3	4.45	4.7	V
VCC regulator on and off hysteresis				230		mV
VCC decreasing level at which the IC stops working	VCC _{stop}		3.2	3.35	3.5	V
VCC decreasing level at which the protection phase ends	VCC _{pro}		2.05	2.35	2.65	V
Internal IC consumption	I _{CC}	VCC = 4.6V, F _S = 45kHz, duty = 40%			500	μA
Internal IC consumption (no switch)	I _{CC}	VCC = 4.6V			165	μA
VCC discharge current during protection		VCC = 5V		16		μA
Internal MOSFET (VIN)						
Break-down voltage	V _{BRDSS}		500			V
On-state resistance	R _{on}			10		Ω
Internal Current Sense						
Peak current limit	I _{Limit}		500	640	780	mA
Leading edge blanking	T _{LEB1}			400		ns
SCP point	I _{SCP}			900	1200	mA
Leading edge blanking for SCP ⁽⁶⁾	T _{LEB2}			180		ns
Feedback Input (FB)						
Minimum off time	T _{minoff}		10.6	13.1	15.6	μs
Feedback threshold to turn on the primary MOSFET	V _{FB}		2.45	2.55	2.65	V
Feedback threshold to trigger OLP	V _{FB_OLP}		1.6	1.7	1.8	V
Overload protection delay time	T _{OLP}	F _S = 37kHz		150		ms
Open-loop detection	V _{OLD}			60		mV
Thermal Shutdown						
Thermal shutdown threshold ⁽⁶⁾				150		°C

NOTE:

6) Guaranteed by characterization.

TYPICAL CHARACTERISTICS

Break-Down Voltage vs. Temperature

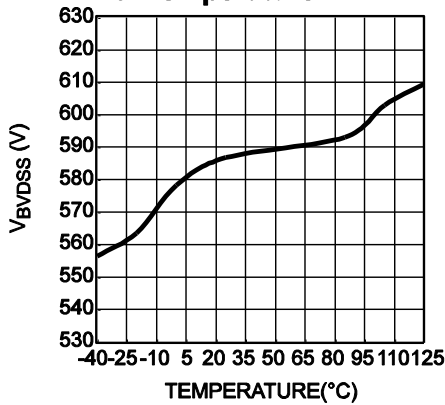

On-State Resistance vs. Temperature

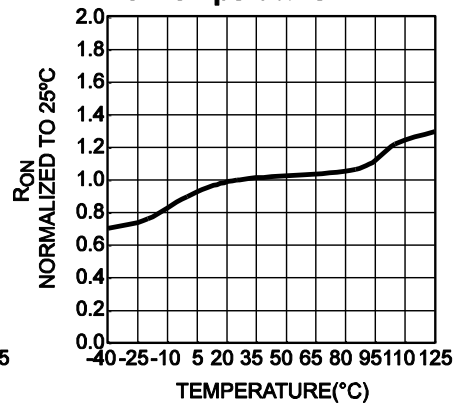

Feedback Threshold vs. Temperature

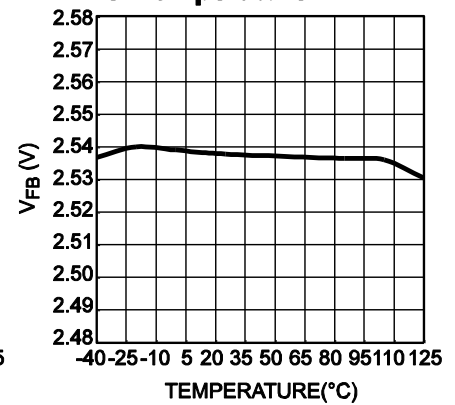

VCC Increasing Level at Which the Internal Regulator Stops vs. Temperature

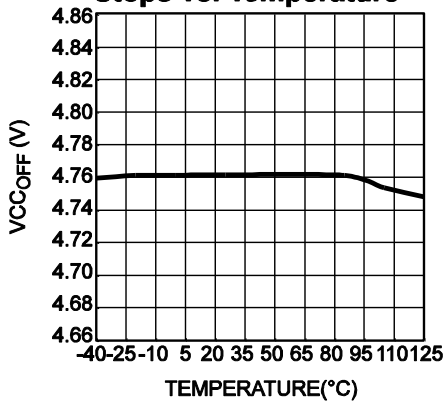

VCC Decreasing Level at Which the Internal Regulator Turns On vs. Temperature

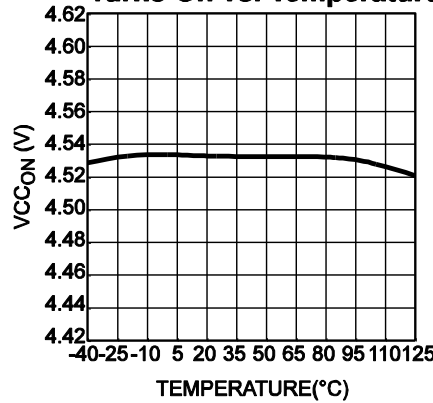

VCC Decreasing Level at Which the Protection Phase Ends vs. Temperature

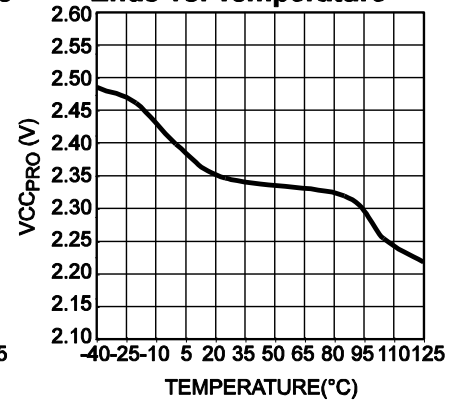

Minimum Off Time vs. Temperature

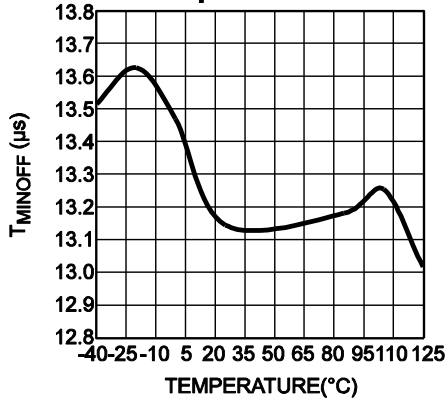

Peak Current Limit vs. Temperature

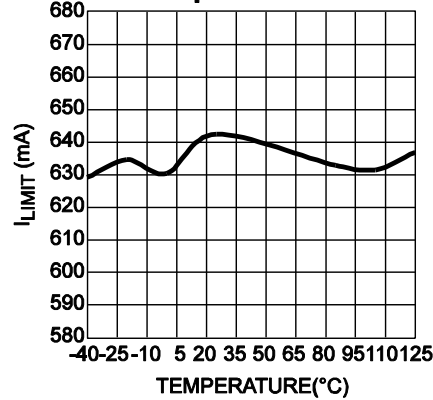

SCP Point vs. Temperature

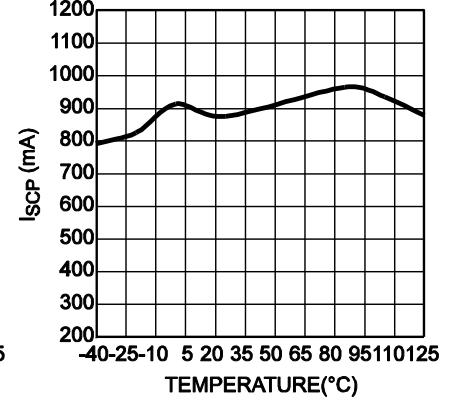

TYPICAL PERFORMANCE CHARACTERISTICS

$V_{IN} = 60V$, $V_{OUT} = 15V$, $I_{OUT} = 300mA$, $L = 1.2mH$, $C_{OUT} = 100\mu F$, $T_A = +25^\circ C$, unless otherwise noted.

Efficiency
 $L=1.2mH$

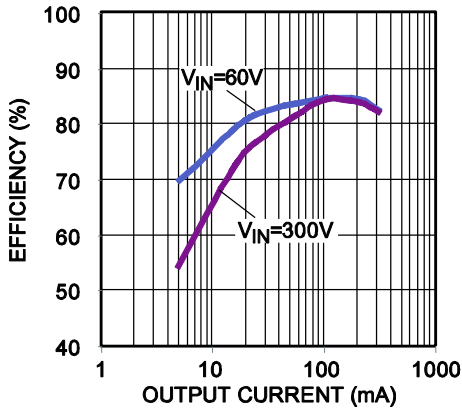

Load Regulation

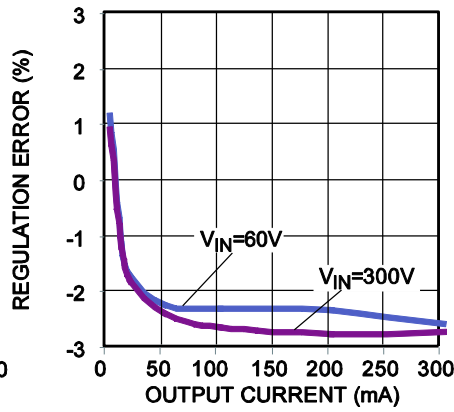

Line Regulation

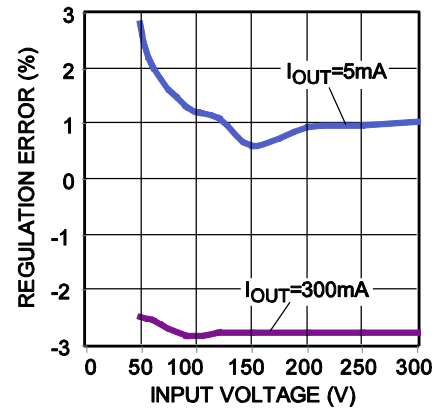

Case Temperature Rise

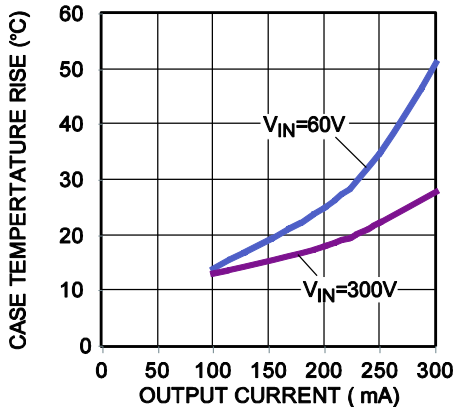

TYPICAL PERFORMANCE CHARACTERISTICS (continued)

$V_{IN} = 60V$, $V_{OUT} = 15V$, $I_{OUT} = 300mA$, $L = 1.2mH$, $C_{OUT} = 100\mu F$, $T_A = +25^\circ C$, unless otherwise noted.

Steady State
 $I_{OUT} = 5mA$

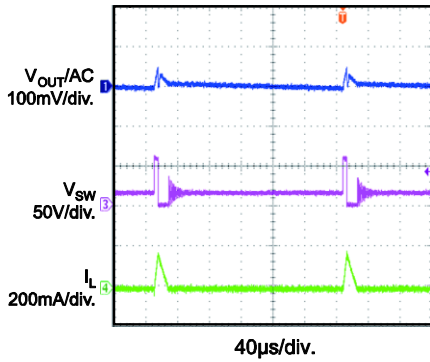

Steady State
 $I_{OUT} = 300mA$

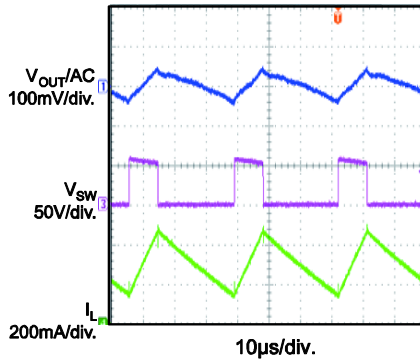

Power On
 $I_{OUT} = 5mA$

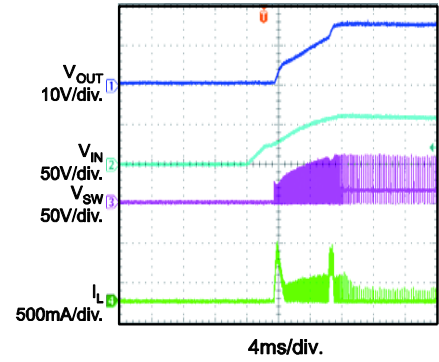

Power On
 $I_{OUT} = 300mA$

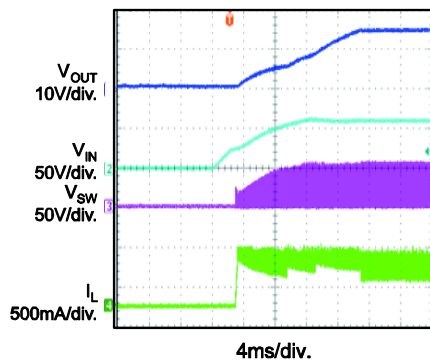

Power Off
 $I_{OUT} = 5mA$

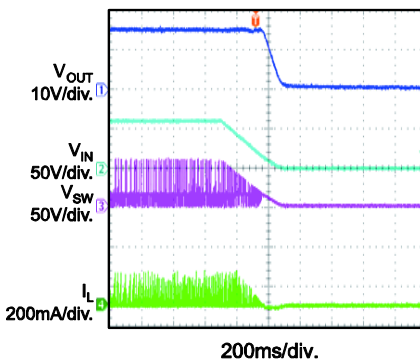

Power Off
 $I_{OUT} = 300mA$

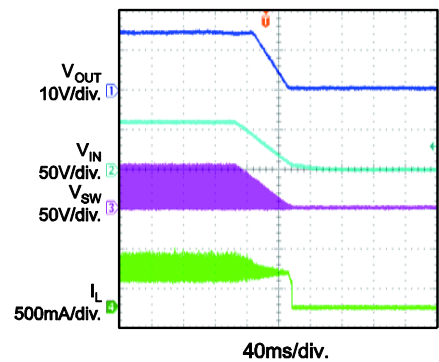

SCP Entry

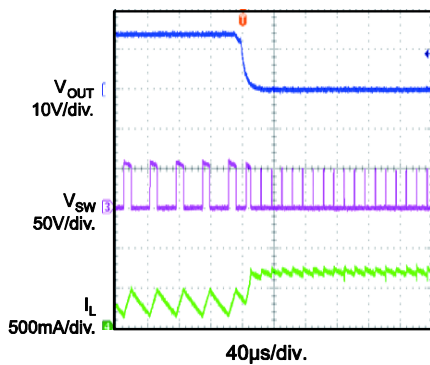

SCP Steady State

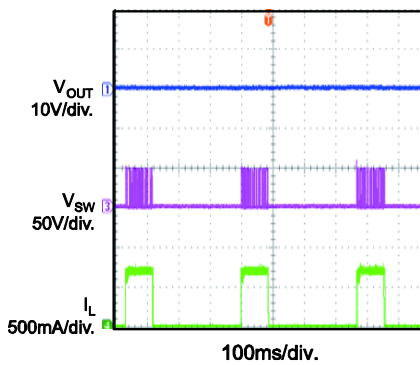

SCP Recovery

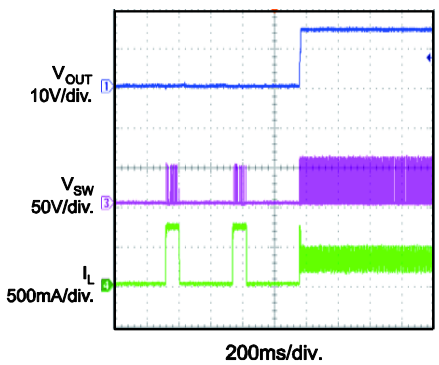

TYPICAL PERFORMANCE CHARACTERISTICS (continued)

$V_{IN} = 60V$, $V_{OUT} = 15V$, $I_{OUT} = 300mA$, $L = 1.2mH$, $C_{OUT} = 100\mu F$, $T_A = +25^\circ C$, unless otherwise noted.

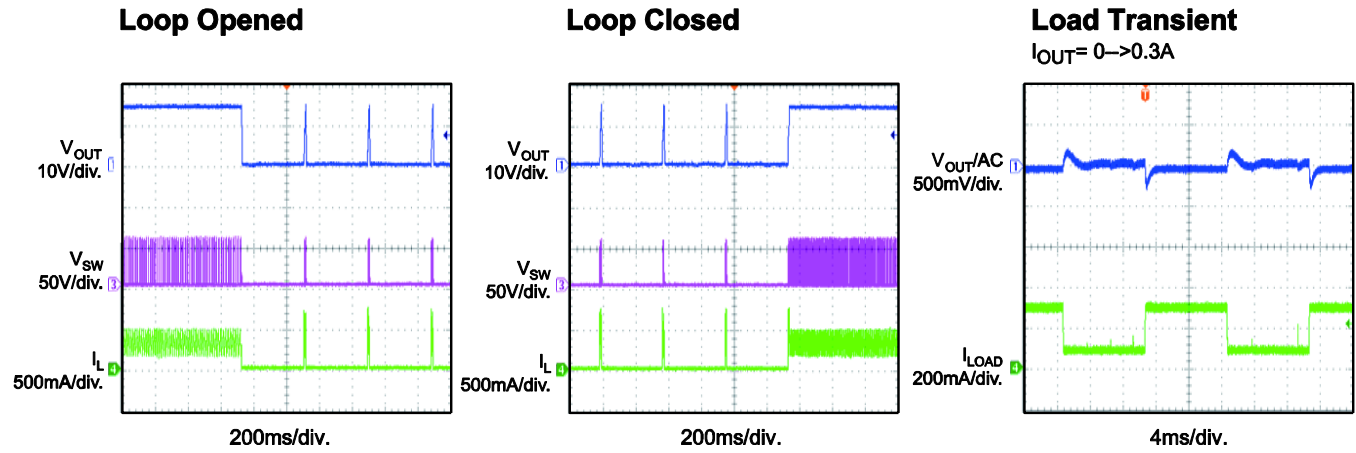

PIN FUNCTIONS

Pin#	Name	Description
1	VCC	Power supply of all control circuits.
2	FB	Feedback of the regulator.
3, 4	SW	Source of the internal power MOSFET. SW is the ground reference for VCC and FB.
5, 6, 8	NC	Not connected.
7	VIN	Drain of the internal power MOSFET. VIN is the input of the high-voltage current source.

BLOCK DIAGRAM

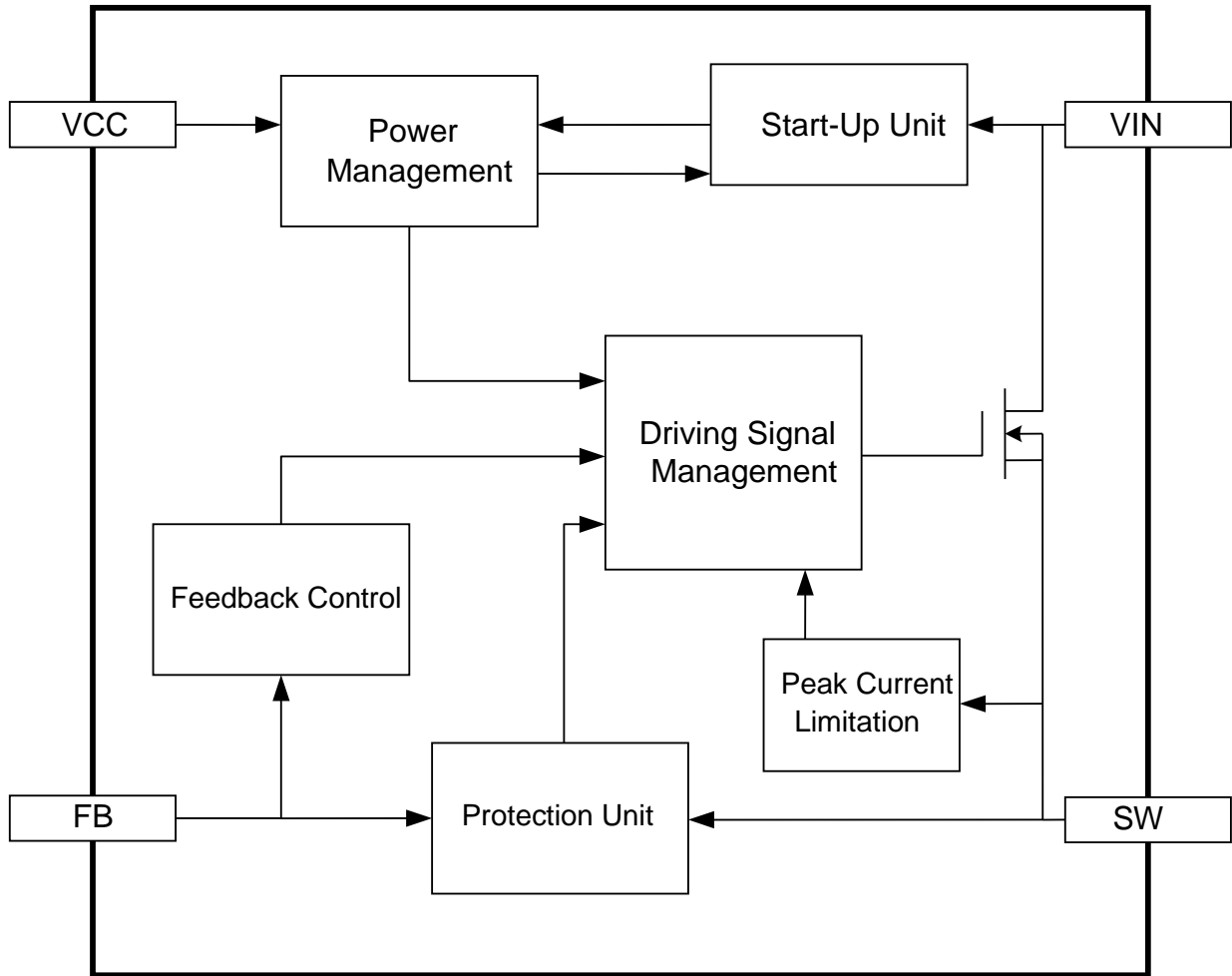

Figure 1: Functional Block Diagram

OPERATION

The MP9488 is a green-mode operation regulator. When the load decreases, the peak current and the switching frequency both decrease as well, resulting in excellent efficiency performance at light load and better average efficiency. The regulator is designed to operate with a minimum number of external components.

Start-Up and Under Voltage Lockout (UVLO)

The internal high-voltage regulator self-supplies the IC from VIN. The IC begins switching, and the internal high-voltage regulator turns off once the voltage on VCC reaches VCC_{OFF} (typically 4.6V). The internal high-voltage regulator turns on to charge the external VCC capacitor when the VCC voltage decreases below VCC_{ON} (typically 4.45V). VCC is self-regulated to a suitable value.

Due to the on/off discharge logic on VCC, a small capacitor is needed to maintain the voltage. It is also recommended to supply VCC from an external power such as V_{OUT} to decrease regulator power loss. In this case, if the external power voltage is higher than 4.8V, which is the threshold of the VCC internal clamping circuit (typically 4.8V, the clamp voltage is about 0.2V higher than VCC_{OFF}), the regulator's current should be limited below 2mA.

When the voltage on VCC drops below VCC_{stop} (typically 3.35V), the IC stops working.

When a fault condition occurs (such as OLP, SCP, or OTP), the IC stops working, and an internal current source (around 16μA) discharges the VCC capacitor. Before VCC drops below VCC_{pro} (typically 2.35V), the internal high-voltage regulator does not start to charge the VCC capacitor again. When the fault condition occurs, the restart time can be calculated by Equation (1):

$$t_{\text{restart}} = C_{\text{VCC}} \times \frac{V_{\text{CC}} - 2.35\text{V}}{16\mu\text{A}} + C_{\text{VCC}} \times \frac{4.6\text{V} - 2.35\text{V}}{3.5\text{mA}} \quad (1)$$

Figure 2 shows the typical waveform with a VCC recharge after one fault occurs.

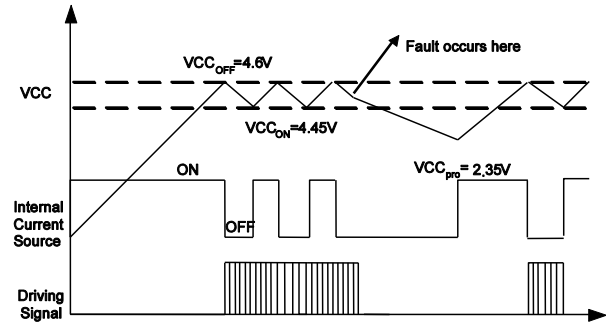

Figure 2: VCC Under-Voltage Lockout

Constant Voltage Operation

The operation of MP9488 resembles a constant on-time (COT) control.

When the feedback voltage drops below the reference voltage (2.55V, which indicates an insufficient output voltage), the integrated MOSFET is turned on, indicating a new switching cycle. The on period is determined by the peak-current limit with about 10μs of maximum on time. After the on period elapses, the integrated MOSFET is turned off. The freewheeling diode (D1) and D2 are turned on due to the inductor current. The voltage of the sampling capacitor (C3) is then charged to equal to the output voltage, and SW is pulled to GND. The voltage across the sampling capacitor (C3) changes along with the output voltage and holds the output voltage when the internal MOSFET turns on. The MP9488 senses this voltage to regulate V_{OUT}. The detailed operation of continuous conduction mode (CCM) is shown in Figure 3.

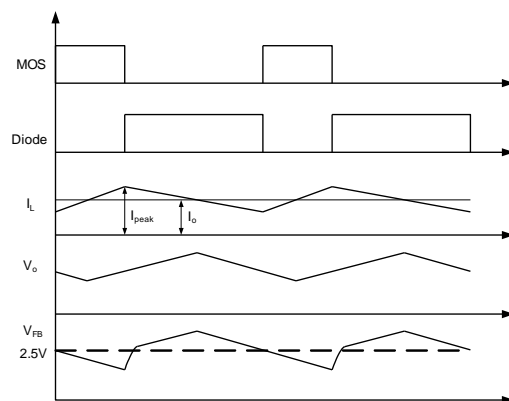

Figure 3: V_{FB} vs. V_{OUT}

By monitoring the sampling capacitor, the output voltage can be regulated. The output voltage can be determined with Equation (2):

$$V_{OUT} = 2.55V \times \frac{R1+R2}{R2} \quad (2)$$

In the actual circuit, the sampled voltage may differ from the real output voltage due to the layout and different characteristics of D1 and D2, especially at light load, where D1 may not conduct at all. As a result, a dummy load is necessary to keep V_{OUT} in good regulation in no-load condition.

Frequency Foldback

At light-load or no-load conditions, the output drops very slowly. This makes the MOSFET off time increase, so the frequency decreases as the load decreases. Therefore, the MP9488 can maintain a high efficiency in light-load condition by reducing the switching frequency automatically.

The switching frequency in CCM condition can be calculated with Equation (3):

$$f_s = \frac{(V_{IN} - V_{OUT})}{2L(I_{PEAK} - I_{OUT})} \cdot \frac{V_{OUT}}{V_{IN}} \quad (3)$$

At the same time, the peak-current limit starts to decrease from 640mA as the off time increases. In standby mode, the frequency and the peak current are both at a minimum, so a smaller dummy load is sufficient. As a result, a peak-current compression function helps save no-load consumption. The peak-current limit can be calculated by Equation (4):

$$I_{PEAK} = 640mA - (3mA/\mu s) \times (T_{off} - 13.1\mu s) \quad (4)$$

Where T_{off} is the off time of the power module.

Minimum Off Time Limitation

A minimum off time limitation is implemented in the MP9488. During normal operation, the minimum off time limit is about 13.1 μ s. During the start-up period, the minimum off time limit is shortened gradually from 52.4 μ s to 13.1 μ s (see Figure 4). Each minimum off time lasts for 128 switching cycles. This soft-start function ensures a safe start-up.

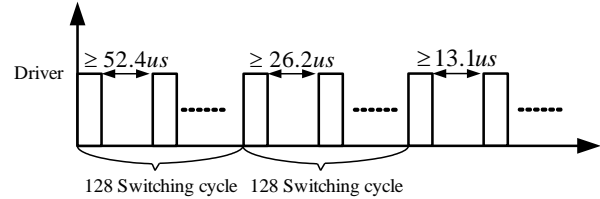

Figure 4: t_{minoff} at Start-Up

EA Compensation

To achieve a better load regulation, the MP9488 employs an error amplifier (EA) compensation function (see Figure 5). After a 6 μ s delay from the MOSFET turning off, the MP9488 samples the feedback voltage. With EA compensation, the reference voltage (2.55V) can be regulated with the load. This can achieve a better regulation of the power module.

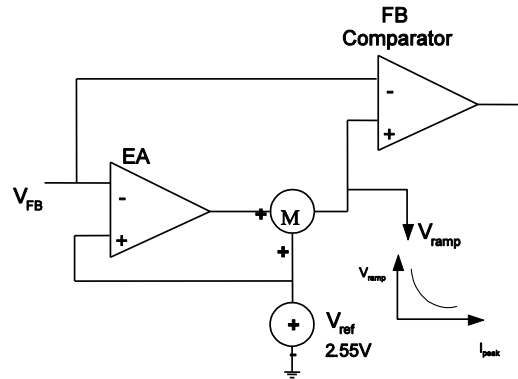

Figure 5: EA and Ramp Compensation

Ramp Compensation

To maintain a precise output voltage, an internal ramp compensation circuit is added. An exponential voltage sinking source is added to pull down the reference voltage of the feedback comparator (see Figure 5). The ramp compensation is related to the load conditions. In full-load condition, the compensation is about 3mV/ μ s. When the load decreases, the compensation increases exponentially.

Overload Protection (OLP)

As the load increases, the peak current and the switching frequency both increase. When the switching frequency and peak current reach the maximum, the output voltage decreases if the load continues to increase, so the FB voltage drops below the OLP point.

By continuously monitoring the FB voltage, when the FB voltage drops below 1.7V (which is considered to be an error flag), the timer begins counting. If the error flag is removed, the timer resets. If the timer ends when it has counted to 150ms ($F_S = 37\text{kHz}$), OLP occurs. This timer duration prevents a trigger of the OLP function when the power supply is at a start-up or load transition phase. The power supply should start up in less than 150ms ($F_S = 37\text{kHz}$). Different switching frequencies (f_s) lead to different OLP delay times, as shown in Equation (5):

$$T_{\text{Delay}} \approx 150\text{ms} \times \frac{37\text{kHz}}{f_s} \quad (5)$$

After OLP is triggered, the MP9488 restarts after VCC discharges to 2.35V.

Short-Circuit Protection (SCP)

The MP9488 monitors the peak current and shuts down when the peak current rises above 900mA, featuring a short-circuit protection (SCP). Once the fault disappears, the power supply resumes operation after VCC discharges to 2.35V.

Open-Loop Detection

If the FB voltage is lower than 60mV in a condition (i.e.: R1 is not soldered well), the IC stops working and a restart cycle begins after VCC discharges to 2.35V. During the start-up, open loop detection is blanked for 128 switching cycles.

Leading Edge Blanking (LEB)

To avoid a premature termination of the switching pulse due to the parasitic capacitance, an internal leading edge blanking (LEB) unit is employed between the current sense resistor inside the IC and the current comparator input. During the blanking time, the current comparator is disabled and cannot turn off the MOSFET (see Figure 6).

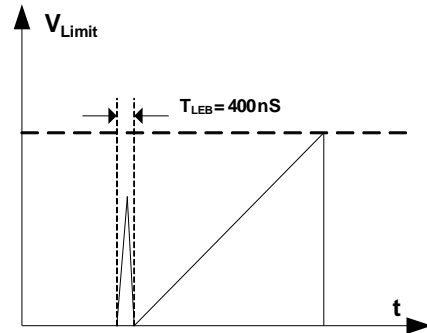

Figure 6: Leading Edge Blanking

Thermal Shutdown

To protect against any lethal thermal damage, the MP9488 shuts down the switching cycle when the inner temperature exceeds 150°C. During thermal shutdown, VCC is discharged to 2.35V and recharged by the internal high-voltage regulator.

APPLICATION INFORMATION

Topology Options

The MP9488 can be used in common topologies, such as buck, buck boost, boost, and flyback (see Table 1).

Table 1: Common Topologies Using the MP9488

Topology	Circuit Schematic	Features
High-Side Buck		<ol style="list-style-type: none"> 1. No isolation 2. Positive output 3. Low cost 4. Direct feedback
High-Side Buck Boost		<ol style="list-style-type: none"> 1. No isolation 2. Negative output 3. Low cost 4. Direct feedback
Boost		<ol style="list-style-type: none"> 1. No isolation 2. Positive output 3. Low cost 4. Direct feedback
Flyback		<ol style="list-style-type: none"> 1. Isolation 2. Positive output 3. Low cost 4. Indirect feedback

BUCK OPERATION

Input Capacitor

The input capacitor is used to supply DC input voltage to the converter. Because the input voltage is usually high, an aluminum electrolytic capacitor is recommended.

By ignoring the current ripple, the RMS current through the input capacitor can be approximated with Equation (6):

$$I_{IN_AC} = I_{OUT} \times \sqrt{\frac{V_{OUT}}{V_{IN}} \times \left(1 - \frac{V_{OUT}}{V_{IN}}\right)} \quad (6)$$

Then the total peak-to-peak ripple on VIN can be estimated with Equation (7):

$$\Delta V_{IN} = \frac{I_{OUT} \times V_{OUT}}{F_{SW} \times C_{IN} \times V_{IN}} \times \left(1 - \frac{V_{OUT}}{V_{IN}}\right) + I_{OUT} \times ESR \quad (7)$$

Inductor

The MP9488 has a minimum off time limit that decides the maximum power it can output. The maximum power increases as the inductor increases. Using a smaller inductor leads to a lower load capability. The maximum power in CCM condition can be obtained with Equation (8):

$$P_{o\max} = V_o \left(I_{peak} - \frac{V_o t_{min\ off}}{2L} \right) \quad (8)$$

To consider the parameter error of the converter (such as peak current limit, minimum off time, etc), calculate the minimum value (P_{min}) of the maximum power. The principle of choosing the inductor is that P_{min} should be higher than the rated power.

For CCM operation, if the input voltage is too high, the selection of L should make the frequency of the converter lower than 40kHz to reduce turn-on switching loss caused by the reverse-recovery of the freewheeling diode.

Freewheeling Diode

The diode should have a maximum reverse voltage rating greater than the maximum input voltage. The current rating of the diode is determined by the output current.

The reverse recovery of the freewheeling diode can affect the efficiency and the circuit operation. For CCM operation, an ultra-fast diode with $T_{rr} < 35ns$ (i.e.: STTH2R06, STTH1R06, or UGC10JH) can be used. For DCM operation, use a diode with $T_{rr} < 75ns$.

Sampling Diode

The diode is used to charge the sample-and-hold capacitor when the MOSFET is turned off so the MP9488 can obtain feedback information about the output.

To achieve good regulation, this diode should be the same as the freewheeling diode, theoretically. Otherwise, the sampling diode can conduct while the freewheeling diode is blocked. As a result, the sampled voltage is much different from the real output voltage. Considering cost, it is not practical to use a diode identical to the freewheeling diode. The minimum requirement is to use a diode with a minimum T_{rr} . If the T_{rr} is long, the sampled voltage may be lower than the real output voltage, especially at a low input condition.

Output Capacitor

An output capacitor is required to maintain the DC output voltage. The output voltage ripple in CCM condition can be estimated with Equation (9):

$$V_{ripple} = \frac{\Delta i}{8f_s C_o} + \Delta i \cdot R_{ESR} \quad (9)$$

Ceramic, tantalum, or low ESR electrolytic capacitors are used to reduce the output voltage ripple.

Feedback Resistors

The resistor divider determines the output voltage. Choose appropriate values for R1 and R2 to maintain V_{FB} at 2.55V. Avoid a large R2 value (typically 4kΩ to 10kΩ).

Place a large capacitor (valued at hundreds of pF) between FB and SW as close to the IC as possible to filter noise.

Feedback Sampling Capacitor

The feedback capacitor (C3) provides a sample-and-hold function. Small capacitors result in poor regulation at light loads, and large capacitors may result in instability. Roughly estimate an optimal capacitor value using Equation (10):

$$\frac{1}{2} \frac{V_o}{R_1 + R_2} \cdot \frac{C_o}{I_o} \leq C_3 \leq \frac{V_o}{R_1 + R_2} \cdot \frac{C_o}{I_o} \quad (10)$$

Choose the nearest appropriate value.

Dummy Load

A dummy load is required to maintain load regulation. This ensures sufficient inductor energy to charge the sample-and-hold capacitor to detect the output voltage. Normally, a 3~5mA dummy load is needed and can be adjusted based on the regulated voltage. Increasing the dummy load reduces the efficiency and no-load consumption. Use a Zener diode if no-load regulation is not a concern.

Auxiliary VCC Supply

If the output voltage is higher than the VCC voltage, an auxiliary VCC supply can be implemented by connecting a diode (D3) and a resistor (R3) between C3 and C4 to reduce overall power consumption (see Figure 7).

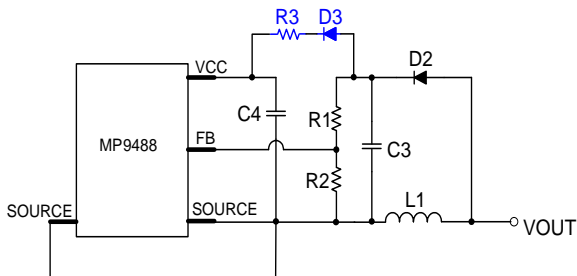

Figure 7: Auxiliary VCC Supply Circuit

The voltage of VCC is clamped to 4.8V by an internal circuit, and the internal regulator is turned off. For values above $V_o = 7V$, determine R3 with Equation (11):

$$R \approx \frac{V_o - 4.8V}{165\mu A} \quad (11)$$

Note that the charging current can be $165\mu A \sim 1mA$ but cannot exceed 2mA.

PCB Layout Guidelines

Efficient PCB layout is critical for stable operation, good EMI, and good thermal performance. For best results, refer to Figure 8 and follow the guidelines below.

- 1) Minimize the loop area formed by the input capacitor, IC, freewheeling diode, inductor and output capacitor.
- 2) Route the FB trace far away from the VIN/VOUT traces.
- 3) Place the FB resistors (R1, R2) as close to FB as possible.
- 4) Place R2 close to SW.
- 5) Connect VIN and NC to a larger copper area to improve thermal performance.

Figure 8 shows an example of PCB layout, for which the circuit schematic can be found on page 1

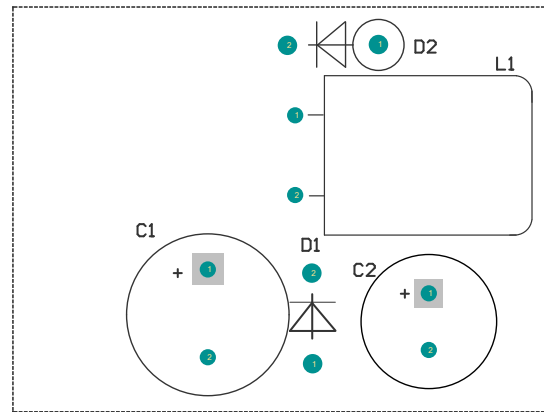

Top Layer

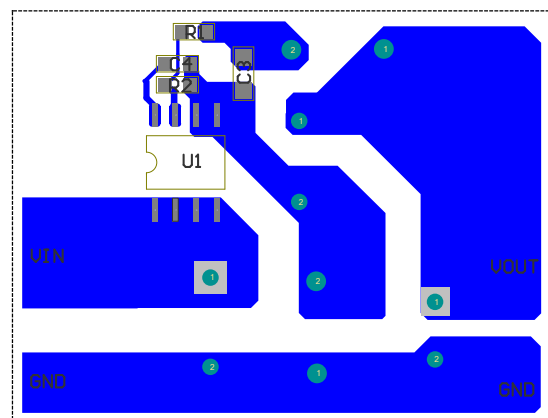

Bottom Layer

Figure 8: Recommended Layout

Design Example

Table 3 is a design example following the application guidelines for the specifications below.

Table 3: Design Example

V_{IN}	48V - 400V
V_{OUT}	15V
I_{OUT}	300mA

The detailed application schematic is shown in Figure 9. The typical performance and circuit waveforms are shown in the Typical Performance Characteristics section. For more device applications, please refer to the related evaluation board datasheet.

TYPICAL APPLICATION CIRCUIT

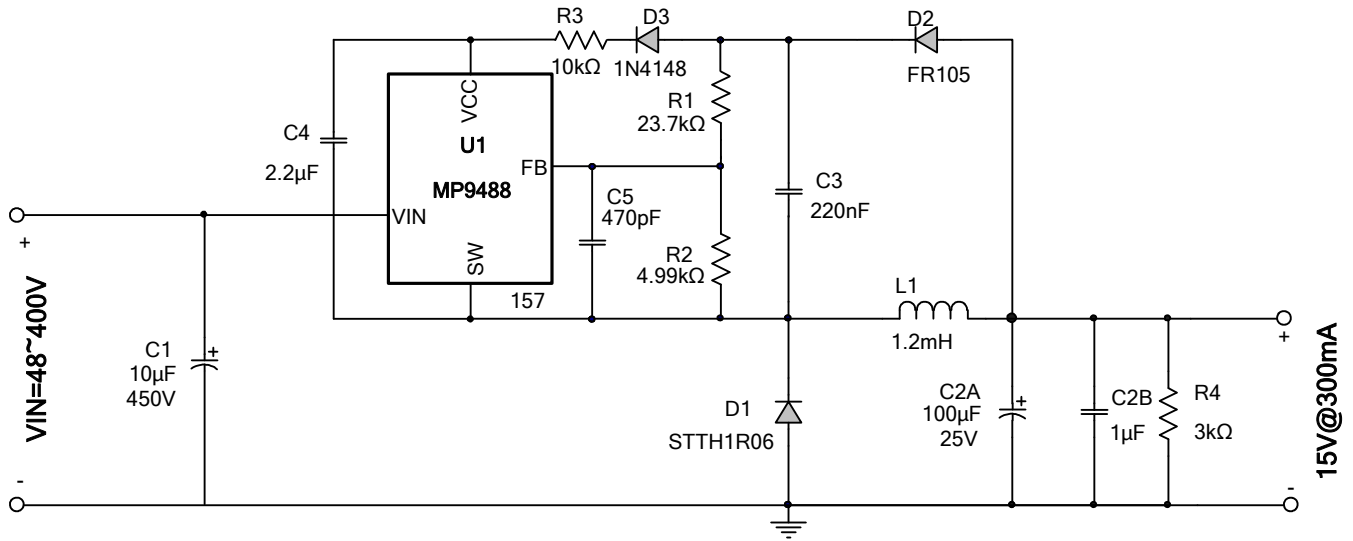
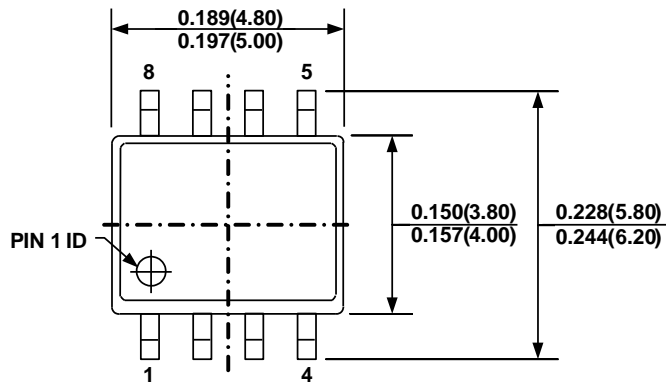

Figure 9: Typical Application at 15V, 300mA

PACKAGE INFORMATION

SOIC-8



TOP VIEW

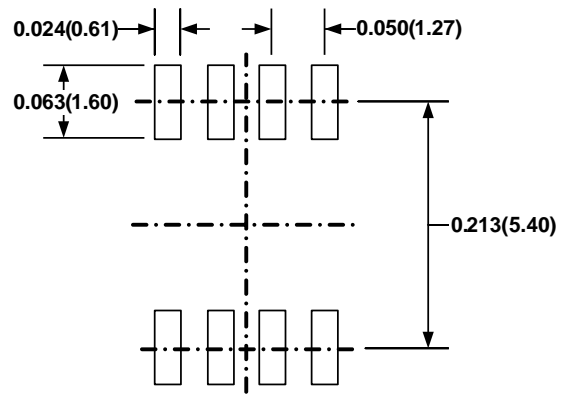

RECOMMENDED LAND PATTERN

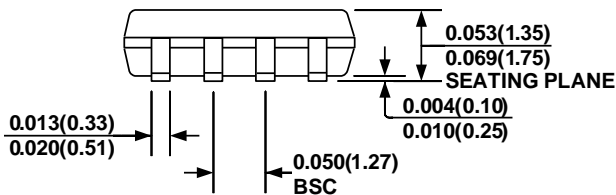

FRONT VIEW

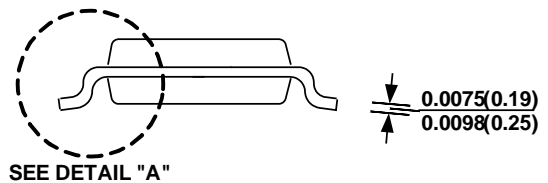

SIDE VIEW

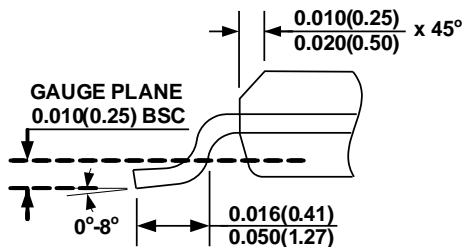

DETAIL "A"

NOTE:

- 1) CONTROL DIMENSION IS IN INCHES DIMENSION IN BRACKET IS IN MILLIMETERS
- 2) PACKAGE LENGTH DOES NOT INCLUDE MOLD FLASH, PROTRUSIONS OR GATE BURRS
- 3) PACKAGE WIDTH DOES NOT INCLUDE INTERLEAD FLASH OR PROTRUSIONS.
- 4) LEAD COPLANARITY(BOTTOM OF LEADS AFTER FORMING) SHALL BE 0.004" INCHES MAX.
- 5) DRAWING CONFORMS TO JEDEC MS012, VARIATION AA
- 6) DRAWING IS NOT TO SCALE

NOTICE: The information in this document is subject to change without notice. Please contact MPS for current specifications. Users should warrant and guarantee that third party Intellectual Property rights are not infringed upon when integrating MPS products into any application. MPS will not assume any legal responsibility for any said applications.