

Data Sheet | Item Number: 2010-1301

3-conductor through terminal block; 10 mm²; suitable for Ex e II applications; side and center marking; for DIN-rail 35 x 15 and 35 x 7.5; Push-in CAGE CLAMP®; 10,00 mm²; gray

<https://www.wago.com/2010-1301>

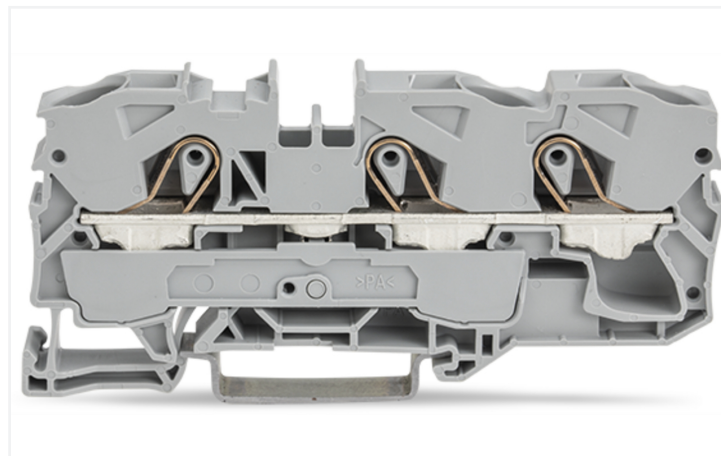
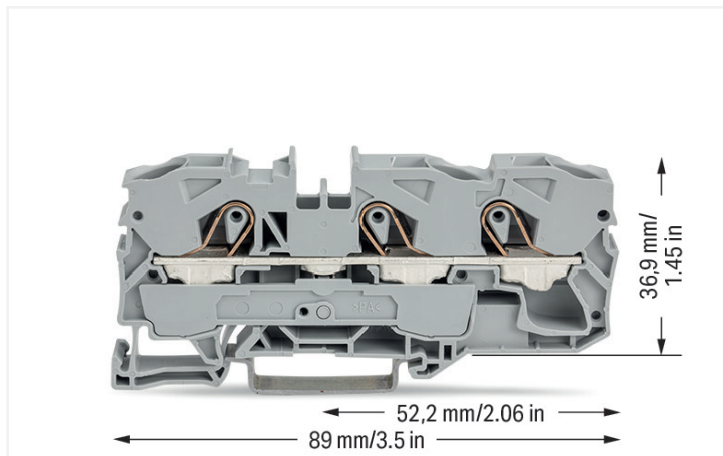

Color: ■ gray

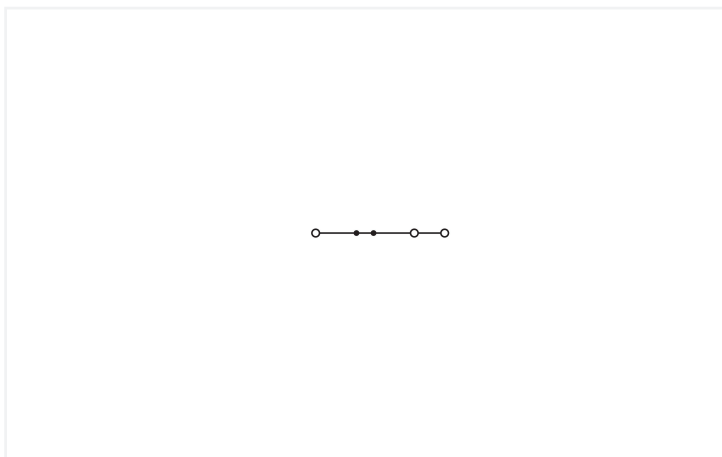

Similar to illustration

Through terminal block, 2010 Series, gray

Connect conductors quickly and securely with this through terminal block (item number 2010-1301). Conductors should only be connected to this through terminal block if their strip length is between 17 and 19 mm. Whether for use in industry or building installations, our rail-mount through terminal blocks allow you to quickly and securely connect electrical conductors. They're perfect for either classic through-wiring or distributing potential, depending on the variant. Featuring conductor terminals along with Push-in CAGE CLAMP®, this connector outperforms the competition. Push-in CAGE CLAMP® connection technology is ideal for connecting all conductor types. Both solid and fine-stranded conductors with ferrules can be inserted without the need for tools—all thanks to its pluggable design. The item's dimensions are (10 x 89 x 43.5) mm (width x height x depth). Depending on the type of conductor, this through terminal block is suitable for conductor cross sections ranging from 0.5 mm² to 16 mm².

An operating tool is used to operate this through rail-mount terminal block. Our TOPJOB® S rail-mount terminal blocks are perfect for many different industrial applications and modern building installations thanks to the secure electrical connections they provide. You can work anywhere in the world and on any application with just a single rail-mount terminal block system. This product is designed for specific Ex applications (please refer to the product datasheet).

Electrical data

Ratings per	IEC/EN 60947-7-1		
Overvoltage category	III	III	II
Pollution degree	3	2	2
Nominal voltage	800 V	-	-
Rated impulse withstand voltage	8 kV	-	-
Rated current	57 A	-	-
Current at conductor cross-section (max.) mm ²	76 A	-	-

Approvals per	UL 1059		
Use group	B	C	D
Rated voltage	600 V	600 V	-
Rated current	65 A	65 A	-

Approvals per	CSA 22.2 No 158		
Use group	B	C	D
Rated voltage	600 V	600 V	-
Rated current	65 A	65 A	-

Ex information	
Reference to hazardous areas	See application instructions in section "Knowledge and Downloads – Documentation – Additional Information: Technical Section; Technical Explanations"
Ratings per	ATEX: PTB 05 ATEX 1070 U / IECEx: PTB 06.0003U (Ex eb IIC Gb)
Rated voltage EN (Ex e II)	550 V
Rated current (Ex e II)	50 A

Power Loss

Power loss, per pole (potential)	1.8194 W
Rated current I _N for power loss specification	57 A
Resistance value for specified, current-dependent power loss	0.00056 Ω

General information

Wiring direction	Front-entry wiring
------------------	--------------------

Connection Data

Clamping units	3
Total number of potentials	1
Number of levels	1
Number of jumper slots	2

Connection 1	
Connection technology	Push-in CAGE CLAMP®
Actuation type	Operating tool
Connectable conductor materials	Copper
Nominal cross-section	10 mm ²
Solid conductor	0.5 ... 16 mm ² / 20 ... 6 AWG
Solid conductor; push-in termination	4 ... 16 mm ² / 14 ... 6 AWG
Fine-stranded conductor	0.5 ... 16 mm ² / 20 ... 6 AWG
Fine-stranded conductor; with insulated ferrule	0.5 ... 10 mm ² / 20 ... 8 AWG
Fine-stranded conductor; with ferrule; push-in termination	4 ... 10 mm ² / 12 ... 8 AWG
Note (conductor cross-section)	Depending on the conductor characteristic, a conductor with a smaller cross-section can also be inserted via push-in termination. AWG specifications were converted according to IEC.
Strip length	17 ... 19 mm / 0.67 ... 0.75 inches
Wiring direction	Front-entry wiring

Physical data

Width	10 mm / 0.394 inches
Height	89 mm / 3.504 inches
Depth from upper-edge of DIN-rail	36.9 mm / 1.453 inches
Depth	43.5 mm / 1.713 inches

Mechanical data

Mounting type	DIN-35 rail
Marking level	Center/side marking

Material data

Note (material data)	Information on material specifications can be found here
Color	gray
Material group	I
Insulation material (main housing)	Polyamide (PA66)
Flammability class per UL94	V0
Fire load	0.367 MJ
Weight	24.7 g

Environmental requirements

Processing temperature	-35 ... +85 °C
Continuous operating temperature	-60 ... +105 °C

Environmental Testing

Test specification: Railway applications – Rolling stock – Electronic equipment	DIN EN 50155 (VDE 0115-200):2022-06
Test procedure: Railway applications – Rolling stock equipment – Vibration and shock tests	DIN EN 61373 (VDE 0115-0106):2011-04
Spectrum/Mounting location	Service life test, Category 1, Class A/B
Functional test with noise-like oscillations	Test passed according to Section 8 of the standard
Frequency	$f_1 = 5 \text{ Hz}$ to $f_2 = 150 \text{ Hz}$
Acceleration	0.101g (highest test level used for all axes)
Test duration per axis	10 min.
Test directions	X, Y and Z axes
Monitoring of contact faults and interruptions	Passed
Voltage drop measurement before and after each axis	Passed
Simulated service life test through increased levels of noise-like oscillations	Test passed according to Section 9 of the standard
Frequency	$f_1 = 5 \text{ Hz}$ to $f_2 = 150 \text{ Hz}$
Acceleration	0.572g (highest test level used for all axes)
Test duration per axis	5 h
Test directions	X, Y and Z axes
Extended testing: Monitoring of contact faults and interruptions	Passed
Extended testing: Voltage drop measurement before and after each axis	Passed
Shock test	Test passed according to Section 10 of the standard
Shock pulse form	Half sine
Acceleration	5g (highest test level used for all axes)
Shock duration	30 ms
Number of shocks (per axis)	3 pos. und 3 neg.
Test directions	X, Y and Z axes

Environmental Testing

Extended testing: Monitoring of contact faults and interruptions	Passed
Extended testing: Voltage drop measurement before and after each axis	Passed
Vibration and shock stress for rolling stock equipment	Passed

Commercial data

Product Group	22 (TOPJOB S)
PU (SPU)	25 pcs
Packaging type	Box
Country of origin	DE
GTIN	4017332011341
Customs tariff number	85369010000

Product Classification

UNSPSC	39121410
eCl@ss 10.0	27-14-11-20
eCl@ss 9.0	27-14-11-20
ETIM 9.0	EC000897
ETIM 10.0	EC000897
ECCN	NO US CLASSIFICATION

Environmental Product Compliance

RoHS Compliance Status	Compliant, No Exemption
------------------------	-------------------------

Approvals / Certificates

General approvals



Approval	Standard	Certificate Name
CCA DEKRA Certification B.V.	EN 60947	NTR NL 7876
CSA DEKRA Certification B.V.	C22.2 No. 158	70111238
DEKRA DEKRA Certification B.V.	EN 60947	71-145803
KEMA/KEUR DEKRA Certification B.V.	EN 60947	71-119201
UL UL International Germany GmbH	UL 1059	E45172

Declarations of conformity and manufacturer's declarations



Approval	Standard	Certificate Name
ATEX-Attestation of Conformity WAGO GmbH & Co. KG	-	-
EU-Declaration of Conformity WAGO GmbH & Co. KG	-	-
Railway WAGO GmbH & Co. KG	-	Railway Ready
UK-Declaration of Conformity WAGO GmbH & Co. KG	-	-

Approvals for marine applications



Approval	Standard	Certificate Name
ABS American Bureau of Shipping	-	24-0152298-PDA
DNV GL Det Norske Veritas, Germanischer Lloyd	-	TAE00001V2
PRS Polski Rejestr Statków	-	TE/1094/880590/23

Approvals for hazardous areas



Approval	Standard	Certificate Name
AEx UL International Germany GmbH c/o Physikalisch Technische Bundesanstalt	UL 60079	E185892 (Ex e II)
ATEX Physikalisch Technische Bundesanstalt (PTB)	EN 60079	PTB 05 ATEX 1070 U (II 2 G Ex eb II C bzw. I M 2 Ex eb I Mb)
IECEX Physikalisch Technische Bundesanstalt (PTB)	IEC 60079	IECEX PTB 06.0003 U (Ex eb IIC Gb and Ex ebI Mb)
INMETRO TÜV Rheinland do Brasil Ltda.	IEC 60079	TÜV 12.1311 U

Downloads

Environmental Product Compliance

Compliance Search

Environmental Product Compliance 2010-1301	↓
--	---

Documentation

Bid Text

Item Number	Date	File Name	Size	Action
2010-1301	17.04.2019	xml	4.08 KB	↓
2010-1301	17.04.2019	docx	15.04 KB	↓

CAD/CAE-Data

CAD data

2D/3D Models 2010-1301	↓
------------------------	---

CAE data

EPLAN Data Portal 2010-1301	↓
WSCAD Universe 2010-1301	↓
ZUKEN Portal 2010-1301	↓

1 Compatible Products

1.1 Required Accessories

1.1.1 End plate

1.1.1.1 End plate



Item No.: 2010-1391

End and intermediate plate; 1 mm thick; gray



Item No.: 2010-1392

End and intermediate plate; 1 mm thick; orange



Item No.: 209-191

Separator for Ex e/Ex i applications; 3 mm thick; 120 mm wide; orange

1.2 Optional Accessories

1.2.1 Cover

1.2.1.1 Cover



Item No.: 2010-100

Finger guard; touchproof cover protects unused conductor entries; yellow

1.2.2 DIN-rail

1.2.2.1 Mounting accessories



Item No.: 210-196

Aluminum carrier rail; 35 x 8.2 mm; 1.6 mm thick; 2 m long; unslotted; similar to EN 60715; silver-colored



Item No.: 210-198

Copper carrier rail; 35 x 15 mm; 2.3 mm thick; 2 m long; unslotted; according to EN 60715; copper-colored



Item No.: 210-197

Steel carrier rail; 35 x 15 mm; 1.5 mm thick; 2 m long; slotted; similar to EN 60715; silver-colored



Item No.: 210-114

Steel carrier rail; 35 x 15 mm; 1.5 mm thick; 2 m long; unslotted; similar to EN 60715; silver-colored



Item No.: 210-118

Steel carrier rail; 35 x 15 mm; 2.3 mm thick; 2 m long; unslotted; according to EN 60715; silver-colored



Item No.: 210-113

Steel carrier rail; 35 x 7.5 mm; 1 mm thick; 2 m long; unslotted; according to EN 60715; silver-colored

1.2.3 Ferrule

1.2.3.1 Ferrule



Item No.: 216-284

Ferrule; Sleeve for 1.5 mm² / AWG 16; insulated; electro-tin plated; electrolytic copper; gastight crimped; acc. to DIN 46228, Part 4/09.90; black



Item No.: 216-289

Ferrule; Sleeve for 10 mm² / AWG 8; insulated; electro-tin plated; electrolytic copper; gastight crimped; acc. to DIN 46228, Part 4/09.90; red



Item No.: 216-286

Ferrule; Sleeve for 2.5 mm² / AWG 14; insulated; electro-tin plated; electrolytic copper; gastight crimped; acc. to DIN 46228, Part 4/09.90; blue



Item No.: 216-287

Ferrule; Sleeve for 4 mm² / AWG 12; insulated; electro-tin plated; electrolytic copper; gastight crimped; acc. to DIN 46228, Part 4/09.90; gray



Item No.: 216-288

Ferrule; Sleeve for 6 mm² / AWG 10; insulated; electro-tin plated; electrolytic copper; gastight crimped; acc. to DIN 46228, Part 4/09.90; yellow

1.2.4 Installation

1.2.4.1 Cover



Item No.: 709-156

Cover, Type 3; suitable for cover carrier, type 3; 1 m long; transparent

1.2.4.2 Cover carrier



Item No.: 709-169

Cover carrier; Type 3; incl. fixing/retaining screws and knurled nut; suitable for 279 to 282 and 880 Series rail-mounted terminal blocks; suitable for 264 Series miniature rail-mounted terminal blocks; suitable for 270 Series sensor and actuator terminal blocks; gray

1.2.5 Jumper

1.2.5.1 Jumper



Item No.: 2010-402

Jumper; 2-way; insulated; light gray



Item No.: 2010-403

Jumper; 3-way; insulated; light gray



Item No.: 2010-404

Jumper; 4-way; insulated; light gray



Item No.: 2010-405

Jumper; 5-way; insulated; light gray



Item No.: 2010-433

Jumper; from 1 to 3; insulated; light gray



Item No.: 2010-434

Jumper; from 1 to 4; insulated; light gray



Item No.: 2010-435

Jumper; from 1 to 5; insulated; light gray



Item No.: 2010-405/011-000

Star point jumper; 3-way; insulated; light gray



Item No.: 2016-499

Step-down jumper; from 2016/2010 to 2010/2006/2004/2002 series; from 2216/2210 to 2210/2206/2204/2202 series; insulated; light gray



Item No.: 285-430

Step-down jumper; from 285 (35mm²) to 2016/2010 series; insulated; gray

1.2.6 Marking

1.2.6.1 Group marker carrier



Item No.: 2009-191

Group marker carrier; gray



Item No.: 2009-192

Group marker carrier; gray



Item No.: 2009-193

Group marker carrier; gray

1.2.6.2 Marker

Item No.: 2009-145/000-006

Mini-WSB Inline; for Smart Printer; 1700 pieces on roll; stretchable 5 - 5.2 mm; plain; snap-on type; blue



Item No.: 2009-145/000-007

Mini-WSB Inline; for Smart Printer; 1700 pieces on roll; stretchable 5 - 5.2 mm; plain; snap-on type; gray



Item No.: 2009-145/000-023

Mini-WSB Inline; for Smart Printer; 1700 pieces on roll; stretchable 5 - 5.2 mm; plain; snap-on type; green



Item No.: 2009-145/000-012

Mini-WSB Inline; for Smart Printer; 1700 pieces on roll; stretchable 5 - 5.2 mm; plain; snap-on type; orange



Item No.: 2009-145/000-005

Mini-WSB Inline; for Smart Printer; 1700 pieces on roll; stretchable 5 - 5.2 mm; plain; snap-on type; red

Item No.: 2009-145/000-024

Mini-WSB Inline; for Smart Printer; 1700 pieces on roll; stretchable 5 - 5.2 mm; plain; snap-on type; violet

Item No.: 2009-145

Mini-WSB Inline; for Smart Printer; 1700 pieces on roll; stretchable 5 - 5.2 mm; plain; snap-on type; white

Item No.: 2009-145/000-002

Mini-WSB Inline; for Smart Printer; 1700 pieces on roll; stretchable 5 - 5.2 mm; plain; snap-on type; yellow



Item No.: 248-501/000-006

Mini-WSB marking card; as card; not stretchable; plain; snap-on type; blue



Item No.: 248-501/000-007

Mini-WSB marking card; as card; not stretchable; plain; snap-on type; gray



Item No.: 248-501/000-023

Mini-WSB marking card; as card; not stretchable; plain; snap-on type; green



Item No.: 248-501/000-017

Mini-WSB marking card; as card; not stretchable; plain; snap-on type; light green



Item No.: 248-501/000-012

Mini-WSB marking card; as card; not stretchable; plain; snap-on type; orange



Item No.: 248-501/000-005

Mini-WSB marking card; as card; not stretchable; plain; snap-on type; red



Item No.: 248-501/000-024

Mini-WSB marking card; as card; not stretchable; plain; snap-on type; violet



Item No.: 248-501

Mini-WSB marking card; as card; not stretchable; plain; snap-on type; white



Item No.: 248-501/000-002

Mini-WSB marking card; as card; not stretchable; plain; snap-on type; yellow



Item No.: 793-5501/000-006

WMB marking card; as card; for terminal block width 5 - 17.5 mm; stretchable 5 - 5.2 mm; plain; snap-on type; blue



Item No.: 793-5501/000-007

WMB marking card; as card; for terminal block width 5 - 17.5 mm; stretchable 5 - 5.2 mm; plain; snap-on type; gray



Item No.: 793-5501/000-023

WMB marking card; as card; for terminal block width 5 - 17.5 mm; stretchable 5 - 5.2 mm; plain; snap-on type; green



Item No.: 793-5501/000-017

WMB marking card; as card; for terminal block width 5 - 17.5 mm; stretchable 5 - 5.2 mm; plain; snap-on type; light green



Item No.: 793-5501/000-012

WMB marking card; as card; for terminal block width 5 - 17.5 mm; stretchable 5 - 5.2 mm; plain; snap-on type; orange



Item No.: 793-5501/000-005

WMB marking card; as card; for terminal block width 5 - 17.5 mm; stretchable 5 - 5.2 mm; plain; snap-on type; red



Item No.: 793-5501/000-024

WMB marking card; as card; for terminal block width 5 - 17.5 mm; stretchable 5 - 5.2 mm; plain; snap-on type; violet



Item No.: 793-5501

WMB marking card; as card; for terminal block width 5 - 17.5 mm; stretchable 5 - 5.2 mm; plain; snap-on type; white



Item No.: 793-5501/000-002

WMB marking card; as card; for terminal block width 5 - 17.5 mm; stretchable 5 - 5.2 mm; plain; snap-on type; yellow



Item No.: 793-501/000-006

WMB marking card; as card; not stretchable; plain; snap-on type; blue



Item No.: 793-501/000-007

WMB marking card; as card; not stretchable; plain; snap-on type; gray



Item No.: 793-501/000-023

WMB marking card; as card; not stretchable; plain; snap-on type; green



Item No.: 793-501/000-017

WMB marking card; as card; not stretchable; plain; snap-on type; light green



Item No.: 793-501/000-012

WMB marking card; as card; not stretchable; plain; snap-on type; orange



Item No.: 793-501/000-005

WMB marking card; as card; not stretchable; plain; snap-on type; red



Item No.: 793-501/000-024

WMB marking card; as card; not stretchable; plain; snap-on type; violet



Item No.: 793-501

WMB marking card; as card; not stretchable; plain; snap-on type; white



Item No.: 793-501/000-002

WMB marking card; as card; not stretchable; plain; snap-on type; yellow



Item No.: 2009-115/000-006

WMB-Inline; for Smart Printer; 1500 pieces on roll; stretchable 5 - 5.2 mm; plain; snap-on type; blue



Item No.: 2009-115/000-007

WMB-Inline; for Smart Printer; 1500 pieces on roll; stretchable 5 - 5.2 mm; plain; snap-on type; gray



Item No.: 2009-115/000-023

WMB-Inline; for Smart Printer; 1500 pieces on roll; stretchable 5 - 5.2 mm; plain; snap-on type; green



Item No.: 2009-115/000-017

WMB-Inline; for Smart Printer; 1500 pieces on roll; stretchable 5 - 5.2 mm; plain; snap-on type; light green



Item No.: 2009-115/000-012

WMB-Inline; for Smart Printer; 1500 pieces on roll; stretchable 5 - 5.2 mm; plain; snap-on type; orange



Item No.: 2009-115/000-024

WMB-Inline; for Smart Printer; 1500 pieces on roll; stretchable 5 - 5.2 mm; plain; snap-on type; violet



Item No.: 2009-115

WMB-Inline; for Smart Printer; 1500 pieces on roll; stretchable 5 - 5.2 mm; plain; snap-on type; white



Item No.: 2009-115/000-002

WMB-Inline; for Smart Printer; 1500 pieces on roll; stretchable 5 - 5.2 mm; plain; snap-on type; yellow



1.2.6.3 Marker carrier



Item No.: 2009-198

Adaptor; gray

1.2.6.4 Marking strip



Item No.: 2009-110

Marking strips; for Smart Printer; on reel; not stretchable; plain; snap-on type; white

1.2.7 Protective warning marker

1.2.7.1 Cover



Item No.: 2010-115

Protective warning marker; for 5 terminal blocks; with high-voltage symbol, black; yellow

1.2.8 Screwless end stop

1.2.8.1 Mounting accessories



Item No.: 249-117

Screwless end stop; 10 mm wide; for DIN-rail 35 x 15 and 35 x 7.5; gray



Item No.: 249-116

Screwless end stop; 6 mm wide; for DIN-rail 35 x 15 and 35 x 7.5; gray

1.2.9 Test and measurement

1.2.9.1 Testing accessories



Item No.: 2010-511

Modular TOPJOB®S connector; modular; for jumper contact slot; 1-pole; gray



Item No.: 2010-549

Spacer module; modular; e.g., for bridging commoned terminal blocks; gray



Item No.: 2009-174

Test plug adapter; for 4 mm Ø test plugs; for testing TOPJOB®S rail-mounted terminal blocks; gray



Item No.: 2009-182

Testing tap; for max. 2.5 mm²; tool-free connection for individual test wires 0.08 - 2.5 mm; gray

1.2.10 Tool

1.2.10.1 Operating tool



Item No.: 210-721

Operating tool; Blade: 5.5 x 0.8 mm; with a partially insulated shaft; multicoloured

Installation Notes

Conductor termination

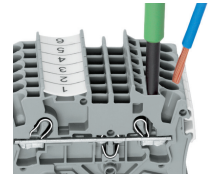
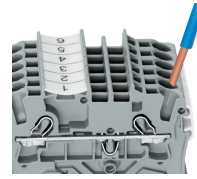
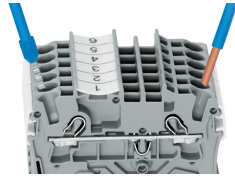
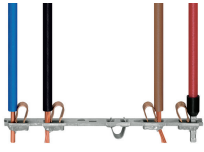

All conductor types at a glance

Push-in termination of solid and ferruled conductors

Inserting a conductor via push-in termination:
Solid conductors with cross-sections from either one size above, or up to two sizes below, the rated cross-section can be simply pushed in – no tools needed.

Inserting a conductor via operating tool:
Connecting fine-stranded conductors without ferrules, or small cross-sectional conductors that cannot be pushed in, is performed similarly to the original CAGE CLAMP® – just use an operating tool.

Advantage:
To open the clamp, the operating tool is inserted vertically. The conductor entry is less than 15 degrees for easier wiring.

Commoning

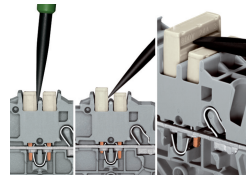
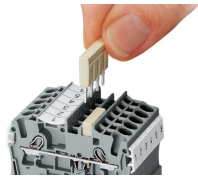

Insert push-in type jumper bar and push down until it hits backstop.

Removing a push-in type jumper bar:
Insert the operating tool between the jumper and partition wall of the dual jumper slots, then lift up the jumper.
Place the operating tool in the center of jumpers for up to five contacts (see above), or alternately on both sides for jumpers with more than five contacts.

Commoning

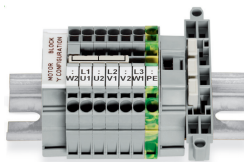

This star point jumper has been specially developed to create a "star point" and is used on motor terminal boards equipped with Rail-Mount Terminal Blocks TOPJOB® S.

Commoning

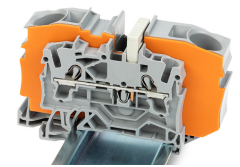
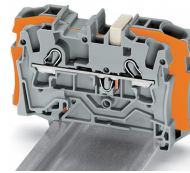
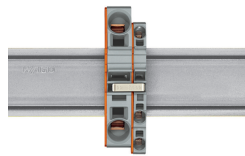
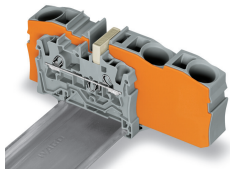

Step-down jumpers common terminal blocks of different sizes, without losing a conductor clamping point. This can be beneficial on long conductor runs where voltage drop can be a problem. A large conductor can be easily connected to smaller conductors at the distribution point. Commoning may be made in either direction using the special thin end plate to cover the open side. Additional through terminal blocks having a smaller cross-section may be commoned using push-in type jumper bars.

Using step-down jumpers, an end plate must be inserted between the terminal blocks to be commoned.

Step-down jumper (Item No. 2006-499) commons 6/4 mm² (10/12 AWG) terminal blocks (2006/2004 Series) with 4/2.5/1.5 mm² (AWG 12/14/16) terminal blocks (2004/2002/2001 Series).

Step-down jumper (Item No. 2016-499) commons 16/10 mm² (16/8 AWG) terminal blocks (2016/2010 Series) with 10/6/4/2.5 mm² (8/10/12/14 AWG) terminal blocks (2010/2006/2004/2002 Series).

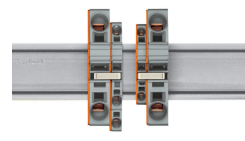
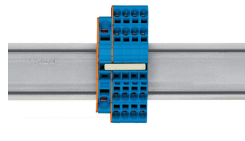
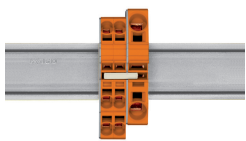

Stepping down via push-in type jumper bar:
Commoning via open terminal side with end plate allows jumpering over two cross-section sizes for 16 mm² (6 AWG) and 10 mm² (8 AWG) and one cross-section size for 6/4/2.5 mm² (10/12/14 AWG). An example: from 16 mm² (6 AWG) to 6 mm² (10 AWG) (see illustration above) or from 10 mm² (8 AWG) to 4 mm² (12 AWG).

Stepping down via push-in type jumper bar:
Commoning via closed terminal side with end plate allows jumpering over two cross-section sizes, e.g., from 16 mm² (6 AWG) to 6 mm² (10 AWG) or from 6 mm² (10 AWG) to 2.5 mm² (14 AWG) (see illustration above).

Note:
The total current of the outgoing circuits must not exceed the nominal current of the step-down jumper/push-in type jumper bar.

Testing

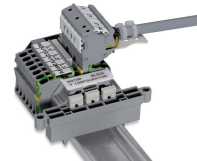
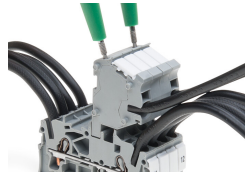
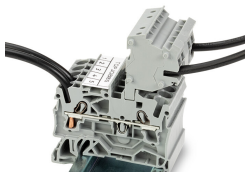

The modular TOPJOB® S connectors also connect conductors of the same size as the terminal blocks being used.

TOPJOB® S Connectors with a 2 mm Ø test socket for testing voltage via 2-pole voltage tester

Rail-mount terminal block assembly for electric motor wiring

Test plug adapter (Item No. 2009-174, CAT I) for 4 mm Ø plugs – compatible with 2000 to 2016 Series



Testing tap (Item No. 2009-182) for tool-free connection of test cables up to 2.5 mm² (12 AWG) – compatible with 2000 to 2016 Series

Marking

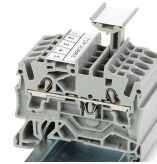
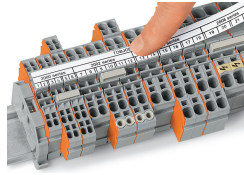
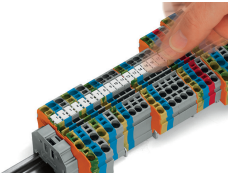

Snapping WMB Inline markers into marker slots.

TOPJOB® S 2009-193 Group Marker Carrier (equipped with a marking strip) for all 2001 to 2016 Series TOPJOB® S Rail-Mount Terminal Blocks
Do not use on an end plate!

Ex application

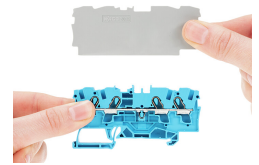
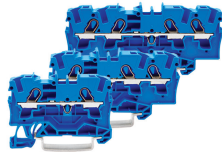
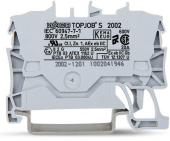

Through terminal blocks with a blue insulated housing are suitable for Ex i applications.

All through and ground conductor terminal blocks are suitable for Ex e II applications.

Separator plate for Ex e/Ex i applications
An end plate must be applied to the terminal block located directly behind an Ex e/Ex i separator plate.

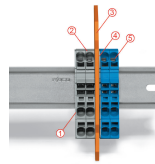

Ex e II/Ex i terminal strip

Note:
The movable feet of terminal blocks and separator plates must face the same direction.

A separator plate is located between the Ex e II and Ex i terminal strip.
End plate
Ex e II terminal blocks
Separator plate for Ex e/Ex i applications
End plate
Ex i terminal blocks
According to EN 50020, a minimum distance of 50 mm must be kept between live parts of Ex e and Ex i circuits. The use of Ex e/Ex i separators is a space-saving solution when Ex e and Ex i terminal blocks are mounted on a common DIN-rail.