

Features

Regulated Converters

- Compact 10.35 x 7.5mm SMD package
- Low profile (2.5mm)
- 3kVDC/1min isolation
- Low EMI emissions
- Ultra-wide temperature range -40°C to +125°C
- Fully automated, high-reliability design
- Semi-regulated 5V output



RxxCTExxS

1 Watt
16-Pin SOIC
Single Output

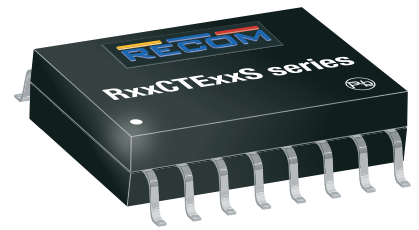

IEC/EN62368-1 3rd Edition certified
 CB Report

Description

The R05CTE05S is a low cost, low profile, 1W SMD isolated DC/DC single output converter with 4.5-5.5V input range and a semi-regulated 5V output. There is no minimum load requirement which is ideal for applications which switch into very light load operation modes. Standard isolation is 3kVDC/1min, and the operating temperature is from -40°C up to +125°C with derating. The fully-automated design which is equipped with short-circuit, over-current, and over-temperature protection ensures the highest reliability in applications such as communication, current sensing, and COM port isolation.

Selection Guide

| Part Number | Input Voltage Range [VDC] | Output Voltage [VDC] | Output Power [W] | Efficiency typ. ⁽¹⁾ [%] |
|-------------|---------------------------|----------------------|------------------|------------------------------------|
| R05CTE05S | 4.5-5.5 | 5 | 1 | 54 |

Notes:

Note1: nom. V_{IN} = 5VDC, V_{OUT} = 5VDC, full load

Model Numbering

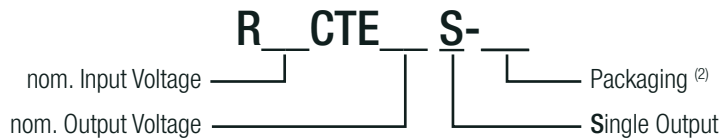

Notes:

Note2: add suffix “-R” for standard tape and reel packaging
 add suffix “-CT” for bag packaging for more details refer to “PACKAGING INFORMATION”

Specifications (measured @ Ta= 25°C, nom. Vin, full load and after warm-up unless otherwise stated)

| ABSOLUTE MAXIMUM RATINGS ⁽³⁾ | | | | |
|---|---|---------|------|--------|
| Parameter | Condition | Min. | Typ. | Max. |
| Absolute Maximum Voltage | +V _{IN} to -V _{IN} | -0.3VDC | | 6VDC |
| | +V _{IN} to -V _{IN} or SGND _{IN} | -0.3VDC | | 6VDC |
| | +V _{OUT} to -V _{OUT} or SGND _{OUT} | -0.3VDC | | 6VDC |
| Operating IC Junction Temperature (T _J) | | | | +150°C |
| Lead Temperature | | | | +260°C |
| Storage Temperature (T _{STO}) | | -65°C | | +150°C |

Notes:

Note3: Stresses beyond those listed under absolute maximum ratings can cause permanent damage to the device. (Values are at non-operating)

Specifications (measured @ Ta= 25°C, nom. Vin, full load and after warm-up unless otherwise stated)

BASIC CHARACTERISTICS

| Parameter | Condition | Min. | Typ. | Max. |
|----------------------------------|-----------|--------|---------|----------|
| Input Voltage Range | | 4.5VDC | 5VDC | 5.5VDC |
| Under Voltage Lockout (UVLO) | DC-DC ON | | 3.28VDC | |
| | DC-DC OFF | | 2.88VDC | |
| Under Voltage Lockout Hysteresis | | | 190mV | |
| Input Current Range | | | 370mA | |
| Quiescent Current | | | 7mA | |
| Minimum Load | | 0% | | |
| Internal Operating Frequency | | | 30MHz | |
| Output Ripple Voltage | | | 50mVp-p | 100mVp-p |

Typical Application Circuit

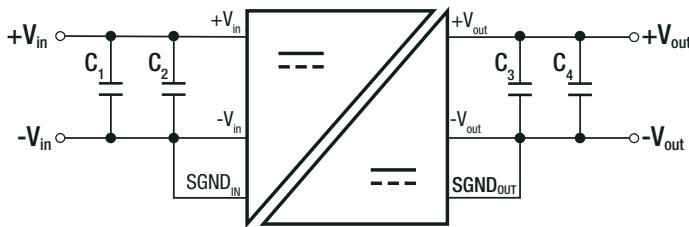

Input and Output Capacitors*

| C ₁ | C ₂ | C ₃ | C ₄ |
|----------------|----------------|----------------|----------------|
| 10µF | 0.1µF | 10µF | 0.1µF |

*these capacitors are mandatory for stable operation

Efficiency vs. Load

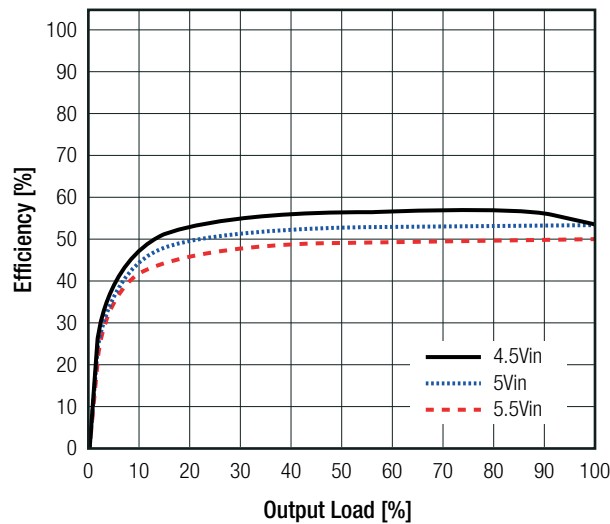

REGULATION

| Parameter | Condition | Min. | Typ. | Max. |
|-------------------------|--|------|-------|------|
| Output Voltage Accuracy | V _{IN} = 4.5-5.5VDC, load= 0A | | ±1.5% | |
| Line Regulation | V _{IN} = 4.75-5.25VDC, load= 0.2A | | ±1.5% | |
| | V _{IN} = 4.5-5.5VDC, load= 0.2A | | ±5.0% | |
| Load Regulation | 0% - 100% load | | 1.0% | |

Specifications (measured @ Ta= 25°C, nom. Vin, full load and after warm-up unless otherwise stated)

| PROTECTIONS | | |
|--------------------------------|---------------------------------|-----------------------------------|
| Parameter | Condition | Values |
| Short Circuit Protection (SCP) | | continuous , hiccup mode |
| Over Current Protection | | 250mA, hiccup mode |
| Over Temperature Protection | | automatic restart after cool down |
| Thermal Shutdown | IC junction temperature | +160°C |
| | hysteresis | +20°C |
| Isolation Voltage | tested for 1second | 3.6kVDC |
| | rated for 1 minute | 3kVDC |
| Isolation Resistance | V _{ISO} = 500VDC, 25°C | 50GΩ typ. |
| Isolation Capacitance | | 7pF typ. |
| Isolation Grade | according to 62368-1 | functional |
| External Clearance | | >8mm |
| External Creepage | | >8mm |

| ENVIRONMENTAL | | |
|----------------------------------|--|------------------------|
| Parameter | Condition | Value |
| Operating Temperature Range | @ natural convection 0.1m/s | -40°C to +125°C |
| ESD | human-body model (HBM), ANSI/ESDA/JEDEC JS-001 | ±6.0kV |
| | charged-device model (CDM), JEDEC JESD22-C101 | ±2.0kV |
| Moisture Sensitive Level | MSL peak temp. ⁽⁵⁾ | Level 3, 260°C, 168hrs |
| Thermal Impedance ⁽⁶⁾ | junction to T _{AMB} | 63.8K/W |
| | junction to case (top) | 21.4K/W |
| | junction to case (bottom) | 37.2K/W |
| | junction to board | 38.5K/W |

Notes:

Note5: The Moisture Sensitivity Level rating according to the JEDEC industry standard classifications, and peak solder temperature

Note6: Tested with 54.0 x 85.6mm 2 layer PCB with 105µm copper

Thermal Derating ⁽⁶⁾

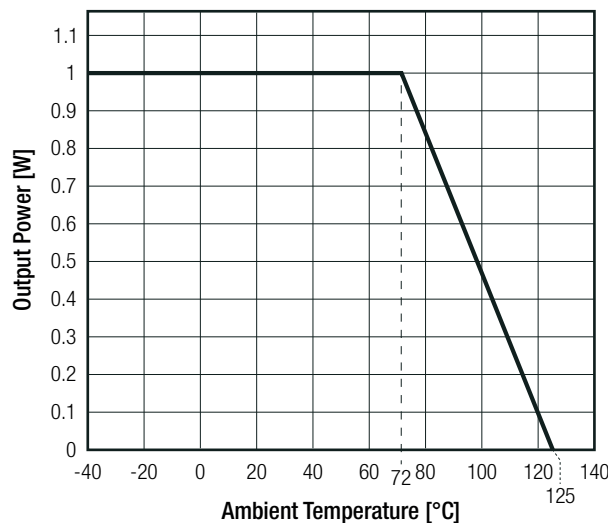

Specifications (measured @ Ta= 25°C, nom. Vin, full load and after warm-up unless otherwise stated)

SAFETY AND CERTIFICATIONS

| Certificate Type (Safety) | Report Number | Standard |
|---|-----------------|--------------------------------|
| Information Technology Equipment, General Requirements for Safety (CB Scheme) | DK-139515-A1-UL | IEC62368-1:2018, 3rd Edition |
| Information Technology Equipment, General Requirements for Safety | S20230116152501 | EN IEC 62368-1:2020 + A11:2020 |
| RoHS2 | | RoHS 2011/65/EU + AM2015/863 |

DIMENSION AND PHYSICAL CHARACTERISTICS

| Parameter | Type | Value |
|-------------------|------|----------------------|
| Dimension (LxWxH) | | 10.35 x 7.5 x 2.50mm |
| Weight | | 0.1g typ. |

Dimension Drawing (mm)

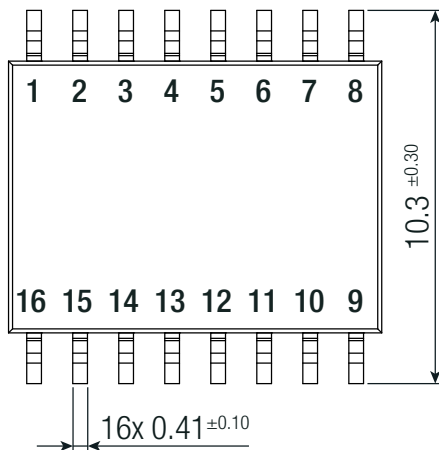
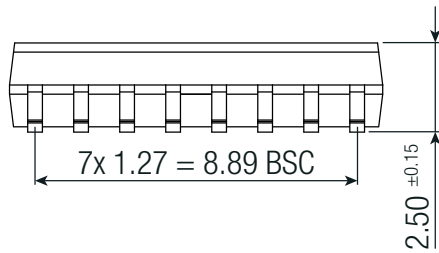
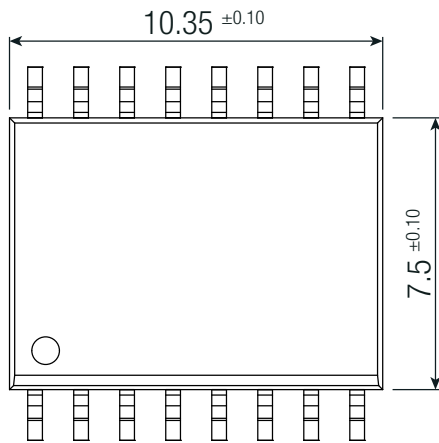
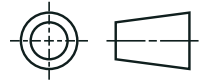

Pin Information

| Pad # | Function |
|---------|----------------------|
| 1,2 | -VIN |
| 3,4 | +VIN |
| 5,6,7,8 | SGND _{IN} |
| 9,11,12 | SGND _{OUT} |
| 10 | DNC (do not connect) |
| 13,14 | +V _{OUT} |
| 15,16 | -V _{OUT} |

Tolerances: x.x= ±0.1mm
x.xx= ±0.05mm

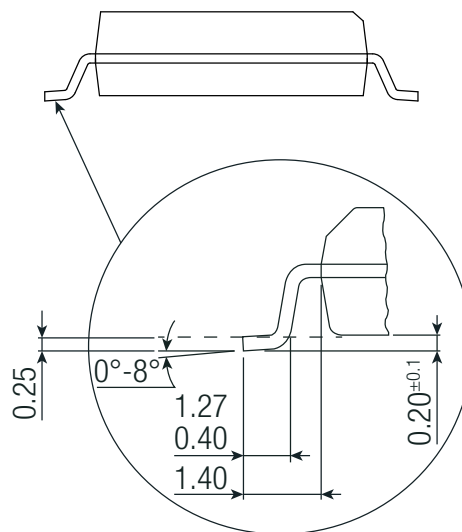

Specifications (measured @ Ta= 25°C, nom. Vin, full load and after warm-up unless otherwise stated)

Footprint Details

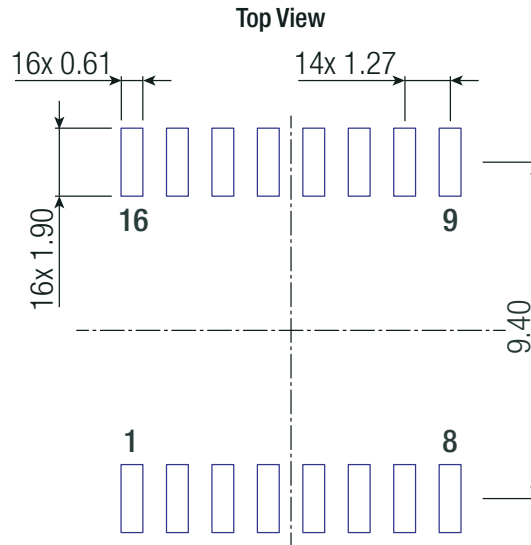

PACKAGING INFORMATION

| Parameter | Type | Value |
|-----------------------------|------------------------------|------------------------|
| Packaging Dimension (LxWxH) | reel (diameter + width) | Ø177.8 + 16.4mm height |
| | tape and reel (carton) | 260.0 x 240.0 x 60.0mm |
| | moisture barrier bag ("-CT") | 100.0 x 100.0 x 30mm |
| Tape Width | | 16mm |
| Packaging Quantity | tape and reel | 500pcs |
| | moisture barrier bag ("-CT") | 10pcs |
| Storage Temperature Range | | -65°C to +150°C |

The product information and specifications may be subject to changes even without prior written notice. The product has been designed for various applications; its suitability lies in the responsibility of each customer. The product is not authorized for use in safety-critical applications without RECOM's explicit written consent. A safety-critical application is an application where a failure may reasonably be expected to endanger or cause loss of life, inflict bodily harm or damage property. The applicant shall indemnify and hold harmless RECOM, its affiliated companies and its representatives against any damage claims in connection with the unauthorized use of RECOM products in such safety-critical applications.