

# V-Series

Sealed Rocker Switches

**PRODUCT WEBPAGE**

*request sample, configure part, watch video*



## Contura® IP66/68 Snap-In Mounted Switches

These switches are a staple in the marine and transportation industries and have passed a range of environmental, corrosion, temperature, vibration, shock and sealing tests including MIL Std 202F, MIL Std 510.1, UL 1500, ISO 8846, IEC 60529 and BS 5490 among others, making them one of the most rugged and reliable switches ever manufactured.

**1-2**  
Poles

**.4-20**  
Amps

**125-250**  
VAC

**12-24**  
VDC

## Typical Applications

- On/Off-Highway
- Armoured Vehicles
- Any Application Requiring Sealing Protection
- Marine
- Mining Machinery

# Design Features

## INTERCHANGEABLE ACTUATORS

Panel redesign is a snap with our wide range of rocker styles. Achieve maximum design variety with minimum inventory. Simply swap rockers to create an entirely new look for your panel.

## DUAL SEAL PROTECTION

Seals out water, dust, debris, and sealed to IP66/68 for above-panel components

## CLEAN CONNECTIONS

Options for both eight and ten terminal base styles with AMP & Packard compatible connectors affords myriad circuit options while providing ease of assembly.

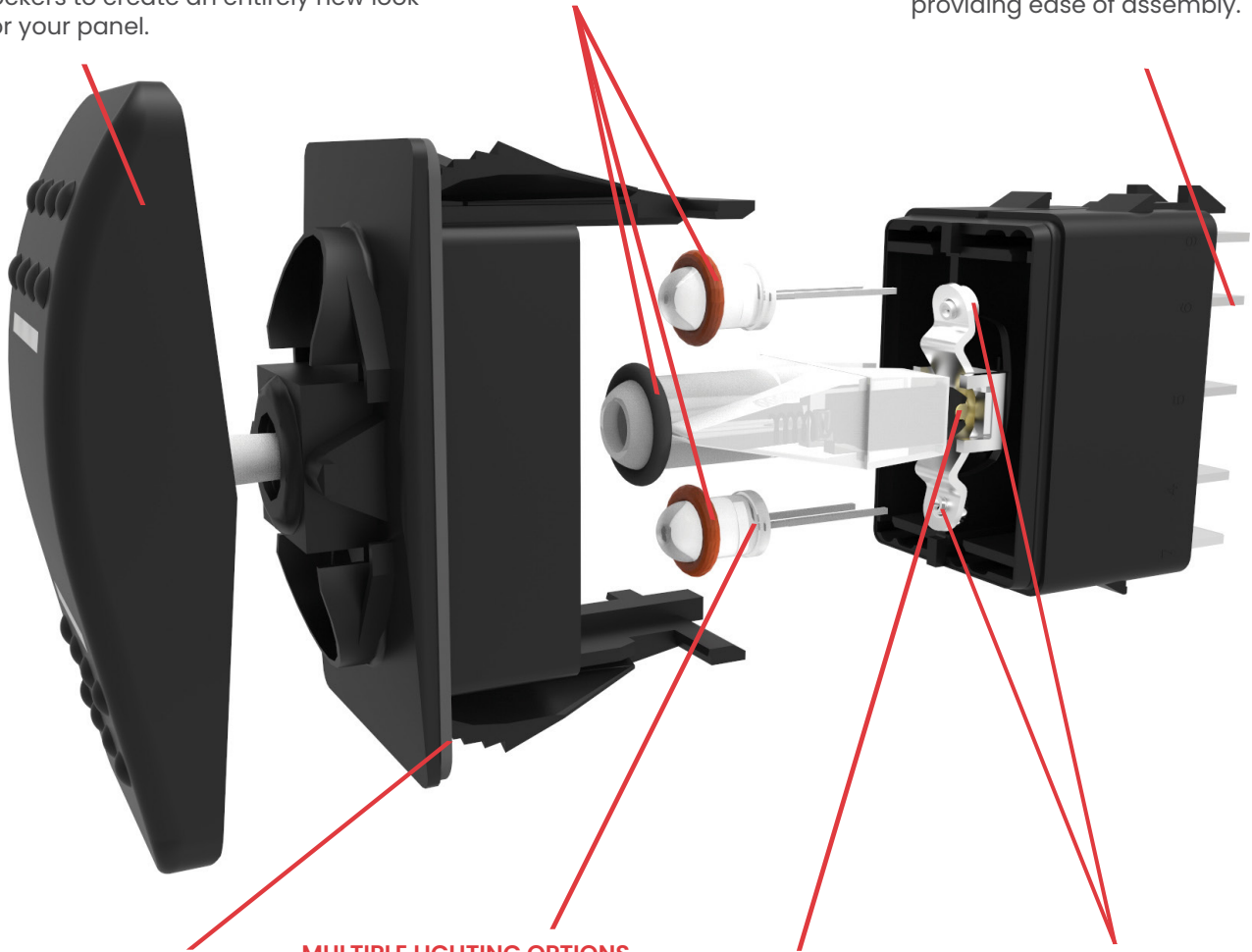

## OPTIONAL PANEL SEAL

Helps prevent water/dust ingress behind panel.

## MULTIPLE LIGHTING OPTIONS

In addition to Incandescent lamps, our LED illumination is offered in a wide array of light intensities, colors, as well as dual level, tri-color, and flashing options.

## BRASS ROLLER PIN

Robust mechanism eliminates the need for lubricants. Enables switch to withstand  $-40^{\circ}\text{C}$  to  $+85^{\circ}\text{C}$  temperatures.

## SILVER PLATED BUTT CONTACT MECHANISM

Providing 50k to 100k electrical cycles, circuit and load dependent

# Actuator Options & Accessories



## Contura II & III

The Contura II & III actuators are constructed of thermoplastic polycarbonate and are offered with a hard nylon overlay or a “soft-touch” elastomer overlay. These models incorporate aesthetic designs on the top and bottom of the rocker featuring two rows of raised “bumps” on the Contura II and three “indented” lines on the Contura III.



## Contura IV

The Contura IV’s “Shape to create a Shape” actuator works with the curves, contours & advanced styling of the latest panel designs, flowing with these advanced curves & radii. This actuator style fits on the Contura flush bracket/bezel.



## Contura V

The symmetrically curved Contura V actuator provides the perfect complement to the Contura IV’s “Shape to create a Shape” design concept. With its flush style mounting bracket, Contura V can be mounted in between two Contura IV’s, by itself, or in groups.



## Contura X

The raised bracket/bezel on the Contura X helps prevent debris from being trapped under the actuator. This curved rocker style is available with a variety of lenses and legends.



## Contura XI

The raised bracket/bezel on the Contura XI helps prevent debris from being trapped under the actuator. This convex style rocker is available with a wide variety of lenses and legends.



## Contura XII

The Contura XII version features a paddle style actuator with the raised bracket/bezel of Contura X and XI. The contoured handle design provides intuitive recognition and ease of operation and is available with all Contura X and XI lens and legend offerings.



## Contura XIV

The Contura XIV represents a sleek new crossover rocker design which should appeal to Trucks, Buses and Heavy Vehicles as well as the Marine Industry. Intuitive feel is provided by recessed ridges along with a Center Groove which effectively defines the boundary between top and bottom switch functions.



## Illuminated Indicators & Accessories

Alert operator of systems functions or malfunctions, are offered with removable/replaceable lamps in Contura II, II, V or X styles. Accessories include connectors, mounting panels, hole plugs, panel seals, and actuator removal tools. Refer to accessories page for full details.

# Tech Specs

## Electrical

Contact Rating	4VA @ 24VDC (MAX) resistive 15 amps, 125VAC 10 amps, 250VAC 1/2 HP 125-250VAC 20 amps, 4-14VDC 15 amps, 15-28VDC 10A, 14VT 6A, 125VAC L
Dielectric Strength	1500 Volts RMS
Insulation Resistance	50 Megohms
Initial Contact Resistance	10 milliohms max. @ 4VDC
Life	Up to 100,000 cycles, circuit and load dependent
Contacts	Silver alloy, silver tin-oxide, fine silver
Terminals	Brass or copper/silver plate 1/4" (6.3mm) Quick Connect terminations standard. Solder lug, Wire Lead

## Physical

Lighted	Incandescent - rated 10,000 hours Neon - rated 25,000 hours LED - rated 100,000 hours 1/2 life (LED is internally ballasted for voltages to 24VDC)
Seals	Internal optional external gasket panel seal
Base	Polyester blend rated to 125°C with a UL flammability rating of 94V0.
Contura II, III, IV, V Actuators	<b>Hard Surface:</b> Basic actuator structure molded of thermoplastic polycarbonate with a hard Nylon 66 thermoplastic surface overlay. <b>Soft Surface:</b> Basic actuator structure molded of thermoplastic polycarbonate with an elastomer overlay.
Contura X, XI, XII Actuators	Nylon 66 Reinforced rated to 105°C
Lens	Polycarbonate rated at 100°C
Contura XIV Actuator	Polycarbonate lens/sub-rocker with ABS shell

## Actuator Travel (Angular Displacement)

2 position	18°
3 positions	9° from center

## Environmental

Sealing	IP66/68, for above-panel components of actual switch only.
Corrosion	Mixed Flowing Gas (MFG) Class III 3 year accelerated exposure per ASTM B-827, B-845 Silver and gold contacts
Operating Temp	-40°C to +85°C
Vibration 1	Per Mil-Std 202F, Method 204D Test Condition A 0.06 DA or 10G's 10-500 Hz. Tested with VCH connector. Test criteria - No loss of circuit during test, pre and post test contact resistance.
Vibration 2	Resonance search 24-50 Hz 0.40 DA 50-2000 Hz ±10 G's peak Horizontal Axis 3-5 G's max. Random 24 Hz 0.06 PSD-Gsq/Hz 60 Hz 0.50 100 Hz 0.50 200 Hz 0.025 2000 Hz 0.025 No loss of circuit during test; <10µ seconds chatter.
Shock	Per Mil-Std 202F, Method 213B, Test Condition K @ 30G's. Tested with VCH connector. Test criteria - No loss of circuit during test, pre and post test contact resistance.
Salt Spray	Per Mil-Std 202F, Method 101D, Test Condition A, 96 Hrs. Sealed version only.
Dust	Mil STD 810, Method 510.2 Air Velocity 300 Ft/Min Duration 16Hr
Thermal Shock	Per Mil-Std 202F, Method 107F, Test Cond. A, -55°C to +85°C. Test criteria -pre and post test contact resistance
Moisture Resistance	Per Mil-Std 202F, Method 106F, Test Criteria - pre and post test contact resistance
Ignition Protection	All Contura switches with sealed construction meet the requirements of UL1500/ISO8846 for ignition protection, in addition to conformance with EC directive 94/25/EC for marine products.

## Mounting Specifications

Panel Thickness Range  
Gaskets Acceptable Panel Thickness

0	.030 to .250 (.76 to 6.35mm)
1	.030 to .109 & .147 to .157 (.76 to 2.77mm & 3.73 to 3.98mm)

Recommended: No gasket with panel thickness of .032, .062, .093, .125, .187 or .250

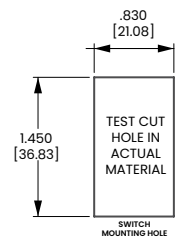

# Ordering Scheme

Contura II & III

Sample Part Number

V 1 D A B T 0 B - A R B 00 - 0 00

Selection

1 2 3 4 5 6 7 8 9 10 11 12 13 14

## 1. SERIES

V V-Series

## 2. CIRCUIT

Terminal Connections as viewed ( ) - momentary from bottom of switch: SP - single pole: terminals 1, 2 & 3.  
**8 terminal** **10 terminal** DP - double pole: terminals 1, 2, 3, 4, 5 & 6.  
 Terminals 7, 8, 9 & 10 for lamp circuit only.

8 - 7 8 - 7  
 1 - 4 1 - 4  
 2 - 5 2 - 5  
 3 - 6 3 - 6  
 10 - 9

Position:	1	2	3
SP DP	2 & 3, 5 & 6	Connected Terminals	1 & 2, 4 & 5
1 A	ON	NONE	OFF
2 B	(ON)	NONE	OFF
3 C	ON	NONE	(OFF)
4 D	ON	NONE	ON
5 F	ON	NONE	(ON)
6 J	ON	OFF	ON
7 K	ON	OFF	(ON)
8 L	(ON)	OFF	(ON)

### SPECIAL CIRCUITS

H*	2 & 3	2 & 3, 5 & 4	5 & 4
G*	2 & 3, 5 & 6	2 & 3	OFF
S*	2 & 3, 5 & 6	2 & 3	1 & 2
M*	(2 & 3, 5 & 6)	2 & 3	OFF
R*	(2 & 3, 5 & 6)	2 & 3	2 & 1
E*	5 & 6	5 & 3	5 & 1

Jumper between terminals 2 & 5 for circuits H,G,M,R & S are specified in selection 4. External jumper between terminals 2 & 4 for circuit E are provided by customer. Circuit E may be used for SP OFF-ON-ON circuit.

## 3. RATING

1	.4VA @ 28VDC Resistive
5	10A 250VAC 1/2 HP, 15A 125 VAC 1/2 HP, UL Recog., CSA Certified
B	15A 24V
C	20A 18V
D	20A 12V
E	20A 14V, 10A 14VT (circuit 1, 4, A & D only)
F	10A 14V, 6A 14VT (circuit G only)

## 4. TERMINATION / BASE STYLE

8 term	10 Term	Termination	Jumper
1	2	.250 TAB (QC) no barriers	No
A	B	.250 TAB (QC) with barriers	No
J	K	.250 TAB (QC) no barriers	Yes T2 to 5
3	4	Solder Lug no barriers	No
C	D	Solder Lug	No
5	6	Wire Leads no barriers	No
E	F	Wire Leads	No

Note: Codes J & K for circuits H, G & M. Do not use silicone based lubricants to reduce terminal insertion forces during connector assembly, as it is detrimental to function and performance.

## 5. ILLUMINATION

Lamp #1: above terminals 1 & 4 end of switch.; Lamp #2 above terminals 3 & 6 end of switch. Positive (+) and negative (-) symbols apply to LED lamps only

Sealed	Lamps	Illumination Type	Lamp wired to Terminals
S	NONE		
A	1	INDEPENDENT	8 (+) 7 (-)
B	1	DOWN	3 (+) 7 (-)
C	2	UP	3 (+) 7 (-)
D	1	DOWN	3 (+) 7 (-)
E	2	DOWN	1 (+) 7 (-)
F	1	UP	1 (+) 7 (-)
G	2	UP	3 (+) 7 (-)
H	1	INDEPENDENT	8 (+) 7 (-)
U	2	UP	3 (+) 7 (-)
	2	INDEPENDENT	8 (+) 7 (-)
	2	INDEPENDENT	10 (+) 9 (-)
SINGLE POLE SWITCHES ONLY			
J	1	DOWN	3 (+) 8 (-)
K	2	INDEPENDENT	6 (+) 7 (-)
L	1	INDEPENDENT	8 (+) 7 (-)
M	2	INDEPENDENT	6 (+) 7 (-)
DOUBLE POLE SWITCHES ONLY			
L	1	DOWN	3 (+) 6 (-)
M	1	UP	3 (+) 6 (-)
N	1	DOWN	3 (+) 6 (-)
P	2	DOWN	1 (+) 4 (-)
	1	UP	1 (+) 4 (-)
	2	UP	3 (+) 6 (-)

## 6,7. LAMP (SAME CODING FOR BOTH SELECTIONS)

Selection 6: above terminals 1 & 4; Selection 7: above terminals 3 & 6  
 No lamp 0  
 Neon 1 125VAC 2 250VAC





LED*	Red	Amber	superbright Green	superbright Red
2VDC	A	L	F	R
12VDC	C	N	H	T
24VDC	D	P	J	V

\* Consult factory for "daylight bright" LED options. Typical current draw for LED is 20ma.

## 8. FLUSH BRACKET COLOR, PANEL SEAL

No Seal	Black
One Seal	B
	C

## 9. ACTUATOR

0	No Actuator		
A, B	Contura II		
C, D	Contura III		

Actuator thick end over terminals: 1,4 3,6

## 10. LENS

0 - No Actuator	White	Z - No Lens	Amber	Green	Red	Blue
1	6	B	G	M	T	
2	7	C	H	N	U	
3	8	D	J	P	V	

Square lens options only available for Contura II.

4	9	E	K	R	W
5	A	F	L	S	Y

Lens color for LEDs must be clear, white, or match color of LED. Green or blue lenses are not recommended with Neon lamps.

## 11. ACTUATOR COLOR AND TEXTURE

0 - No Actuator	Black	Red
Soft Surface	B	R
Hard Surface	C	S

## 12. ACTUATOR LENS OR BODY LEGENDS

11	ON	12	OFF	13	I	14	O
	OFF		ON		O		I
15	O O	16	O O	17	O I	18	I O
	F N		N F		F		F

For additional legend options & codes, visit us at [www.carlingtech.com](http://www.carlingtech.com)

## 13. LEGENDS ORIENTATION

0	No legend (used with codes 11-18 in selection 12)
1	Orientation 1
2	Orientation 2
3	Orientation 3
4	Orientation 4

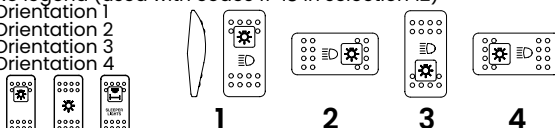

## 14. ACTUATOR LENS LEGENDS

00 No legend this location / no actuator (used with codes 11-18 in selection 12) Selection 14 required when switch requires two legends. If the two legends consist of one lens and one body legend, lens legend must be specified in selection 12; body legend specified in selection 14. For legend options & codes, visit us at [www.carlingtech.com](http://www.carlingtech.com).

### Notes:

- Consult factory to verify horsepower rating for your particular circuit choice.
- Custom colors are available. Consult factory.
- Body legends not available on Soft surface actuators; White imprinting is standard on black actuators; Black imprinting is standard on white, red and gray actuators. Custom colors are available, consult factory.
- Additional ratings available. See V-Series Switch Accessories page.
- Contura II available with two square lenses. Consult factory for details.

Configure Complete Part Number >

Browse Standard Parts >

# Ordering Scheme

Contura II & III locking

Sample Part Number V 1 D A S W 0 B A Z E 00 - 0

Selection 1 2 3 4 5 6 7 8 9 10 11 12 13

## 1. SERIES

V V-Series

## 2. CIRCUIT

Terminal Connections as viewed ( ) - momentary from bottom of switch: SP - single pole: terminals 1, 2 & 3. DP - double pole: terminals 1, 2, 3, 4, 5 & 6. Terminals 7, 8, 9 & 10 for lamp circuit only.

8 terminal 10 terminal  
 8 -- 7 8 -- 7  
 1 -- 4 1 -- 4  
 2 -- 5 2 -- 5  
 3 -- 6 3 -- 6  
 10 -- 9

Position:	1	2	3
SP DP	2 & 3, 5 & 6	Connected Terminals	1 & 2, 4 & 5
1 A	ON	NONE	OFF
4 D	ON	NONE	ON
6 J	ON	OFF	ON
7 K	ON	OFF	(ON)
8 L	(ON)	OFF	(ON)
9 N	OFF	NONE	ON

SPECIAL CIRCUITS	2 & 3	2 & 3, 5 & 4	5 & 4
H*	2 & 3	2 & 3, 5 & 4	5 & 4
G*	2 & 3, 5 & 6	2 & 3	OFF
S*	2 & 3, 5 & 6	2 & 3	1 & 2
M*	(2 & 3, 5 & 6)	2 & 3	OFF
R*	(2 & 3, 5 & 6)	2 & 3	2 & 1
E*	5 & 6	5 & 3	5 & 1

\*Jumper between terminals 2 & 5 for circuits H,G,M,R & S are specified in selection 4. External jumper between terminals 2 & 4 for circuit E are provided by customer. Circuit E may be used for SP OFF-ON-ON circuit.

## 3. RATING

1	.4VA @ 28VDC Resistive
5	10A 250VAC 1/2 HP, 15A 125 VAC 1/2 HP, UL Recog., CSA Certified
B	15A 24V
C	20A 18V
D	20A 12V
E	20A 14V, 10A 14VT (circuit 1, 4, A & D only)
F	10A 14V, 6A 14VT (circuit G only)

## 4. TERMINATION / BASE STYLE

8 term	10 Term	Termination	Jumper
1	2	.250 TAB (QC) no barriers	No
A	B	.250 TAB (QC) with barriers	No
J	K	.250 TAB (QC) no barriers	Yes T2 to 5
3	4	Solder Lug no barriers	No
C	D	Solder Lug	No
5	6	Wire Leads no barriers	No
E	F	Wire Leads	No

Note: Codes J & K for circuits H, G & M. Do not use silicone based lubricants to reduce terminal insertion forces during connector assembly, as it is detrimental to function and performance.

## 5. ILLUMINATION & SWITCH SEALING

3 & 6 end of switch. Positive (+) and negative (-) symbols apply to LED lamps only

Sealed Lamps	ILLUMINATION Type	Lamp wired to Terminals
S NONE	-	-
C 2	UP	3 (+) 7 (-)
H 2	INDEPENDENT	8 (+) 7 (-)
DOUBLE POLE SWITCHES ONLY		
M 1	UP	3 (+) 6 (-)
2	DOWN	1 (+) 4 (-)
P 1	UP	1 (+) 4 (-)
2	UP	3 (+) 6 (-)

## 6. LOCK

Lock above terminals 1 & 4 end of switch  
 W lock

## 7. LAMP

Lamp above terminals 3 & 6 end of switch  
 No lamp 0  
 Neon 1 125VAC 2 250VAC

LED*	Red	Amber	superbright Green	superbright Red
2VDC	A	L	F	R
12VDC	C	N	H	T
24VDC	D	P	J	V

\* Consult factory for "daylight bright" LED options. Typical current draw for LED is 20ma.

## 8. FLUSH BRACKET COLOR, PANEL SEAL

No Seal Black  
 B  
 One Seal C

## 9. HARD SURFACE ACTUATOR

Contura II Black Red  
 A G  
 Contura III C E

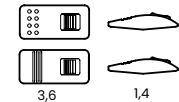

Actuator orientation above terminals:

## 10. LENS

Z - No Lens  
 Clear White Amber Green Red Blue  
 3 B D J P V



Lens color for LEDs must be clear, white, or match color of LED. Green or blue lenses are not recommended with Neon lamps.

## 11. ACTUATOR LOCK FUNCTION AND COLOR

Lock Color	Up	Down	Up & Down	Center <sup>3</sup>
Match Actuator	A	H	R	1
Black	B	J	S	2
White	C	K	T	3
Red	D	L	V	4
Safety Orange	E	M	W	5

## 12. ACTUATOR LENS OR BODY LEGENDS

00 - No Legend  
 21 OFF 22 ON 23 O 24 I  
 25 O 26 O 27 O 28 I  
 F N  
 F



For additional legend options & codes, visit us at [www.carlingtech.com](http://www.carlingtech.com)

## 13. LEGEND ORIENTATION

0 No Legend (used with codes 21-28 in selection 12)  
 1 Orientation 1  
 2 Orientation 2  
 3 Orientation 3  
 4 Orientation 4

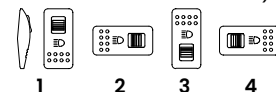

Notes: Consult factory to verify horsepower rating for your particular circuit choice.

- 1 Custom colors are available. Consult factory.
- 2 White imprinting is standard on black actuators; Black imprinting is standard on white, red and gray actuators. Custom colors are available, consult factory.
- 3 Only available with 3 position circuits. Center OFF and special circuits only available with center position lock function.
- 4 Additional ratings available. See V-Series Switch Accessories page.

[Configure Complete Part Number >](#)

[Browse Standard Parts >](#)

# Ordering Scheme

Contura IV

Sample Part Number

V 1 D A B T 0 B - E P C 00 - 0 00

Selection 1 2 3 4 5 6 7 8 9 10 11 12 13 14

## 1. SERIES

V V-Series

## 2. CIRCUIT

Terminal Connections as viewed ( ) - momentary from bottom of switch: SP - single pole: terminals 1, 2 & 3.  
**8 terminal** **10 terminal** DP - double pole: terminals 1, 2, 3, 4, 5 & 6.  
 Terminals 7, 8, 9 & 10 for lamp circuit only.

8 -- 7 8 -- 7  
 1 -- 4 1 -- 4  
 2 -- 5 2 -- 5  
 3 -- 6 3 -- 6  
 10 -- 9

Position:	1	2	3
SP DP	2 & 3, 5 & 6	Connected Terminals	1 & 2, 4 & 5
1 A	ON	NONE	OFF
2 B	(ON)	NONE	OFF
3 C	ON	NONE	(OFF)
4 D	ON	NONE	ON
5 F	ON	NONE	(ON)
6 J	ON	OFF	(ON)
7 K	ON	OFF	(ON)
8 L	(ON)	OFF	(ON)

SPECIAL CIRCUITS	1	2	3
H*	2 & 3	2 & 3, 5 & 4	5 & 4
G*	2 & 3, 5 & 6	2 & 3	OFF
S*	2 & 3, 5 & 6	2 & 3	1 & 2
M*	(2 & 3, 5 & 6)	2 & 3	OFF
R*	(2 & 3, 5 & 6)	2 & 3	2 & 1
E*	5 & 6	5 & 3	5 & 1

\*Jumper between terminals 2 & 5 for circuits H,G,M,R & S are specified in selection 4. External jumper between terminals 2 & 4 for circuit E are provided by customer. Circuit E may be used for SP OFF-ON-ON circuit.

## 3. RATING 4

1	.4VA @ 28VDC Resistive
5	10A 250VAC 1/2 HP, 15A 125 VAC 1/2 HP, UL Recog., CSA Certified
B	15A 24V
C	20A 18V
D	20A 12V
E	20A 14V, 10A 14VT (circuit 1, 4, A & D only)
F	10A 14V, 6A 14VT (circuit G only)

## 4. TERMINATION / BASE STYLE

8 term	10 Term	Termination	Jumper
1	2	.250 TAB (QC) no barriers	No
A	B	.250 TAB (QC) with barriers	No
J	K	.250 TAB (QC) no barriers	Yes T2 to 5
3	4	Solder Lug no barriers	No
C	D	Solder Lug	No
5	6	Wire Leads no barriers	No
E	F	Wire Leads	No

Note: Codes J & K for circuits H, G & M. Do not use silicone based lubricants to reduce terminal insertion forces during connector assembly, as it is detrimental to function and performance.

## 5. ILLUMINATION & SWITCH SEALING

Lamp #1: above terminals 1 & 4 end of switch.; Lamp #2 above terminals 3 & 6 end of switch. Positive (+) and negative (-) symbols apply to LED lamps only

Sealed	Lamps	illumination Type	Lamp wired to Terminals
S	NONE		
A	1	INDEPENDENT	8 (+) 7 (-)
B	1	DOWN	3 (+) 7 (-)
C	2	UP	3 (+) 7 (-)
D	1	DOWN	3 (+) 7 (-)
E	2	DOWN	1 (+) 7 (-)
F	1	UP	1 (+) 7 (-)
G	2	UP	3 (+) 7 (-)
H	1	INDEPENDENT	8 (+) 7 (-)
I	2	UP	3 (+) 7 (-)
J	1	INDEPENDENT	8 (+) 7 (-)
K	2	UP	3 (+) 7 (-)
L	1	INDEPENDENT	8 (+) 7 (-)
M	2	UP	3 (+) 7 (-)
N	1	INDEPENDENT	8 (+) 7 (-)
O	2	UP	3 (+) 7 (-)
P	1	INDEPENDENT	8 (+) 7 (-)
Q	2	UP	3 (+) 7 (-)

SINGLE POLE SWITCHES ONLY	Lamps	illumination Type	Lamp wired to Terminals
J	1	DOWN	3 (+) 8 (-)
K	2	INDEPENDENT	6 (+) 7 (-)
L	1	INDEPENDENT	8 (+) 7 (-)
M	2	UP	6 (+) 7 (-)

DOUBLE POLE SWITCHES ONLY	Lamps	illumination Type	Lamp wired to Terminals
L	1	DOWN	3 (+) 6 (-)
M	1	UP	3 (+) 6 (-)
N	1	DOWN	3 (+) 6 (-)
O	2	DOWN	1 (+) 4 (-)
P	1	UP	1 (+) 4 (-)
Q	2	UP	3 (+) 6 (-)

## 6,7. LAMP (SAME CODING FOR BOTH SELECTIONS)

Selection 6: above terminals 1 & 4; Selection 7: above terminals 3 & 6

No lamp	0			
Neon	1	125VAC	2	250VAC
LED*				superbright superbright
		Red	Amber	Green Red
2VDC	A	L	F	R
12VDC	C	N	H	T
24VDC	D	P	J	V

\* Consult factory for "daylight bright" LED options. Typical current draw for LED is 20ma.

## 8. FLUSH BRACKET COLOR, PANEL SEAL 1

No Seal	Black
One Seal	B
	C

## 9. ACTUATOR

E	Contura IV, left orientation	
T	Contura IV, left orientation, laser etched	
F	Contura IV, right orientation	
R	Contura IV, right orientation, laser etched	

Actuator orientation over terminals:

## 10. LENS

0 - No Actuator	Z - No Lens
Clear White Amber Green Red	Blue
1 6 B G M T	
2 7 C H N U	
3 8 D J P V	
4 9 E K R W	
5 A F L S Y	



Lens color for LEDs must be clear, white, or match color of LED. Green or blue lenses are not recommended with Neon lamps.

## 11. ACTUATOR COLOR 1, 5, 6

No Actuator	0	Black	C	Red	S
Nickel	D	Pewter	E		

## 12. ACTUATOR LENS OR BODY LEGENDS 2

11	ON	12	OFF	13	I	14	O
	OFF		ON		O		I
15	O O	16	O O	17	O I	18	I O
	F N		N F		F		F



For additional legend options & codes, visit us at [www.carlingtech.com](http://www.carlingtech.com)

## 13. LEGENDS ORIENTATION

0	No legend (used with codes 11-18 in selection 12)
1	Orientation 1
2	Orientation 2
3	Orientation 3
4	Orientation 4

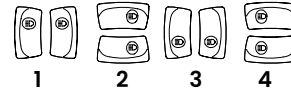

## 13. ACTUATOR LENS LEGENDS

00 No legend this location / no actuator (used with codes 11-18 in selection 12) Selection 14 required when switch requires two legends. If the two legends consist of one lens and one body legend, lens legend must be specified in selection 12; body legend specified in selection 14. For legend options & codes, visit us at [www.carlingtech.com](http://www.carlingtech.com).

Notes:

- Consult factory to verify horsepower rating for your particular circuit choice.
- Custom colors are available. Consult factory.
- White imprinting is standard on black actuators; Black imprinting is standard on white, red and gray actuators. Custom colors are available, consult factory.
- Gloss brow is on left side of E actuator and right side of F actuator.
- Additional ratings available. See V-Series Switch Accessories page.
- Laser etched rocker only available with lenses code Z & actuator colors black, nickel or pewter.
- Pewter and nickel colors only available with laser etched actuator.

[Configure Complete Part Number >](#)

[Browse Standard Parts >](#)

# Ordering Scheme

Contura V

Sample Part Number

V 1 D A B T 0 B - G P C 00 - 0 00

Selection 1 2 3 4 5 6 7 8 9 10 11 12 13 14

## 1. SERIES

V V-Series

## 2. CIRCUIT

Terminal Connections as viewed ( ) - momentary from bottom of switch: SP - single pole: terminals 1, 2 & 3.  
 8 terminal 10 terminal DP - double pole: terminals 1, 2, 3, 4, 5 & 6.  
 8 - 7 8 - 7 Terminals 7, 8, 9 & 10 for lamp circuit only.

1 - - 4	1 - - 4	
2 - - 5	2 - - 5	
3 - - 6	3 - - 6	
	10 - - 9	
<b>Position:</b>		
<b>SP DP</b>	<b>1</b>	<b>2</b>
1 A	2 & 3, 5 & 6	2 & 3, 5 & 6
2 B	(ON)	Connected Terminals
3 C	(ON)	1 & 2, 4 & 5
4 D	(ON)	NONE
5 F	(ON)	NONE
6 J	(ON)	NONE
7 K	(ON)	OFF
8 L	(ON)	OFF
<b>SPECIAL CIRCUITS</b>		
H*	2 & 3	2 & 3, 5 & 4
G*	2 & 3, 5 & 6	2 & 3
S*	2 & 3, 5 & 6	2 & 3
M*	(2 & 3, 5 & 6)	2 & 3
R*	(2 & 3, 5 & 6)	2 & 3
E*	5 & 6	5 & 3

\*Jumper between terminals 2 & 5 for circuits H,G,M,R & S are specified in selection 4. External jumper between terminals 2 & 4 for circuit E are provided by customer. Circuit E may be used for SP OFF-ON-ON circuit.

## 3. RATING

1	.4VA @ 28VDC Resistive
5	10A 250VAC 1/2 HP, 15A 125 VAC 1/2 HP, UL Recog., CSA Certified
B	15A 24V
C	20A 18V
D	20A 12V
E	20A 14V, 10A 14VT (circuit 1, 4, A & D only)
F	10A 14V, 6A 14VT (circuit G only)

## 4. TERMINATION / BASE STYLE

8 term	10 Term	Termination	Jumper
1	2	.250 TAB (QC) no barriers	No
A	B	.250 TAB (QC) with barriers	No
J	K	.250 TAB (QC) no barriers	Yes T2 to 5
3	4	Solder Lug no barriers	No
C	D	Solder Lug	No
5	6	Wire Leads no barriers	No
E	F	Wire Leads	No

Note: Codes J & K for circuits H, G & M. Do not use silicone based lubricants to reduce terminal insertion forces during connector assembly, as it is detrimental to function and performance.

## 5. ILLUMINATION & SWITCH SEALING

Lamp #1: above terminals 1 & 4 end of switch.; Lamp #2 above terminals 3 & 6 end of switch. Positive (+) and negative (-) symbols apply to LED lamps only

Sealed	Lamps	illumination Type	Lamp wired to Terminals
S	NONE	-	-
A	1	INDEPENDENT	8 (+) 7 (-)
B	1	DOWN	3 (+) 7 (-)
C	2	UP	3 (+) 7 (-)
D	1	DOWN	3 (+) 7 (-)
	2	DOWN	1 (+) 7 (-)
E	1	UP	1 (+) 7 (-)
	2	UP	3 (+) 7 (-)
F	1	INDEPENDENT	8 (+) 7 (-)
	2	UP	3 (+) 6 (-)
G	1	INDEPENDENT	8 (+) 7 (-)
	2	UP	3 (+) 7 (-)
H	2	INDEPENDENT	8 (+) 7 (-)
U	1	INDEPENDENT	8 (+) 7 (-)
	2	INDEPENDENT	10 (+) 9 (-)
<b>SINGLE POLE SWITCHES ONLY</b>			
J	1	DOWN	3 (+) 8 (-)
	2	INDEPENDENT	6 (+) 7 (-)
K	1	INDEPENDENT	8 (+) 7 (-)
	2	INDEPENDENT	6 (+) 7 (-)
<b>DOUBLE POLE SWITCHES ONLY</b>			
L	1	DOWN	3 (+) 6 (-)
M	1	UP	3 (+) 6 (-)
N	1	DOWN	3 (+) 6 (-)
	2	DOWN	1 (+) 4 (-)
P	1	UP	1 (+) 4 (-)
	2	UP	3 (+) 6 (-)

## 6,7. LAMP

Selection 6: above terminals 1 & 4; Selection 7: above terminals 3 & 6  
 No lamp 0  
 Neon 1 125VAC 2 250VAC

LED*	Red	Amber	superbright Green	superbright Red
2VDC	A	L	F	R
12VDC	C	N	H	T
24VDC	D	P	J	V

\* Consult factory for "daylight bright" LED options. Typical current draw for LED is 20ma.

## 8. FLUSH BRACKET COLOR, PANEL SEAL

No Seal	Black
One Seal	B
	C

## 9. ACTUATOR

0	No Actuator
G	Contura V
P	Contura V, laser etched

## 10. LENS

0 - No Actuator	Z - No Lens	style & location: #1 / #2
Clear	White	Amber
1	6	B
2	7	C
3	8	D
4	9	E
5	A	F
		G
		H
		J
		K
		L
		M
		N
		P
		R
		S
		T
		U
		V
		W
		Y

Green or blue lenses are not recommended with Neon lamps.

## 11. ACTUATOR COLOR

No Actuator	0	Black	C	Red	S
Nickel	D	Pewter	E		

## 12. ACTUATOR LENS OR BODY LEGENDS

11	ON	12	OFF	13	I	14	O
	OFF		ON		O		I
15	O O	16	O O	17	O I	18	I O
	F N		N F				
	F		F				

For additional legend options & codes, visit us at [www.carlingtech.com](http://www.carlingtech.com)

## 12. LEGENDS ORIENTATION

0	No legend (used with codes 11-18 in selection 12)
1	Orientation 1
2	Orientation 2
3	Orientation 3
4	Orientation 4

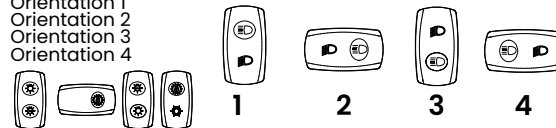

## 13. ACTUATOR LENS LEGEND

00 No legend this location / no actuator (used with codes 11-18 in selection 12) Selection 14 required when switch requires two legends. If the two legends consist of one lens and one body legend, lens legend must be specified in selection 12; body legend specified in selection 14. For legend options & codes, visit us at [www.carlingtech.com](http://www.carlingtech.com)

- Notes:
- Consult factory to verify horsepower rating for your particular circuit choice.
  - Custom colors are available. Consult factory.
  - White imprinting is standard on black actuators; Black imprinting is standard on white, red and gray actuators. Custom colors are available, consult factory.
  - Laser Etched rocker only available with lens code Z & actuator colors black, nickel or pewter.
  - Additional ratings available. See V-Series Switch Accessories page.
  - Nickel and Pewter colors only available with laser etched actuator.
  - Consult factory for laser etched lens callout.

[Configure Complete Part Number >](#)

[Browse Standard Parts >](#)

# Ordering Scheme

Contura IV & V Locking

Sample Part Number

V 1 D A S W 0 B - J Z E 00 - 0

Selection

1 2 3 4 5 6 7 8 9 10 11 12 13

## 1. SERIES

V V-Series

## 2. CIRCUIT 3

Terminal Connections as viewed ( ) - momentary from bottom of switch: SP - single pole: terminals 1, 2 & 3.  
 8 terminal 10 terminal DP - double pole: terminals 1, 2, 3, 4, 5 & 6.  
 8 -- 7 8 -- 7 Terminals 7, 8, 9 & 10 for lamp circuit only.  
 1 - 4 1 - 4  
 2 - 5 2 - 5  
 3 - 6 3 - 6  
 10 - 9

Position:	1	2	3
SP DP	2 & 3, 5 & 6	Connected Terminals	1 & 2, 4 & 5
1 A	ON	NONE	OFF
4 D	ON	NONE	ON
6 J	ON	OFF	ON
7 K	ON	OFF	(ON)
8 L	(ON)	OFF	(ON)
9 N	OFF	NONE	ON

## 3. RATING 4

1	.4VA @ 28VDC Resistive
5	10A 250VAC 1/2 HP, 15A 125 VAC 1/2 HP, UL Recog., CSA Certified
B	15A 24V
C	20A 18V
D	20A 12V
E	20A 14V, 10A 14VT (circuit 1, 4, A & D only)
F	10A 14V, 6A 14VT (circuit G only)

## 4. TERMINATION / BASE STYLE

8 term	10 Term	Termination	Jumper
1	2	.250 TAB (QC) no barriers	No
A	B	.250 TAB (QC) with barriers	No
J	K	.250 TAB (QC) no barriers	Yes T2 to 5
3	4	Solder Lug no barriers	No
C	D	Solder Lug	No
5	6	Wire Leads no barriers	No
E	F	Wire Leads	No

Note: Codes J & K for circuits H, G & M. Do not use silicone based lubricants to reduce terminal insertion forces during connector assembly, as it is detrimental to function and performance.

## 5. ILLUMINATION & SWITCH SEALING

Lamp #1: above terminals 1 & 4 end of switch.; Lamp #2 above terminals 3 & 6 end of switch. Positive (+) and negative (-) symbols apply to LED lamps only

Sealed	Lamps	illumination Type	Lamp wired to Terminals
S	NONE	-	-
C	2	UP	3 (+) 7 (-)
H	2	INDEPENDENT	8 (+) 7 (-)
DOUBLE POLE SWITCHES ONLY			
M	1	UP	3 (+) 6 (-)

## 6. LOCK

Lock above terminals 1 & 4 end of switch.  
 W low profile lock Y 6 high profile lock

Notes: Consult factory to verify horsepower rating for your particular circuit choice.

- Custom colors are available. Consult factory.
- White imprinting is standard on black actuators; Black imprinting is standard on white, red and gray actuators. Custom colors are available, consult factory.
- Only available with 3 position circuits. Center OFF and special circuits only available with center position lock function.
- Additional ratings available. See V-Series Switch Accessories page.
- Located at T3-6 end of switch.
- Contura V style only.

Configure Complete Part Number >

Browse Standard Parts >

## 7. LAMP

Lamp above terminals 3 & 6 end of switch

No lamp 0  
 Neon 1 125VAC 2 250VAC

LED*	Red	Amber	superbright Green	superbright Red
2VDC	A	L	F	R
12VDC	C	N	H	T
24VDC	D	P	J	V

\* Consult factory for "daylight bright" LED options. Typical current draw for LED is 20ma.

## 8. FLUSH BRACKET COLOR, PANEL SEAL 1

No Seal Black  
 One Seal B  
 C

## 9. HARD SURFACE ACTUATOR

CONTURA IV:  
 Orientation Black Red  
 Left J L  
 Right N R



Actuator orientation over terminals: 3,6 1,4

CONTURA V:  
 Black Red  
 U W



Actuator orientation over terminals: 3,6 1,4

## 10. LENS 5

Z - No Lens  
 Clear White Amber Green Red Blue  
 A B C D E F bar lens  
 G H J K L M oval lens

Lens color for LEDs must be clear, white, or match color of LED. Green or blue lenses are not recommended with Neon lamps.

## 11. ACTUATOR LOCK FUNCTION AND COLOR 1

Lock Color	Up	Down	Up & Down	Center <sup>3</sup>
Match Actuator	A	H	R	1
Black	B	J	S	2
White	C	K	T	3
Red	D	L	V	4
Safety Orange	E	M	W	5
Gray	F	G	N	6

## 12. ACTUATOR LENS OR BODY LEGENDS 2

00 - No Legend  
 21 22 23 24  
 OFF ON O I  
 25 O 26 O 27 O 28 I  
 F N



For additional legend options & codes, visit us at [www.carlingtech.com](http://www.carlingtech.com)

## 13. LEGENDS ORIENTATION

0 No legend  
 1 Orientation 1  
 2 Orientation 2  
 3 Orientation 3  
 4 Orientation 4

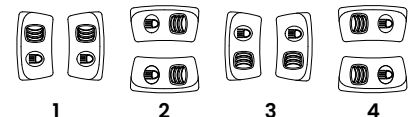

# Ordering Scheme

Contura X, XI & XII

Sample Part Number

V 1 D A B 6 0 1 - 6 P Z 00 - 0 00

Selection

1 2 3 4 5 6 7 8 9 10 11 12 13 14

## 1. SERIES

V V-Series

## 2. CIRCUIT

Terminal Connections as viewed ( ) - momentary from bottom of switch: SP - single pole: terminals 1, 2 & 3.  
**8 terminal 10 terminal** DP - double pole: terminals 1, 2, 3, 4, 5 & 6.  
 8 -- 7 8 -- 7 Terminals 7, 8, 9 & 10 for lamp circuit only.  
 1 - 4 1 - 4  
 2 - 5 2 - 5  
 3 - 6 3 - 6  
 10 - 9

Position:	1	2	3
SP	2 & 3	2	1 & 2, 4 & 5
DP	5 & 6	3	2, 4 & 5
A	(ON)	NONE	OFF
B	(ON)	NONE	OFF
C	(ON)	NONE	OFF
D	(ON)	NONE	OFF
E	(ON)	NONE	OFF
F	(ON)	NONE	OFF
G	(ON)	NONE	OFF
H	(ON)	NONE	OFF
I	(ON)	NONE	OFF
J	(ON)	NONE	OFF
K	(ON)	NONE	OFF
L	(ON)	NONE	OFF
M	(ON)	NONE	OFF
N	(ON)	NONE	OFF
O	(ON)	NONE	OFF
P	(ON)	NONE	OFF
Q	(ON)	NONE	OFF
R	(ON)	NONE	OFF
S	(ON)	NONE	OFF
T	(ON)	NONE	OFF
U	(ON)	NONE	OFF
V	(ON)	NONE	OFF
W	(ON)	NONE	OFF
X	(ON)	NONE	OFF
Y	(ON)	NONE	OFF
Z	(ON)	NONE	OFF
AA	(ON)	NONE	OFF
AB	(ON)	NONE	OFF
AC	(ON)	NONE	OFF
AD	(ON)	NONE	OFF
AE	(ON)	NONE	OFF
AF	(ON)	NONE	OFF
AG	(ON)	NONE	OFF
AH	(ON)	NONE	OFF
AI	(ON)	NONE	OFF
AJ	(ON)	NONE	OFF
AK	(ON)	NONE	OFF
AL	(ON)	NONE	OFF
AM	(ON)	NONE	OFF
AN	(ON)	NONE	OFF
AO	(ON)	NONE	OFF
AP	(ON)	NONE	OFF
AQ	(ON)	NONE	OFF
AR	(ON)	NONE	OFF
AS	(ON)	NONE	OFF
AT	(ON)	NONE	OFF
AU	(ON)	NONE	OFF
AV	(ON)	NONE	OFF
AW	(ON)	NONE	OFF
AX	(ON)	NONE	OFF
AY	(ON)	NONE	OFF
AZ	(ON)	NONE	OFF
BA	(ON)	NONE	OFF
BB	(ON)	NONE	OFF
BC	(ON)	NONE	OFF
BD	(ON)	NONE	OFF
BE	(ON)	NONE	OFF
BF	(ON)	NONE	OFF
BG	(ON)	NONE	OFF
BH	(ON)	NONE	OFF
BI	(ON)	NONE	OFF
BJ	(ON)	NONE	OFF
BK	(ON)	NONE	OFF
BL	(ON)	NONE	OFF
BM	(ON)	NONE	OFF
BN	(ON)	NONE	OFF
BO	(ON)	NONE	OFF
BP	(ON)	NONE	OFF
BQ	(ON)	NONE	OFF
BR	(ON)	NONE	OFF
BS	(ON)	NONE	OFF
BT	(ON)	NONE	OFF
BU	(ON)	NONE	OFF
BV	(ON)	NONE	OFF
BW	(ON)	NONE	OFF
BX	(ON)	NONE	OFF
BY	(ON)	NONE	OFF
BZ	(ON)	NONE	OFF
CA	(ON)	NONE	OFF
CB	(ON)	NONE	OFF
CC	(ON)	NONE	OFF
CD	(ON)	NONE	OFF
CE	(ON)	NONE	OFF
CF	(ON)	NONE	OFF
CG	(ON)	NONE	OFF
CH	(ON)	NONE	OFF
CI	(ON)	NONE	OFF
CJ	(ON)	NONE	OFF
CK	(ON)	NONE	OFF
CL	(ON)	NONE	OFF
CM	(ON)	NONE	OFF
CN	(ON)	NONE	OFF
CO	(ON)	NONE	OFF
CP	(ON)	NONE	OFF
CQ	(ON)	NONE	OFF
CR	(ON)	NONE	OFF
CS	(ON)	NONE	OFF
CT	(ON)	NONE	OFF
CU	(ON)	NONE	OFF
CV	(ON)	NONE	OFF
CW	(ON)	NONE	OFF
CX	(ON)	NONE	OFF
CY	(ON)	NONE	OFF
CZ	(ON)	NONE	OFF
DA	(ON)	NONE	OFF
DB	(ON)	NONE	OFF
DC	(ON)	NONE	OFF
DD	(ON)	NONE	OFF
DE	(ON)	NONE	OFF
DF	(ON)	NONE	OFF
DG	(ON)	NONE	OFF
DH	(ON)	NONE	OFF
DI	(ON)	NONE	OFF
DJ	(ON)	NONE	OFF
DK	(ON)	NONE	OFF
DL	(ON)	NONE	OFF
DM	(ON)	NONE	OFF
DN	(ON)	NONE	OFF
DO	(ON)	NONE	OFF
DP	(ON)	NONE	OFF
DQ	(ON)	NONE	OFF
DR	(ON)	NONE	OFF
DS	(ON)	NONE	OFF
DT	(ON)	NONE	OFF
DU	(ON)	NONE	OFF
DV	(ON)	NONE	OFF
DW	(ON)	NONE	OFF
DX	(ON)	NONE	OFF
DY	(ON)	NONE	OFF
DZ	(ON)	NONE	OFF
EA	(ON)	NONE	OFF
EB	(ON)	NONE	OFF
EC	(ON)	NONE	OFF
ED	(ON)	NONE	OFF
EE	(ON)	NONE	OFF
EF	(ON)	NONE	OFF
EG	(ON)	NONE	OFF
EH	(ON)	NONE	OFF
EI	(ON)	NONE	OFF
EJ	(ON)	NONE	OFF
EK	(ON)	NONE	OFF
EL	(ON)	NONE	OFF
EM	(ON)	NONE	OFF
EN	(ON)	NONE	OFF
EO	(ON)	NONE	OFF
EP	(ON)	NONE	OFF
EQ	(ON)	NONE	OFF
ER	(ON)	NONE	OFF
ES	(ON)	NONE	OFF
ET	(ON)	NONE	OFF
EU	(ON)	NONE	OFF
EV	(ON)	NONE	OFF
EW	(ON)	NONE	OFF
EX	(ON)	NONE	OFF
EY	(ON)	NONE	OFF
EZ	(ON)	NONE	OFF
FA	(ON)	NONE	OFF
FB	(ON)	NONE	OFF
FC	(ON)	NONE	OFF
FD	(ON)	NONE	OFF
FE	(ON)	NONE	OFF
FG	(ON)	NONE	OFF
FH	(ON)	NONE	OFF
FI	(ON)	NONE	OFF
FJ	(ON)	NONE	OFF
FK	(ON)	NONE	OFF
FL	(ON)	NONE	OFF
FM	(ON)	NONE	OFF
FN	(ON)	NONE	OFF
FO	(ON)	NONE	OFF
FP	(ON)	NONE	OFF
FQ	(ON)	NONE	OFF
FR	(ON)	NONE	OFF
FS	(ON)	NONE	OFF
FT	(ON)	NONE	OFF
FU	(ON)	NONE	OFF
FV	(ON)	NONE	OFF
FW	(ON)	NONE	OFF
FX	(ON)	NONE	OFF
FY	(ON)	NONE	OFF
FZ	(ON)	NONE	OFF
GA	(ON)	NONE	OFF
GB	(ON)	NONE	OFF
GC	(ON)	NONE	OFF
GD	(ON)	NONE	OFF
GE	(ON)	NONE	OFF
GF	(ON)	NONE	OFF
GG	(ON)	NONE	OFF
GH	(ON)	NONE	OFF
GI	(ON)	NONE	OFF
GJ	(ON)	NONE	OFF
GK	(ON)	NONE	OFF
GL	(ON)	NONE	OFF
GM	(ON)	NONE	OFF
GN	(ON)	NONE	OFF
GO	(ON)	NONE	OFF
GP	(ON)	NONE	OFF
GQ	(ON)	NONE	OFF
GR	(ON)	NONE	OFF
GS	(ON)	NONE	OFF
GT	(ON)	NONE	OFF
GU	(ON)	NONE	OFF
GV	(ON)	NONE	OFF
GW	(ON)	NONE	OFF
GX	(ON)	NONE	OFF
GY	(ON)	NONE	OFF
GZ	(ON)	NONE	OFF
HA	(ON)	NONE	OFF
HB	(ON)	NONE	OFF
HC	(ON)	NONE	OFF
HD	(ON)	NONE	OFF
HE	(ON)	NONE	OFF
HF	(ON)	NONE	OFF
HG	(ON)	NONE	OFF
HH	(ON)	NONE	OFF
HI	(ON)	NONE	OFF
HJ	(ON)	NONE	OFF
HK	(ON)	NONE	OFF
HL	(ON)	NONE	OFF
HM	(ON)	NONE	OFF
HN	(ON)	NONE	OFF
HO	(ON)	NONE	OFF
HP	(ON)	NONE	OFF
HQ	(ON)	NONE	OFF
HR	(ON)	NONE	OFF
HS	(ON)	NONE	OFF
HT	(ON)	NONE	OFF
HU	(ON)	NONE	OFF
HV	(ON)	NONE	OFF
HW	(ON)	NONE	OFF
HX	(ON)	NONE	OFF
HY	(ON)	NONE	OFF
HZ	(ON)	NONE	OFF
IA	(ON)	NONE	OFF
IB	(ON)	NONE	OFF
IC	(ON)	NONE	OFF
ID	(ON)	NONE	OFF
IE	(ON)	NONE	OFF
IF	(ON)	NONE	OFF
IG	(ON)	NONE	OFF
IH	(ON)	NONE	OFF
II	(ON)	NONE	OFF
IJ	(ON)	NONE	OFF
IK	(ON)	NONE	OFF
IL	(ON)	NONE	OFF
IM	(ON)	NONE	OFF
IN	(ON)	NONE	OFF
IO	(ON)	NONE	OFF
IP	(ON)	NONE	OFF
IQ	(ON)	NONE	OFF
IR	(ON)	NONE	OFF
IS	(ON)	NONE	OFF
IT	(ON)	NONE	OFF
IU	(ON)	NONE	OFF
IV	(ON)	NONE	OFF
IW	(ON)	NONE	OFF
IX	(ON)	NONE	OFF
IY	(ON)	NONE	OFF
IZ	(ON)	NONE	OFF
JA	(ON)	NONE	OFF
JB	(ON)	NONE	OFF
JC	(ON)	NONE	OFF
JD	(ON)	NONE	OFF
JE	(ON)	NONE	OFF
JF	(ON)	NONE	OFF
JG	(ON)	NONE	OFF
JH	(ON)	NONE	OFF
JI	(ON)	NONE	OFF
JJ	(ON)	NONE	OFF
JK	(ON)	NONE	OFF
JL	(ON)	NONE	OFF
JM	(ON)	NONE	OFF
JN	(ON)	NONE	OFF
JO	(ON)	NONE	OFF
JP	(ON)	NONE	OFF
JQ	(ON)	NONE	OFF
JR	(ON)	NONE	OFF
JS	(ON)	NONE	OFF
JT	(ON)	NONE	OFF
JU	(ON)	NONE	OFF
JV	(ON)	NONE	OFF
JW	(ON)	NONE	OFF
JX	(ON)	NONE	OFF
JY	(ON)	NONE	OFF
JZ	(ON)	NONE	OFF
KA	(ON)	NONE	OFF
KB	(ON)	NONE	OFF
KC	(ON)	NONE	OFF
KD	(ON)	NONE	OFF
KE	(ON)	NONE	OFF
KF	(ON)	NONE	OFF
KG	(ON)	NONE	OFF
KH	(ON)	NONE	OFF
KI	(ON)	NONE	OFF
KJ	(ON)	NONE	OFF
KK	(ON)	NONE	OFF
KL	(ON)	NONE	OFF
KM	(ON)	NONE	OFF
KN	(ON)	NONE	OFF
KO	(ON)	NONE	OFF
KP	(ON)	NONE	OFF
KQ	(ON)	NONE	OFF
KR	(ON)	NONE	OFF
KS	(ON)	NONE	OFF
KT	(ON)	NONE	OFF
KU	(ON)	NONE	OFF
KV	(ON)	NONE	OFF
KW	(ON)	NONE	OFF
KX	(ON)	NONE	OFF
KY	(ON)	NONE	OFF
KZ	(ON)	NONE	OFF
LA	(ON)	NONE	OFF
LB	(ON)	NONE	OFF
LC	(ON)	NONE	OFF
LD	(ON)	NONE	OFF
LE	(ON)	NONE	OFF
LF	(ON)	NONE	OFF
LG	(ON)	NONE	OFF
LH	(ON)	NONE	OFF
LI	(ON)	NONE	OFF
LJ	(ON)	NONE	OFF
LK	(ON)	NONE	OFF
LL	(ON)	NONE	OFF
LM	(ON)	NONE	OFF
LN	(ON)	NONE	OFF
LO	(ON)	NONE	OFF
LP	(ON)	NONE	OFF
LQ	(ON)	NONE	OFF
LR	(ON)	NONE	OFF
LS	(ON)	NONE	OFF
LT	(ON)	NONE	OFF
LU	(ON)	NONE	OFF

# Ordering Scheme

Contura X locking

Sample Part Number

V 1 D A S W 0 1 - 1 P B 00 - 0

Selection 1 2 3 4 5 6 7 8 9 10 11 12 13

## 1. SERIES

V V-Series

## 2. CIRCUIT

Terminal Connections as viewed ( ) - momentary from bottom of switch: SP - single pole: terminals 1, 2 & 3.  
**8 terminal** **10 terminal** DP - double pole: terminals 1, 2, 3, 4, 5 & 6.  
 8 - - 7 8 - - 7 Terminals 7, 8, 9 & 10 for lamp circuit only.  
 1 - - 4 1 - - 4  
 2 - - 5 2 - - 5  
 3 - - 6 3 - - 6  
 10 - - 9

Position:	1	2	3
SP DP	2 & 3, 5 & 6	Connected Terminals	1 & 2, 4 & 5
1 A	ON	NONE	OFF
4 D	ON	NONE	ON
6 J	ON	OFF	ON
9 N	OFF	NONE	ON

SPECIAL CIRCUITS	2 & 3	2 & 3, 5 & 4	5 & 4
H*	2 & 3	2 & 3	OFF
G*	2 & 3, 5 & 6	2 & 3	1 & 2
S*	2 & 3, 5 & 6	2 & 3	5 & 1
E*	5 & 6	5 & 3	

\*Jumper between terminals 2 & 5 for circuits H,G,M,R & S are specified in selection 4. External jumper between terminals 2 & 4 for circuit E are provided by customer. Circuit E may be used for SP OFF-ON-ON circuit.

## 3. RATING 4

1	.4VA @ 28VDC Resistive
5	10A 250VAC 1/2 HP, 15A 125 VAC 1/2 HP, UL Recog., CSA Certified
B	15A 24V
C	20A 18V
D	20A 12V
E	20A 14V, 10A 14VT (circuit 1, 4, A & D only)
F	10A 14V, 6A 14VT (circuit G only)

## 4. TERMINATION / BASE STYLE

8 term	10 Term	Termination	Jumper
1	2	.250 TAB (QC) no barriers	No
A	B	.250 TAB (QC) with barriers	No
J	K	.250 TAB (QC) no barriers	Yes T2 to 5
3	4	Solder Lug no barriers	No
C	D	Solder Lug	No
5	6	Wire Leads no barriers	No
E	F	Wire Leads	No

Note: Codes J & K for circuits H, G & M. Do not use silicone based lubricants to reduce terminal insertion forces during connector assembly, as it is detrimental to function and performance.

## 5. ILLUMINATION & SWITCH SEALING

Lamp #1: above terminals 1 & 4 end of switch; Lamp #2 above terminals 3 & 6 end of switch. Positive (+) and negative (-) symbols apply to LED lamps only

Sealed	Lamps	illumination Type	Lamp wired to Terminals
S	NONE	-	-
C	2	UP	3 (+) 7 (-)
H	2	INDEPENDENT	8 (+) 7 (-)
DOUBLE POLE SWITCHES ONLY			
M	1	UP	3 (+) 6 (-)

## 6. LOCKS

Lock above terminals 1 & 4 end of switch.  
**W** Lock

Notes: Consult factory to verify horsepower rating for your particular circuit choice.

- 1 Custom colors are available. Consult factory.
- 2 White imprinting is standard on black actuators; Black imprinting is standard on white, red and gray actuators; Custom colors are available, consult factory.
- 3 Located over T1-4 end of switch.
- 4 Additional ratings available. See V-Series Switch Accessories page.
- 5 Located over T3-6 end of switch.

## 6.7. LAMP (SAME CODING FOR BOTH SELECTIONS)

Selection 6: above terminals 1 & 4; Selection 7: above terminals 3 & 6  
 No lamp **0**  
 Neon 1 125VAC 2 250VAC

LED*	Red	Amber	superbright Green	superbright Red
2VDC	A	L	F	R
12VDC	C	N	H	T
24VDC	D	P	J	V

\* Consult factory for "daylight bright" LED options. Typical current draw for LED is 20ma.

## 8. FLUSH BRACKET COLOR, PANEL SEAL 1

No Gasket	1	Black
One Gasket	4	

## 9. HARD SURFACE ACTUATOR

Contura X	Black	Red
	1	4

Actuator orientation over terminals:



3,6 1,4

## 10. LENS - ABOVE LAMP #2 TERMINALS 5

Z - No Lens	Clear	White	Amber	Green	Red	Blue	Lens Style
3	8	D	J	P	V		Bar
4	9	E	K	R	W		One piece Square
5	A	F	L	S	Y		Two piece Square* (with clear top protective lens)

\* All bottom lenses are molded of opaque material. Consult factory for other lens colors. Lens color for LEDs must be clear, white, or match color of LED. Green or blue lenses are not recommended with Neon lamps.

## 12. ACTUATOR LOCK FUNCTION 3

Lock Color	Up	Down	Up & Down
Match Actuator	A	H	R
Black	B	J	S
White	C	K	T
Red	D	L	V
Safety Orange	E	M	W
Gray	F	G	N

## 13. ACTUATOR LENS OR BODY LEGENDS 2

00 - No Legend	21	22	23	24
	OFF	ON	O	I
25	O	26 O	27 O	28 I
	F	N		



For additional legend options & codes, visit us at [www.carlingtech.com](http://www.carlingtech.com)

## 14. LEGEND ORIENTATION 3

0	No legend (used with codes 11-18 in selection 12)
1	Orientation 1
2	Orientation 2
3	Orientation 3
4	Orientation 4

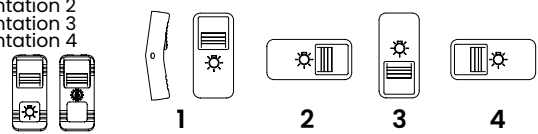

[Configure Complete Part Number >](#)

[Browse Standard Parts >](#)

# Ordering Scheme

Contura XIV

Sample Part Number

V 1 D B B C 0 B-FA P C AB- 1 00

Selection 1 2 3 4 5 6 7 8 9 10 11 12 13 14

## 1. SERIES

V V-Series

## 2. CIRCUIT

Terminal Connections as viewed ( ) - momentary from bottom of switch: SP - single pole: terminals 1, 2 & 3.  
 8 terminal 10 terminal DP - double pole: terminals 1, 2, 3, 4, 5 & 6.  
 8 -- 7 8 -- 7 Terminals 7, 8, 9 & 10 for lamp circuit only.  
 1 -- 4 1 -- 4  
 2 -- 5 2 -- 5  
 3 -- 6 3 -- 6  
 10 -- 9

Position:	1	2	3
SP	2 & 3, 5 & 6	Connected Terminals	1 & 2, 4 & 5
1 A	ON	NONE	OFF
2 B	(ON)	NONE	OFF
3 C	ON	NONE	(OFF)
4 D	ON	NONE	ON
5 F	ON	NONE	(ON)
6 J	ON	OFF	ON
7 K	ON	OFF	(ON)
8 L	(ON)	OFF	(ON)

SPECIAL CIRCUITS	1	2	3
H*	2 & 3	2 & 3, 5 & 4	5 & 4
G*	2 & 3, 5 & 6	2 & 3	OFF
M*	(2 & 3, 5 & 6)	2 & 3	OFF
R*	(2 & 3, 5 & 6)	2 & 3	2 & 1
E*	5 & 6	5 & 3	5 & 1
S*	2 & 3, 5 & 6	2 & 3	1 & 2

\*Jumper between terminals 2 & 5 for circuits H,G,M,R & S are specified in selection 4. External jumper between terminals 2 & 4 for circuit E are provided by customer. Circuit E may be used for SP OFF-ON-ON circuit.

## 3. RATING 3

1	.4VA @ 28VDC Resistive
5	10A 250VAC 1/2 HP, 15A 125 VAC 1/2 HP, UL Recog., CSA Certified
B	15A 24V
C	20A 18V
D	20A 12V
E	20A 14V, 10A 14VT (circuit 1, 4, A & D only)
F	10A 14V, 6A 14VT (circuit G only)

## 4. TERMINATION / BASE STYLE

8 Term	10 Term	Termination	Jumper
1	2	.250 TAB (QC) no barriers	No
A	B	.250 TAB (QC) with barriers	No
J	K	.250 TAB (QC) no barriers	Yes T2 to 5
3	4	Solder Lug no barriers	No
C	D	Solder Lug	No
5	6	Wire Leads no barriers	No
E	F	Wire Leads	No

Note: Codes J & K for circuits H, G & M. Do not use silicone based lubricants to reduce terminal insertion forces during connector assembly, as it is detrimental to function and performance.

## 5. ILLUMINATION & SWITCH SEALING

Lamp #1: above terminals 1 & 4 end of switch.; Lamp #2 above terminals 3 & 6 end of switch. Positive (+) and negative (-) symbols apply to LED lamps only

Lamps	illumination Type	Lamp wired to Terminals
S	NONE	-
A	INDEPENDENT	8 (+) 7 (-)
B	DOWN	3 (+) 7 (-)
C	UP	3 (+) 7 (-)
D	DOWN	3 (+) 7 (-)
E	DOWN	1 (+) 7 (-)
F	UP	1 (+) 7 (-)
G	UP	3 (+) 7 (-)
H	INDEPENDENT	8 (+) 7 (-)
I	UP	3 (+) 7 (-)
J	INDEPENDENT	8 (+) 7 (-)
K	INDEPENDENT	8 (+) 7 (-)
L	DOWN	3 (+) 6 (-)
M	UP	3 (+) 6 (-)
N	DOWN	3 (+) 6 (-)
P	UP	1 (+) 4 (-)
U	INDEPENDENT	8 (+) 7 (-)
	INDEPENDENT	10 (+) 9 (-)

## 6 & 7. LAMP

No lamp	0	1 125VAC	2 250VAC
LED*	Red	Amber	superbright Green
2VDC	A	L	F
12VDC	C	N	H
24VDC	D	P	J
			superbright Red
			R
			T
			V

\* Consult factory for "daylight bright" LED options. Typical current draw for LED is 20ma.

## 8. BRACKET COLOR & PANEL SEAL

Color	No Gasket	1 Gasket	2 Gasket
Black	B	C	D

## 9. ACTUATOR STYLE

0	No Actuator - Furnished separately
FA	Contura XIV
FB	Contura XIV - Laser Etched



## 10. LENS COLOR / STYLE

0 - No Actuator	Z - No Lens				
Clear	White	Amber	Green	Red	Blue
1	6	B	G	M	T
2	7	C	H	N	U
3	8	D	J	P	V
4	9	E	K	R	W
5	A	F	L	S	Y
	A	N/A	N/A	N/A	N/A

Laser-Etched Actuator

Only Lens color for LEDs must be clear, white, or match color of LED. Green or blue lenses are not recommended with Neon lamps.

## 11. ACTUATOR COLOR 1

0	N/A - No Actuator
C	Black
S	Red

## 12. ACTUATOR LENS OR BODY LEGEND 2

00 - No Legend this location / No actuator

11	ON	12 OFF	13 I	14 O
	OFF	ON	O	I
15	O O	16 O O	17 O I	18 I O
	F N	N F		
	F	F		



## 12. ACTUATOR LENS OR BODY LEGEND

0	No legend
1	Orientation 1
2	Orientation 2
3	Orientation 3
4	Orientation 4



## 12. ACTUATOR LENS OR BODY LEGEND

00 No legend this location / no actuator

(used with codes 11-18 in selection 12) Selection 14 required when switch requires two legends. If the two legends consist of one lens and one body legend, lens legend must be specified in selection 12; body legend specified in selection 14.

For legend options & codes, visit us at [www.carlingtech.com](http://www.carlingtech.com).

Notes: Consult factory to verify horsepower rating for your particular circuit choice.

- 1 Custom colors are available. Consult factory.
- 2 White imprinting is standard on black actuators; Black imprinting is standard on white, red and gray actuators.
- 3 Additional ratings available. See V-Series Switch Accessories page.

Configure Complete Part Number >

Browse Standard Parts >

# Ordering Scheme

Contura XIV Locking

Sample Part Number

V 1 D A B W 0 B-FC Z B 00-0

Selection 1 2 3 4 5 6 7 8 9 10 11 12 13

## 1. SERIES

V V-Series

## 2. CIRCUIT

Terminal Connections as viewed ( ) - momentary from bottom of switch: SP - single pole; terminals 1, 2 & 3.  
**8 terminal** **10 terminal** DP - double pole; terminals 1, 2, 3, 4, 5 & 6.  
 8 -- 7 8 -- 7 Terminals 7, 8, 9 & 10 for lamp circuit only.  
 1 - 4 1 - 4  
 2 - 5 2 - 5  
 3 - 6 3 - 6  
 10 -- 9

Position:	1	2	3
SP DP	2 & 3, 5 & 6	Connected Terminals	1 & 2, 4 & 5
1 A	ON	NONE	OFF
- B	(ON)	NONE	OFF
4 D	ON	NONE	ON
6 J	ON	OFF	ON
7 K	(ON)	OFF	(ON)
8 L	(ON)	OFF	(ON)
9 N	OFF	NONE	ON

### SPECIAL CIRCUITS

H*	2 & 3	2 & 3, 5 & 4	5 & 4
G*	2 & 3, 5 & 6	2 & 3	OFF
M*	(2 & 3, 5 & 6)	2 & 3	OFF
R*	(2 & 3, 5 & 6)	2 & 3	2 & 1
E*	5 & 6	5 & 3	5 & 1
S*	2 & 3, 5 & 6	2 & 3	1 & 2

\*Jumper between terminals 2 & 5 for circuits H,G,M,R & S are specified in selection 4. External jumper between terminals 2 & 4 for circuit E are provided by customer. Circuit E may be used for SP OFF-ON-ON circuit.

## 3. RATING

3

1	.4VA @ 28VDC Resistive
5	10A 250VAC 1/2 HP, 15A 125 VAC 1/2 HP, UL Recog., CSA Certified
B	15A 24V
C	20A 18V
D	20A 12V
E	20A 14V, 10A 14VT (circuit 1, 4, A & D only)
F	10A 14V, 6A 14VT (circuit G only)

## 4. TERMINATION / BASE STYLE

8 Term	10 Term	Termination	Jumper
1	2	.250 TAB (QC) no barriers	No
A	B	.250 TAB (QC) with barriers	No
J	K	.250 TAB (QC) no barriers	Yes T2 to 5

Note: Codes J & K for circuits H, G & M. Do not use silicone based lubricants to reduce terminal insertion forces during connector assembly, as it is detrimental to function and performance.

## 5. ILLUMINATION & SWITCH SEALING

Lamp #1: above terminals 1 & 4 end of switch.; Lamp #2 above terminals 3 & 6 end of switch. Positive (+) and negative (-) symbols apply to LED lamps only

Lamps	illumination Type	Lamp wired to Terminals
S	NONE	-
C	2 UP	3 (+) 7 (-)
H	2 INDEPENDENT	8 (+) 7 (-)

### DOUBLE POLE SWITCHES ONLY

M	1 UP	3 (+) 6 (-)
---	------	-------------

## 5. LOCK OPTION

W Low Profile Lock

Notes: Consult factory to verify horsepower rating for your particular circuit choice.

- Custom colors are available. Consult factory.
- White imprinting is standard on black actuators; Black imprinting is standard on white, red and gray actuators.
- Additional ratings available. See V-Series Switch Accessories page.

## 7. LAMP

No lamp	0		
Neon	1	125VAC	2 250VAC
LED*			superbright superbright
	Red	Amber	Green Red
2VDC	A	L	F R
12VDC	C	N	H T
24VDC	D	P	J V

\* Consult factory for "daylight bright" LED options. Typical current draw for LED is 20ma.

## 8. BRACKET COLOR & PANEL SEAL

Color	No Gasket	1 Gasket	2 Gasket
Black	B	C	D

## 9. ACTUATOR COLOR / STYLE

FC	Black - Standard Rocker
FD	Black - Laser Etched
FS	Red - Standard Rocker
FT	Red - Laser Etched



## 10. LENS COLOR / STYLE

Z	No Lens				
Clear	White	Amber	Green	Red	Blue
1	6	B	G	M	T
3	8	D	J	P	V
5	A	N/A	N/A	N/A	N/A

Legend: Laser-Etched Only

Lens color for LEDs must be clear, white, or match color of LED. Green or blue lenses are not recommended with Neon lamps.

## 11. ACTUATOR LOCK COLOR / FUNCTION

1

Lock Color	LOCK IN POSITION			
	UP	DOWN	UP & DOWN	CENTER
Match Actuator	A	H	R	1
Black	B	J	S	2
White	C	K	T	3
Red	D	L	V	4
Orange	E	M	W	5
Gray	F	G	N	6

## 12. ACTUATOR LENS OR BODY LEGENDS

2

00	No Legend		
21	OFF	22 ON	23 O
			24 I
25 O	26 O	27 O	28 I
F	N		
F			



## 13. LEGEND ORIENTATION

0	No legend
1	Orientation 1
2	Orientation 2
3	Orientation 3
4	Orientation 4

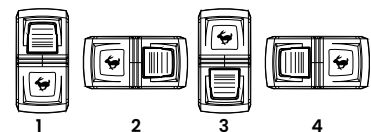

[Configure Complete Part Number >](#)

[Browse Standard Parts >](#)

# Dimensional Specs

inches [millimeters]

## CONTURA II

SHOWN WITH  
SQUARE LENS

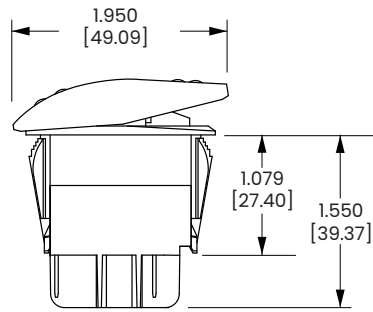
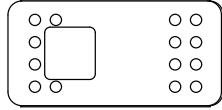

**8 TERMINAL BASE  
W/BARRIERS**

## CONTURA III

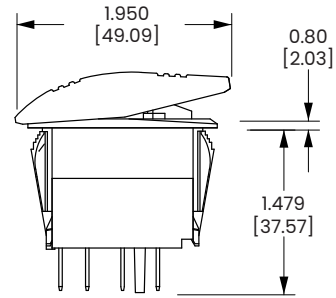
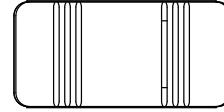

**8 TERMINAL BASE  
W/O BARRIERS**

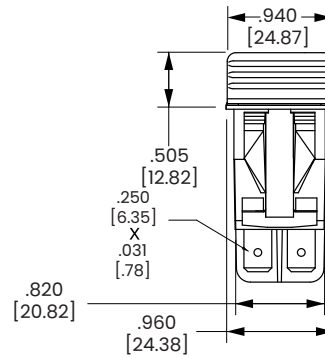
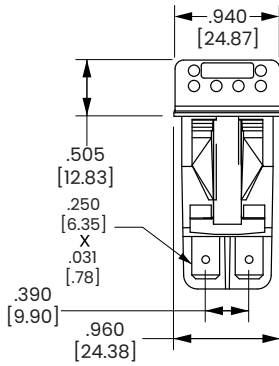

**10 TERMINAL BASE  
W/BARRIERS**

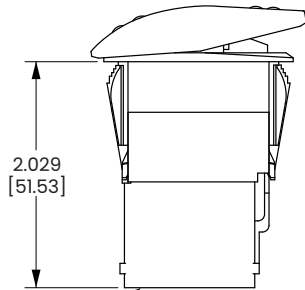

**SWITCH SHOWN WITH  
VCH CONNECTOR 8  
TERMINAL**

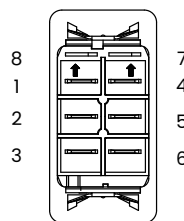

**BOTTOM VIEW  
TERMINAL  
ARRANGEMENT  
8 TERMINAL BASE**

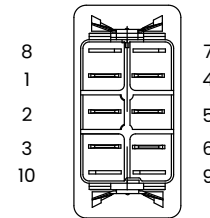

**BOTTOM VIEW  
TERMINAL  
ARRANGEMENT  
10 TERMINAL BASE**

# Dimensional Specs

inches [millimeters]

## CONTURA IV

SHOWN WITH  
BAR LENS

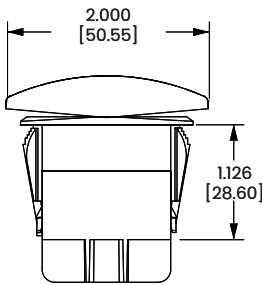
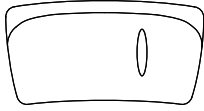

10 TERMINAL BASE  
W/BARRIERS

## CONTURA V

SHOWN WITH  
BAR LENS

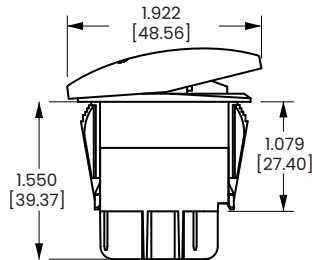
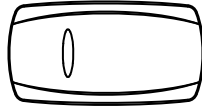

8 TERMINAL BASE  
W/BARRIERS

## CONTURA V

SHOWN WITH  
LOW PROFILE LOCK

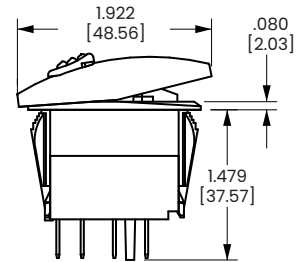
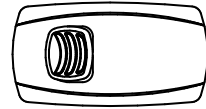

8 TERMINAL BASE  
W/O BARRIERS

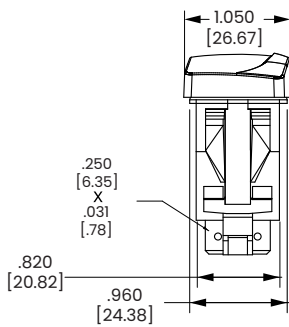

10 TERMINAL BASE  
W/O BARRIERS

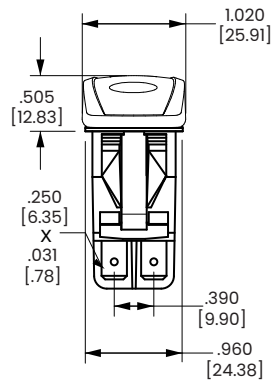

8 TERMINAL BASE  
W/BARRIERS

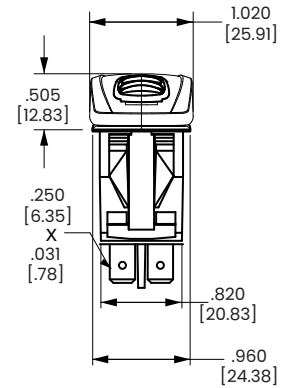

8 TERMINAL BASE  
W/O BARRIERS

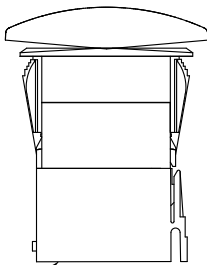

SWITCH SHOWN WITH  
VCI CONNECTOR 10  
TERMINAL

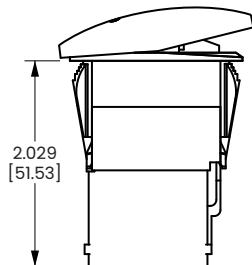

SWITCH SHOWN WITH  
VCH CONNECTOR 8  
TERMINAL

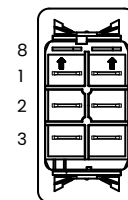

BOTTOM VIEW  
TERMINAL  
ARRANGEMENT  
8 TERMINAL BASE

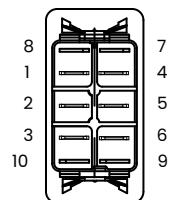

BOTTOM VIEW  
TERMINAL  
ARRANGEMENT  
10 TERMINAL BASE

# Dimensional Specs

inches [millimeters]

**CONTURA X**  
SHOWN WITH RAISED BRACKET

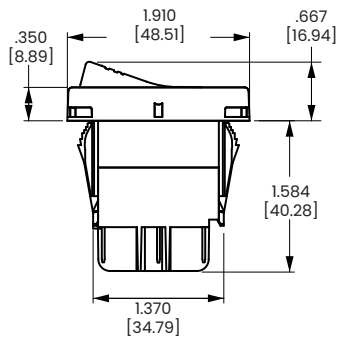
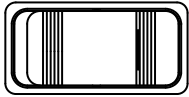

**8 TERMINAL BASE  
W/BARRIERS**

**CONTURA XI**  
SHOWN WITH RAISED  
BRACKET AND TWO SQUARE  
LENSES

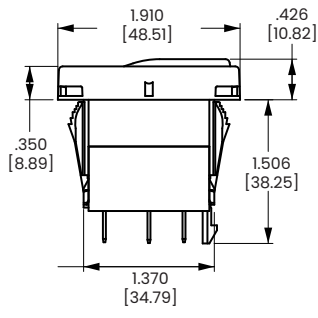
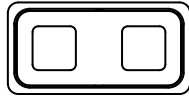

**10 TERMINAL BASE  
W/O BARRIERS**

**CONTURA XII**  
SHOWN WITH PADDLE  
ACTUATOR

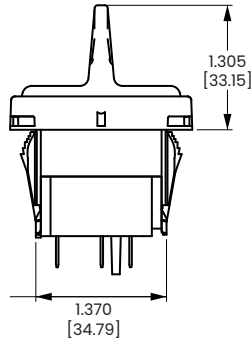
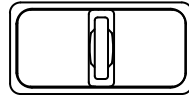

**8 TERMINAL BASE  
W/O BARRIERS**

**CONTURA XIV**  
SHOWN WITH LARGE LENS

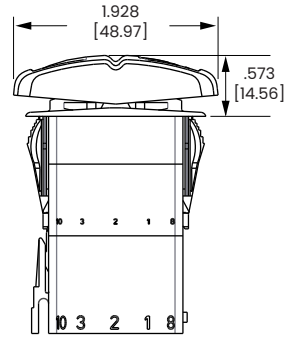
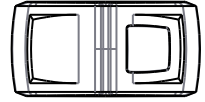

**10 TERMINAL BASE  
W/O BARRIERS**

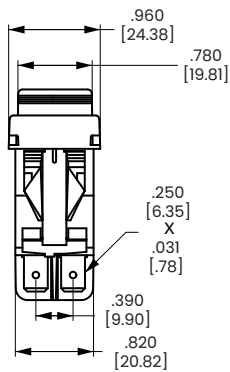

**8 TERMINAL BASE  
W/BARRIERS**

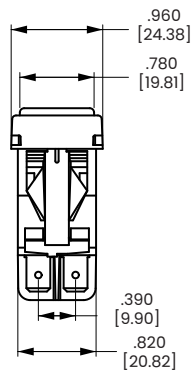

**10 TERMINAL BASE  
W/O BARRIERS**

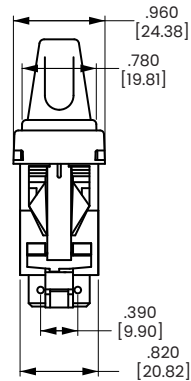

**10 TERMINAL BASE  
W/O BARRIERS**

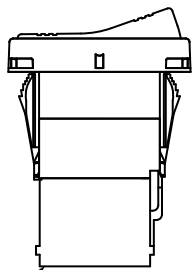
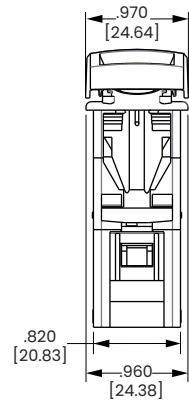

SWITCH SHOWN WITH  
VCH CONNECTOR  
8 TERMINAL

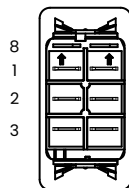

**BOTTOM WITH TERMINAL  
ARRANGEMENT  
8 TERMINAL BASE**

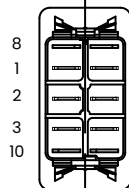

**BOTTOM WITH TERMINAL  
ARRANGEMENT  
10 TERMINAL BASE**

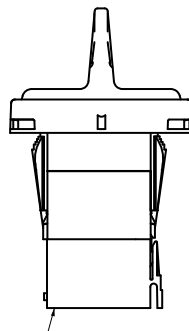

SWITCHES SHOWN WITH  
VCI CONNECTOR  
10 TERMINAL

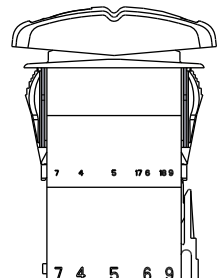

# Circuit Diagrams:

CIRCUIT CODE	CIRCUIT DIAGRAM
1	
2	
3	
4	
5	
6	
7	
8	

CIRCUIT CODE	CIRCUIT DIAGRAM
A	
B	
C	
D	
E	
F	
G	
H	

CIRCUIT CODE	CIRCUIT DIAGRAM
J	
K	
L	
M	
R	
S	

SYMBOL LEGEND	
SYM.	DEFINITION
○	DESIGNATES TERMINALS AND CONTACTS
—○	DESIGNATES MAINTAINED CIRCUITS
- -	DESIGNATES OTHER POSITION
—○	DESIGNATES MOMENTARY CIRCUITS
—○—	DESIGNATES TWO POSITION CONNECTION
—	DESIGNATES EXTERNAL JUMPER PROVIDED BY CUSTOMER

# Lamp Circuit Diagrams:

LAMP CIRCUIT CODE	CIRCUIT DIAGRAM	LAMP CIRCUIT CODE	CIRCUIT DIAGRAM	LAMP CIRCUIT CODE	CIRCUIT DIAGRAM	LAMP CIRCUIT CODE	CIRCUIT DIAGRAM
A		F		L		SPECIAL #1	
B		G		M		SPECIAL #3	
C		H		N		SPECIAL #4	
D		J		P			
E		K		U			

## J-Series Hazard Warning Circuit Diagrams:

CIRCUIT CODE	CIRCUIT DIAGRAM	CIRCUIT CODE	CIRCUIT DIAGRAM
J1		J5	
J2		JA	
J3		JJ	
J4		JK	

NOTE:  
J circuits are available for all non-locking V-Series styles. Consult factory for partnumber details.

SYMBOL LEGEND	
SYM.	DEFINITION
	DESIGNATES TERMINALS AND CONTACTS
	DESIGNATES LAMP LOCATION

# Stand-Alone Components

Reduce inventory levels and cost by stocking actuators and base switches separately.

**Contura II, III, IV, V, X, XI, XII, XIV Base switches separately:** specify V with code selections 2-8 in the ordering schemes.

**Contura II, III, IV, V Actuator only:** VV with code A or C for selection 9, & with selections 10-14 in the ordering schemes.

**Contura II, III, IV, V Actuator only:** VV with code A, C, E, G, P or Z for selection 9 & with selections 10-14 in the ordering schemes.

**Contura X, XI, XII, XIV actuators with lenses separately:** VV with code selections 9-14 in the ordering schemes.

Panel Seal: VPS

## Contura X & XI actuators without lenses separately

VVR 6 1 00 1

1 2 3 4 5

**1. CONTURA X & XI ACTUATOR SEPARATELY**  
VVR

**2. ACTUATOR STYLE & COLOR**

	Black	Gray	White	Red
Contura X	1	2	3	4
Contura XI	6	7	8	9

**3. LENS OPENING FOR 1**

1	One bar lens			
2	Two bar lenses			
3	One square lens	5	square lens on top/ bar lens on bottom (Contura X only)	
4	Two square lens			

**4. ACTUATOR LENS OR BODY LEGEND**

00 - No Legend this location

11	ON	12	OFF	13	I	14	O	
			OFF		ON		O	I
15	O	16	O	17	O	18	I	O
	F		N		F			

For additional legend options & code, visit us at [www.carlingtech.com](http://www.carlingtech.com)

**5. LEGEND ORIENTATION 1**

0	No legend				
1	Orientation 1				
2	Orientation 2				
3	Orientation 3				
4	Orientation 4				

## Contura X, XI & XII top piece of 2-piece lens separately

VVT 1

1 2

**1 TOP OF LENS SEPARATELY**  
VVT

**2 COLOR**

1 Clear

## Contura X, XI & XII actuator lens assembly:



1 piece lens/bar lens are positioned the same as bottom lens for assembly, minus the top lens. Lenses snap in from bottom.

- Notes:
- If actuator lens opening for 2 bar or 2 square lenses, legend orientation 0, 1, or 2 must be chosen.
  - Center of actuator marking not available for Contura XII.
  - Legend is not available for bar style lens.
  - Not recommended with neon lamps.
  - Must also order top piece of 2 piece square lens separately.

## Contura XII actuators without lenses separately

VVP J 1 Z 21 1 00

1 2 3 4 5 6 7

**1 CONTURA XII ACTUATOR SEPARATELY**  
VVP

**2. ACTUATOR STYLE & COLOR**

J Black K Gray N White M Red

**3,4 LENS OPENING FOR 1**

Z No lens 1 Bar lens 2 Square lens

**5, 7 LENS OR BODY LEGEND 2**

00	- No Legend	21	OFF	22	ON	23	O	24	I
		25	O	26	O	27	O	28	I
			F		N				

For additional legend options & codes, visit us at [www.carlingtech.com](http://www.carlingtech.com)

**6 LEGEND ORIENTATION 3**

0	No legend				
1	Orientation 1				
2	Orientation 2				

## Contura X, XI & XII actuator lens assembly separately

VVL 2 1 00 0

1 2 3 4 5

**1 CONTURA X, XI & XII LENS SEPARATELY**  
VVL

**2 LENS STYLE 3**

1 Bar lens  
2 One Piece Square lens  
3 Bottom of Two-Piece Square lens<sup>5</sup>

**3 TRANSLUCENT LENS COLOR**

1 Clear 2 White 3 Amber 4 Green<sup>4</sup> 5 Red 6 Blue<sup>4</sup>

**4 LENS OR BODY LEGEND 2**

00	- No Legend	21	OFF	22	ON	23	O	24	I
		25	O	26	O	27	O	28	I
			F		N				

For additional legend options & codes, visit us at [www.carlingtech.com](http://www.carlingtech.com).

**5 LEGEND ORIENTATION 3**

0	No legend				
1	Orientation 1				
2	Orientation 2				
3	Orientation 3				
4	Orientation 4				

# Accessories

Easily integrate Contura products into your system, with Contura Accessories

## Contura Connectors



Q.C. SELECTION GUIDE					
COMPANY SERIES	PART NO		WIRE RANGE		ORIENTATION
	PLAIN BRASS	TIN PLATED BRASS	AWG	MM <sup>2</sup> (REF)	
PACKARD 58 SERIES	02965580		12	3.0	B
	02965471	12010601	(2)16-14	(2)1.0-2.0	
	02965470		16-14	1.0-2.0	
	02965469	06288318	20-18	.5-.8	
PACKARD METRI-PACK 630 SERIES		12084590	105.0		A
		12052224	123.0		
		12015870	16-14	1.0-2.0	
		12020035	(2)22-18	(2).5-.8	
		12015869	20-18	.5-.8	
		12052222	20-22	.35-.5	
AMP 250 SERIES FASTIN-FASTON	60253-1	60253-2	16-12	1.3-3	B
	42100-1	42100-2	18-14	.8-2	
	60295-1	60295-2	22-18	.3-.9	

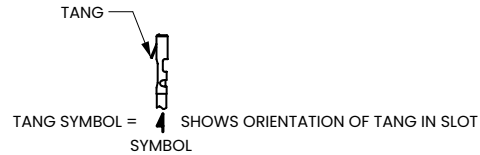

NOTE: Consult Delphi Packard and/or Amp on actual part numbers and availability. AMP is a registered trademark of AMP Inc. Harrisburg, PA. Delphi Packard is a registered trademark of Delphi-Packard Electrical Systems Warr

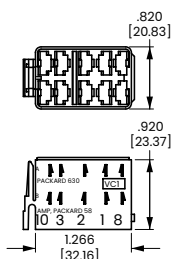

VC1  
CONNECTOR HOUSING

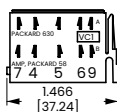

MARKING DETAIL  
REAR VIEW

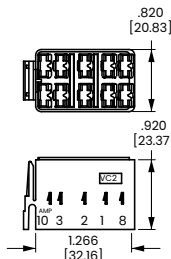

VC2  
CONNECTOR HOUSING  
(For AMP terminals only)

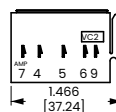

MARKING DETAIL  
REAR VIEW

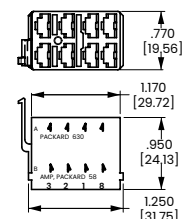

VCH  
CONNECTOR HOUSING

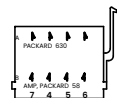

MARKING DETAIL  
REAR VIEW

## Contura X Boot (P/N VB1-01)

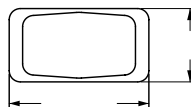

## Contura II, III, IV and V Actuator Removal Tool (P/N VRT)

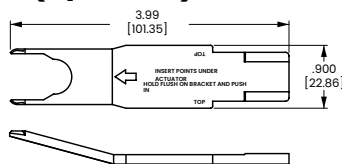

## Additional V-Series Ratings

- 1 .4VA @ 28VDC Resistive
- 4 10A 250VAC 1/2 HP, 15A 125 VAC 1/2 HP, No Agency Listings
- 5<sup>1</sup> 10A 250VAC 1/2 HP, 15A 125 VAC 1/2 HP, UL Recognized, CSA Certified
- B 15A 24V
- C 20A 18V
- D 20A 12V
- E 20A 14V, 10A 14VT (circuits 1, 4, A, & D only)
- F 10A 14V, 6A, 14VT (circuit G only)
- G 20A 6V
- H 20A 3V
- L<sup>2</sup> 15A 125 VAC, 10A 250VAC, 1/2 HP 125-250 VAC; 6A 125 VAC L

### NOTES

Consult factory to determine availability for individual circuits and their HP rating.

1. Not available with Contura 7 or 14 rocker styles.
2. Rating L available with circuits 1, 4, A & D only.

# Accessories

## Contura Mounting Panels Dimensional Specifications: in. [mm]

**MOUNTING PANEL**  
For additional units, add 1.03 [26.2] per unit. For more than 2 V-Series Switches, add middle section. Available in panel Thicknesses listed below. Consult factory.

MOUNTING PANEL THICKNESS	
.862	.887
[1.57]	[4.76]
.983	.290
[2.36]	[6.35]
.325	.375
[3.17]	[9.52]

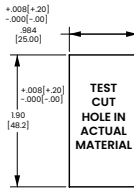

VMS MOUNTING PANEL HOLE

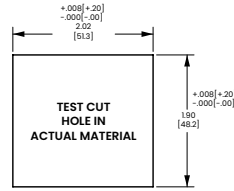

MOUNTING PANEL OPENING (2) UNITS

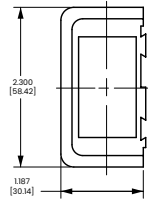

VME MOUNTING PANEL END

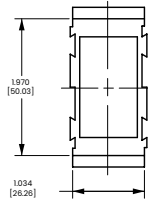

VMM MOUNTING PANEL MIDDLE

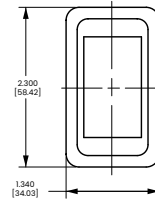

VMS MOUNTING PANEL

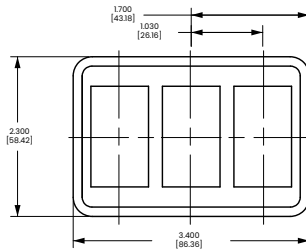

VM3 MOUNTING PANEL

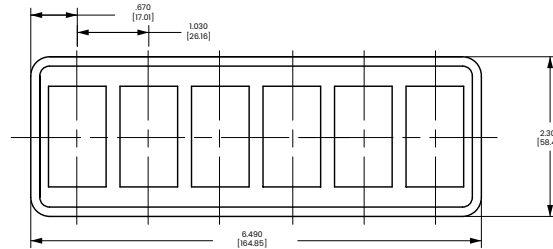

VM6 MOUNTING PANEL



## Contura Hole Plug Dimensional Specifications: in. [mm]

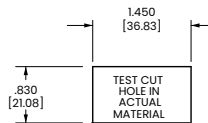

VHP CONTURA II,III HOLE PLUG

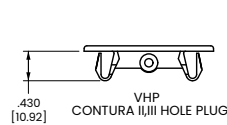

VHP CONTURA IV HOLE PLUG

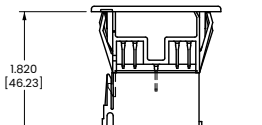

VHI STANDARD HOLE PLUG (No wing serrations) (With VC1 connector attached)

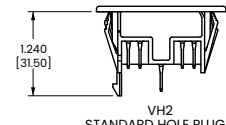

VH2 STANDARD HOLE PLUG (With wing serrations)

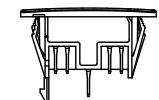
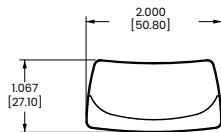

VH3 CONTURA IV HOLE PLUG (No wing serrations)

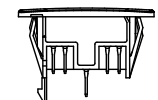

VH4 CONTURA IV HOLE PLUG (With wing serrations)



DETAIL VIEW VH1, VH3 & VH5 HOLE PLUGS (No wing serrations for ease of removal)

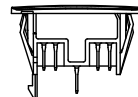
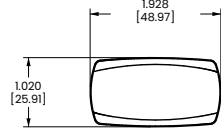

VH5 CONTURA V HOLE PLUG (No wing serrations)

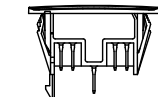

VH6 CONTURA V HOLE PLUG (With wing serrations)



DETAIL VIEW VH2, VH4 & VH6 HOLE PLUGS (With wing serrations)

# Standard Legend Codes

YK	UA	UB	US	UV	UW	UX	UY	MP	MR	PX	MS	MT
VU	MW	NZ	NX	NY	YM	VW	PS	PW	PZ	WG	WM	RN
RP	YG	TX	VD	VE	VF	VG	SH	SM	SN	SP	SR	SY
DIM	BRIGHT	UH	UJ	PD	PE	PF	VC	VJ	UF	UG	MU	TN
WY	WZ	WIPER	VZ	YE	NN	RW	PU	WA	YN	UE	NM	RJ
NS	PB	SE	VR	ENG FAN	BLWR	UC	VN	PK	VY	HORN	RH	NU
NR	YD	TL	VR	SL	VA	UC	VN	PK	VY	UZ	RH	NU
NV	RB	RC	RK	RL	MZ	RG	UP	DOWN	UD	UR	WD	TY
PA	UK	WATER PUMP	UU	ANCHOR	YR	PM	VV	WB	TB	TC	TD	TE
MY	PV	TA	TZ	WC	PT	PN	PH	RA	TU	TT	YL	SK
VS	UL	UM	WK	TS	VT	WL	VP	YJ	PJ	RY	UP	NW
NP	RE	RF	PP	PR	TV	PC	YT	YU	PL	WJ	MV	RR
TK	RT	SEAT	VX	WF	WH	PG	SJ	YA	YB	RM	TM	RD
RS	UN	TP	TR	NT	MX	YC	TW	TJ	YF	TH	TF	TG
YS	YH	AUX	ON OFF	OFF ON	I O	O I	OFF ON	ON	OFF	I	O	II
RAISE	LOWER	HIGH	LOW	FWD	REV	DEPTH	TRIM TAB	ACC	NAV ANCH	WIND LASS UP/DN	LIVE WELL	REAR
ST	SU	WU	WV	SV	SW	VB	VH	VK	VL	VM	WE	SF
PARK	AUTO	RU	RV	RX								
SG	SS											