

**CoolSiC™**  
**400V CoolSiC™ G2 MOSFET**

**Features**

- Ideal for high frequency switching and synchronous rectification
- Commutation robust fast body diode with low  $Q_{fr}$
- Low  $R_{DS(on)}$  dependency on temperature
- Benchmark gate threshold voltage,  $V_{GS(th)} = 4.5\text{ V}$
- Recommended gate driving voltage 0 V to 18 V
- .XT interconnection technology for best-in-class thermal performance
- 100% avalanche tested

**Potential applications**

- SMPS
- Solar PV inverters
- Energy storage, UPS and battery formation
- Class-D audio
- Motor drives

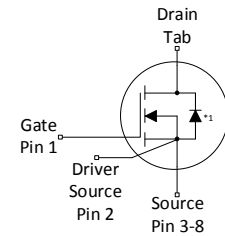
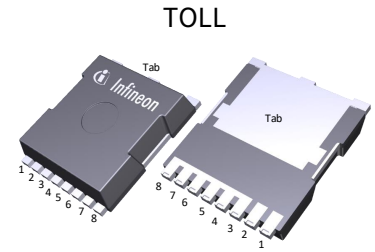
**Product validation**

Fully qualified according to JEDEC for Industrial Applications

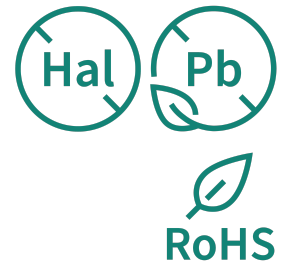
**Table 1 Key Performance Parameters**

Parameter	Value	Unit
$V_{DS}$	400	V
$R_{DS(on),typ}$	15.0	mΩ
$I_D$	111	A
$Q_{oss}$	101	nC
$E_{oss}$	7.3	μJ
$Q_G$	62	nC

Type/Ordering Code	Package	Marking	Related Links
IMT40R015M2H	PG-HSOF-8	40R015M2	-



\*1: Internal body diode





## Table of Contents

Description .....	1
Maximum ratings .....	3
Thermal characteristics .....	4
Operating range .....	4
Electrical characteristics .....	5
Electrical characteristics diagrams .....	7
Test Circuits .....	13
Package Outlines .....	14
Revision History .....	15
Trademarks .....	15
Disclaimer .....	15

## 1 Maximum ratings

at  $T_A=25\text{ °C}$ , unless otherwise specified

**Table 2 Maximum ratings**

Parameter	Symbol	Values			Unit	Note/ Test Condition
		Min.	Typ.	Max.		
Continuous drain current <sup>1)</sup>	$I_D$	-	-	111 79 11.7	A	$V_{GS}=18\text{ V}$ , $T_C=25\text{ °C}$ $V_{GS}=18\text{ V}$ , $T_C=100\text{ °C}$ $V_{GS}=18\text{ V}$ , $T_A=25\text{ °C}$ , $R_{THJA}=40\text{ °C/W}^2)$
Pulsed drain current <sup>3)</sup>	$I_{D,pulse}$	-	-	333	A	$T_C=25\text{ °C}$
Avalanche energy, single pulse <sup>4)</sup>	$E_{AS}$	-	-	162	mJ	$I_D=27.1\text{ A}$ , $R_{GS}=25\text{ }\Omega$
Avalanche energy, repetitive	$E_{AR}$	-	-	0.81	mJ	$I_D=27.1\text{ A}$ , $R_{GS}=25\text{ }\Omega$
Gate source voltage (static)	$V_{GS,DC}$	-7	-	23	V	-
Gate source voltage (transient)	$V_{GS,AC}$	-10	-	25	V	$t_{pulse} \leq 500\text{ ns}$ , duty cycle $\leq 1\%$
Power dissipation	$P_{tot}$	-	-	341 3.8	W	$T_C=25\text{ °C}$ $T_A=25\text{ °C}$ , $R_{THJA}=40\text{ °C/W}^2)$
Storage temperature	$T_{stg}$	-55	-	150	°C	-
Operating junction temperature	$T_j$	-55	-	175	°C	-

<sup>1)</sup> Rating refers to the product only with datasheet specified absolute maximum values, maintaining case temperature at 25°C. For higher case temperature please refer to Diagram 2. De-rating will be required based on the actual environmental conditions.

<sup>2)</sup> Device on 40 mm x 40 mm x 1.5 mm epoxy PCB FR4 with 6 cm<sup>2</sup> (one layer, 70 µm thick) copper area for drain connection. PCB is vertical in still air.

<sup>3)</sup> See Diagram 3 for more detailed information.

<sup>4)</sup> See Diagram 19 for more detailed information.

## 2 Thermal characteristics

**Table 3 Thermal characteristics**

Parameter	Symbol	Values			Unit	Note/ Test Condition
		Min.	Typ.	Max.		
Thermal resistance, junction - case	$R_{thJC}$	-	-	0.44	°C/W	-
Thermal resistance, junction - ambient, 6 cm <sup>2</sup> cooling area <sup>5)</sup>	$R_{thJA}$	-	-	40	°C/W	-

<sup>5)</sup> Device on 40 mm x 40 mm x 1.5 mm epoxy PCB FR4 with 6 cm<sup>2</sup> (one layer, 70 μm thick) copper area for drain connection. PCB is vertical in still air.

## 3 Operating range

**Table 4 Operating range**

Parameter	Symbol	Values			Unit	Note/ Test Condition
		Min.	Typ.	Max.		
Recommended turn-on voltage	$V_{GS(on)}$	-	18	-	V	-
Recommended turn-off voltage	$V_{GS(off)}$	-	0	-	V	-

## 4 Electrical characteristics

at  $T_j=25\text{ °C}$ , unless otherwise specified

**Table 5 Static characteristics**

Parameter	Symbol	Values			Unit	Note/ Test Condition
		Min.	Typ.	Max.		
Drain-source breakdown voltage	$V_{(BR)DSS}$	400	-	-	V	$V_{GS}=0\text{ V}$ , $I_D=0.97\text{ mA}$
Gate threshold voltage <sup>6)</sup>	$V_{GS(th)}$	3.5	4.5	5.6	V	$V_{DS}=V_{GS}$ , $I_D=9.7\text{ mA}$
Zero gate voltage drain current	$I_{DSS}$	-	1 2	75 -	$\mu\text{A}$	$V_{DS}=400\text{ V}$ , $V_{GS}=0\text{ V}$ , $T_j=25\text{ °C}$ $V_{DS}=400\text{ V}$ , $V_{GS}=0\text{ V}$ , $T_j=175\text{ °C}$
Gate-source leakage current	$I_{GSS}$	-	1	100	nA	$V_{GS}=20\text{ V}$ , $V_{DS}=0\text{ V}$
Drain-source on-state resistance	$R_{DS(on)}$	-	15.0 21.7 18.4	19.1 - -	m $\Omega$	$V_{GS}=18\text{ V}$ , $I_D=27.1\text{ A}$ , $T_j=25\text{ °C}$ $V_{GS}=18\text{ V}$ , $I_D=27.1\text{ A}$ , $T_j=175\text{ °C}$ $V_{GS}=15\text{ V}$ , $I_D=27.1\text{ A}$ , $T_j=25\text{ °C}$
Gate resistance	$R_G$	-	2.8	4.2	$\Omega$	-

<sup>6)</sup> Tested after 1ms pulse at  $V_{GS} = +20\text{V}$ .

**Table 6 Dynamic characteristics**

Parameter	Symbol	Values			Unit	Note/ Test Condition
		Min.	Typ.	Max.		
Input capacitance	$C_{iss}$	-	2100	2730	pF	$V_{GS}=0\text{ V}$ , $V_{DS}=200\text{ V}$ , $f=1\text{ MHz}$
Output capacitance	$C_{oss}$	-	300	-	pF	$V_{GS}=0\text{ V}$ , $V_{DS}=200\text{ V}$ , $f=1\text{ MHz}$
Reverse transfer capacitance	$C_{rss}$	-	24	-	pF	$V_{GS}=0\text{ V}$ , $V_{DS}=200\text{ V}$ , $f=1\text{ MHz}$
Effective output capacitance, energy related <sup>7)</sup>	$C_{o(er)}$	-	363	-	pF	$V_{GS}=0\text{ V}$ , $V_{DS}=0\dots200\text{ V}$
Effective output capacitance, time related <sup>8)</sup>	$C_{o(tr)}$	-	510	-	pF	$I_D=\text{constant}$ , $V_{GS}=0\text{ V}$ , $V_{DS}=0\dots200\text{ V}$
Turn-on delay time <sup>9)</sup>	$t_{d(on)}$	-	13.9	-	ns	$V_{DD}=200\text{ V}$ , $V_{GS}=0\dots18\text{ V}$ , $I_D=27.1\text{ A}$ , $R_{G,ext}=1.8\text{ }\Omega$
Rise time <sup>9)</sup>	$t_r$	-	15.7	-	ns	$V_{DD}=200\text{ V}$ , $V_{GS}=0\dots18\text{ V}$ , $I_D=27.1\text{ A}$ , $R_{G,ext}=1.8\text{ }\Omega$
Turn-off delay time <sup>9)</sup>	$t_{d(off)}$	-	26.5	-	ns	$V_{DD}=200\text{ V}$ , $V_{GS}=18\dots0\text{ V}$ , $I_D=27.1\text{ A}$ , $R_{G,ext}=1.8\text{ }\Omega$
Fall time <sup>9)</sup>	$t_f$	-	9.0	-	ns	$V_{DD}=200\text{ V}$ , $V_{GS}=18\dots0\text{ V}$ , $I_D=27.1\text{ A}$ , $R_{G,ext}=1.8\text{ }\Omega$

<sup>7)</sup>  $C_{o(er)}$  is a fixed capacitance that gives the same stored energy as  $C_{oss}$  while  $V_{DS}$  is rising from 0 to 200 V.

<sup>8)</sup>  $C_{o(tr)}$  is a fixed capacitance that gives the same charging time as  $C_{oss}$  while  $V_{DS}$  is rising from 0 to 200 V.

<sup>9)</sup> Refer to Table 9 for test setup.

**Table 7 Gate Charge Characteristics** <sup>10)</sup>

Parameter	Symbol	Values			Unit	Note/ Test Condition
		Min.	Typ.	Max.		
Gate to source charge	$Q_{gs}$	-	16.9	-	nC	$V_{DD}=200\text{ V}$ , $I_D=27.1\text{ A}$ , $V_{GS}=0\text{ to }18\text{ V}$
Gate to drain charge	$Q_{gd}$	-	12.8	-	nC	$V_{DD}=200\text{ V}$ , $I_D=27.1\text{ A}$ , $V_{GS}=0\text{ to }18\text{ V}$
Gate charge total	$Q_g$	-	62	-	nC	$V_{DD}=200\text{ V}$ , $I_D=27.1\text{ A}$ , $V_{GS}=0\text{ to }18\text{ V}$
Gate charge total, sync. FET	$Q_{g(sync)}$	-	58	-	nC	$V_{DS}=0.1\text{ V}$ , $V_{GS}=0\text{ to }18\text{ V}$
Output charge	$Q_{oss}$	-	101	-	nC	$V_{DS}=200\text{ V}$ , $V_{GS}=0\text{ V}$
Output Energy	$E_{oss}$	-	7.3	-	μJ	$V_{DS}=200\text{ V}$ , $V_{GS}=0\text{ V}$

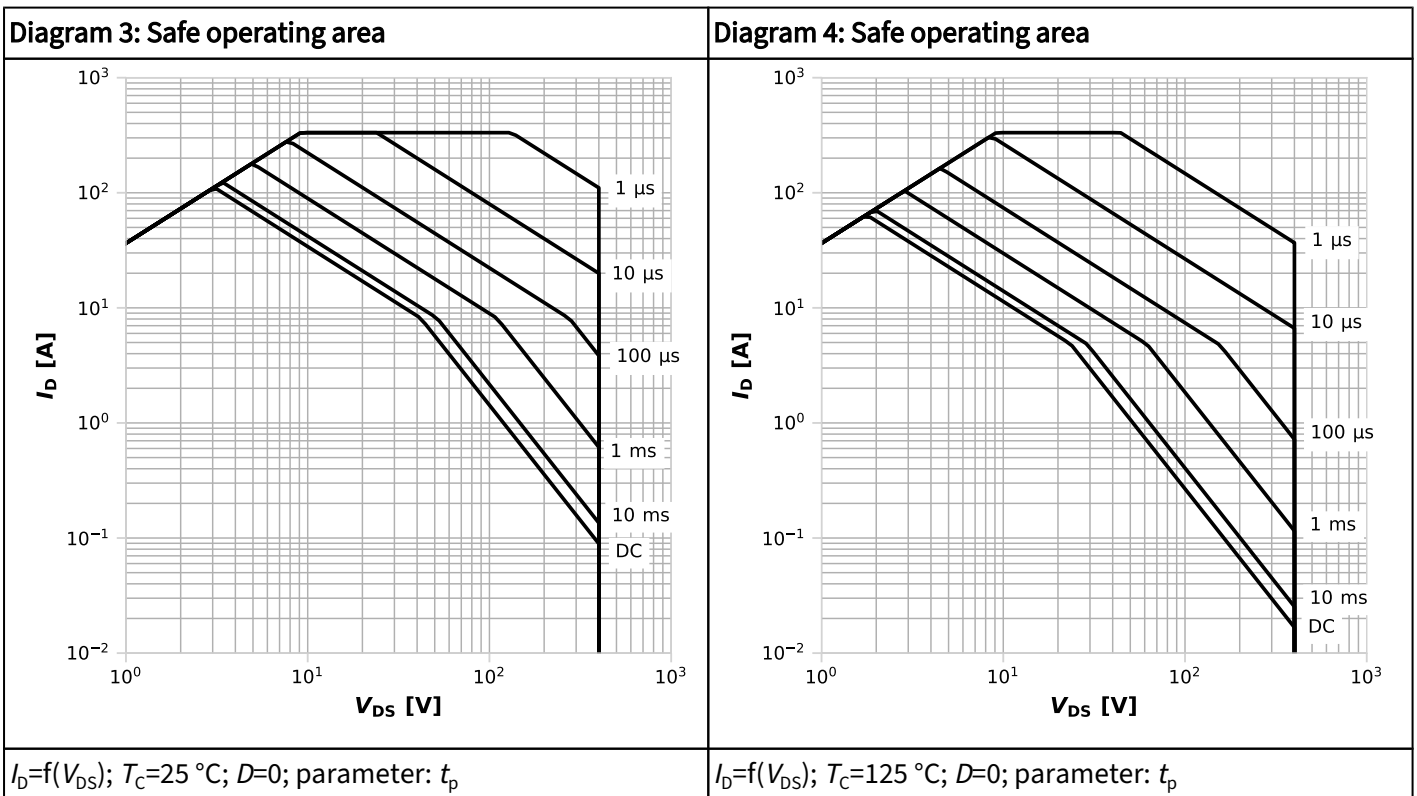
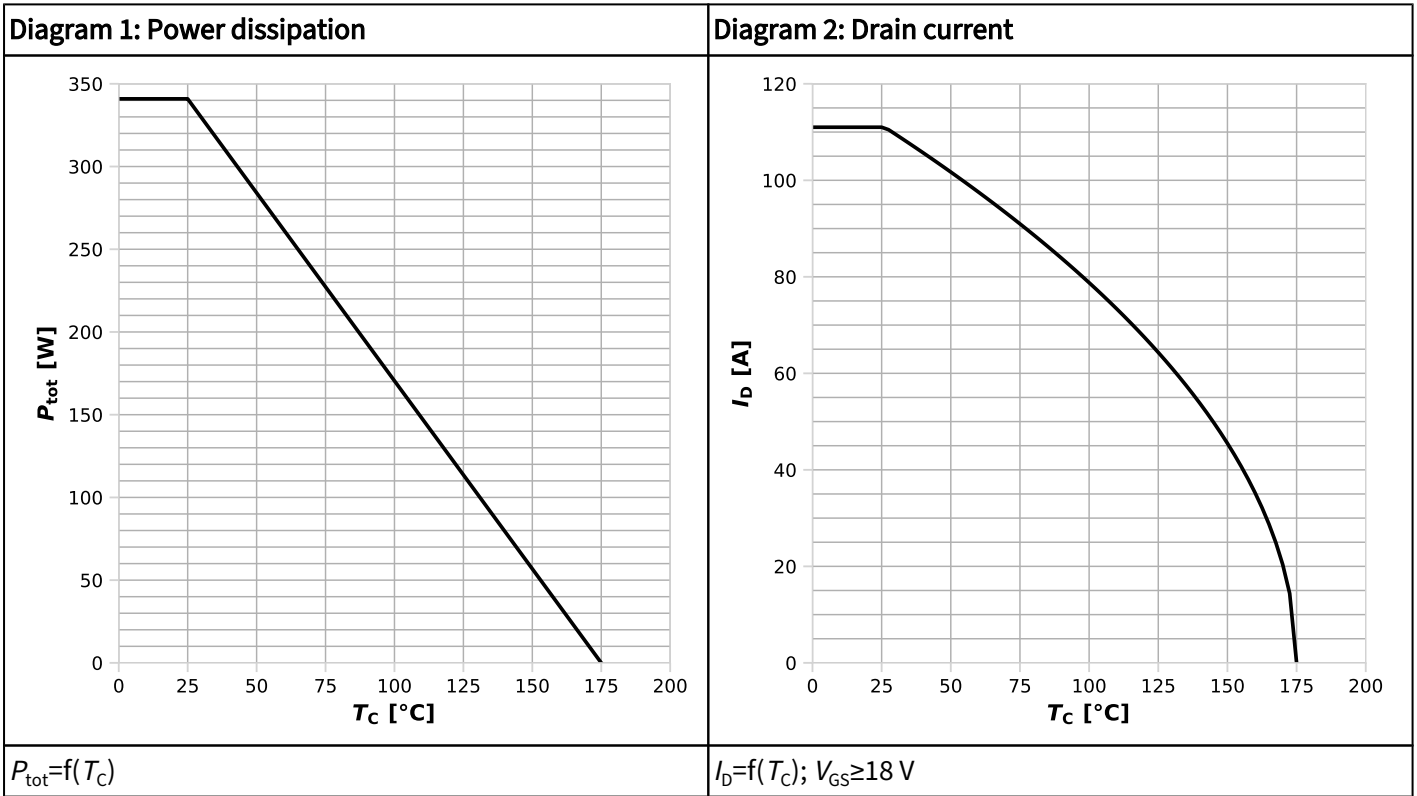
<sup>10)</sup> As per JEP192, Guidelines for Gate Charge ( $Q_g$ ) Test Method for SiC MOSFET.

**Table 8 Reverse diode characteristics**

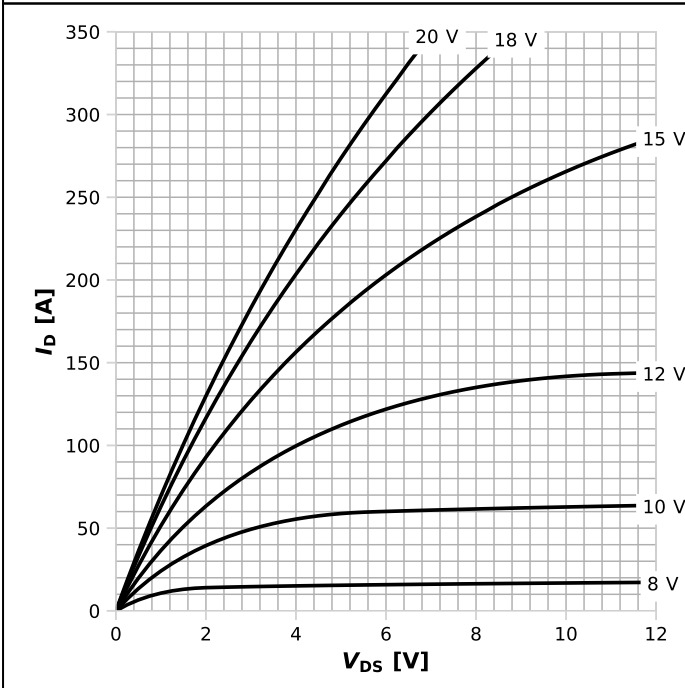
Parameter	Symbol	Values			Unit	Note/ Test Condition
		Min.	Typ.	Max.		
Diode continuous forward current	$I_S$	-	-	52	A	$T_c=25\text{ °C}$
Diode pulse current	$I_{S,pulse}$	-	-	333	A	$T_c=25\text{ °C}$ , $t_{pulse} \leq 250\text{ ns}$
Diode forward voltage	$V_{SD}$	-	3.5	4.3	V	$V_{GS}=0\text{ V}$ , $I_S=27.1\text{ A}$ , $T_j=25\text{ °C}$
MOSFET forward recovery time	$t_{fr}$	-	17.1 11.0	-	ns	$V_R=200\text{ V}$ , $I_S=27.1\text{ A}$ , $di_S/dt=1000\text{ A}/\mu\text{s}$ $V_R=200\text{ V}$ , $I_S=27.1\text{ A}$ , $di_S/dt=4000\text{ A}/\mu\text{s}$
MOSFET forward recovery charge <sup>11)</sup>	$Q_{fr}$	-	86 173	-	nC	$V_R=200\text{ V}$ , $I_S=27.1\text{ A}$ , $di_S/dt=1000\text{ A}/\mu\text{s}$ $V_R=200\text{ V}$ , $I_S=27.1\text{ A}$ , $di_S/dt=4000\text{ A}/\mu\text{s}$

<sup>11)</sup>  $Q_{fr}$  includes  $Q_{oss}$ . Refer to Table 10 for test setup.

## 5 Electrical characteristics diagrams

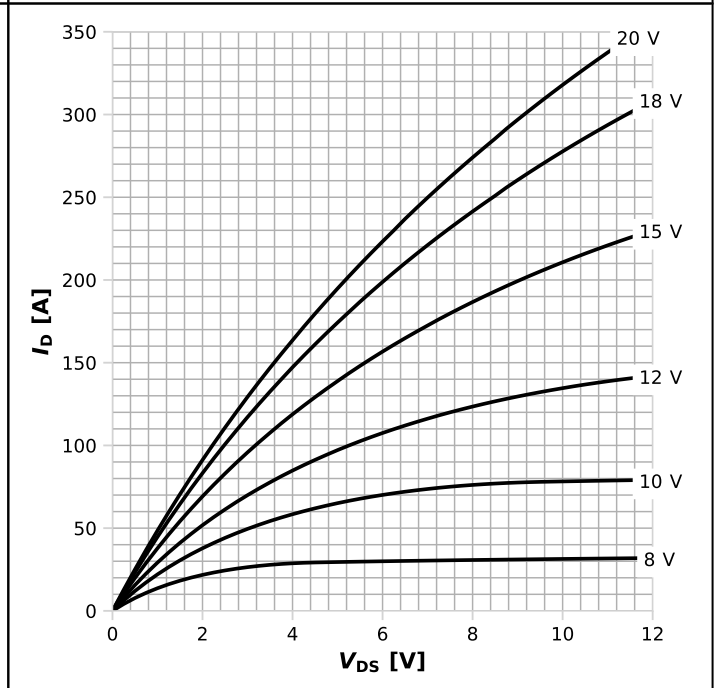


**Diagram 5: Typ. output characteristics**



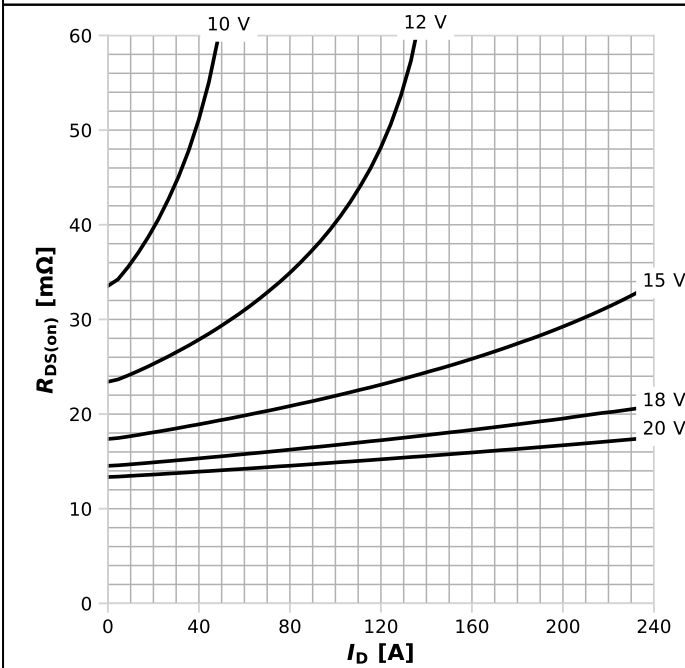
$I_D = f(V_{DS}), T_j = 25\text{ °C}; \text{parameter: } V_{GS}$

**Diagram 6: Typ. output characteristics**



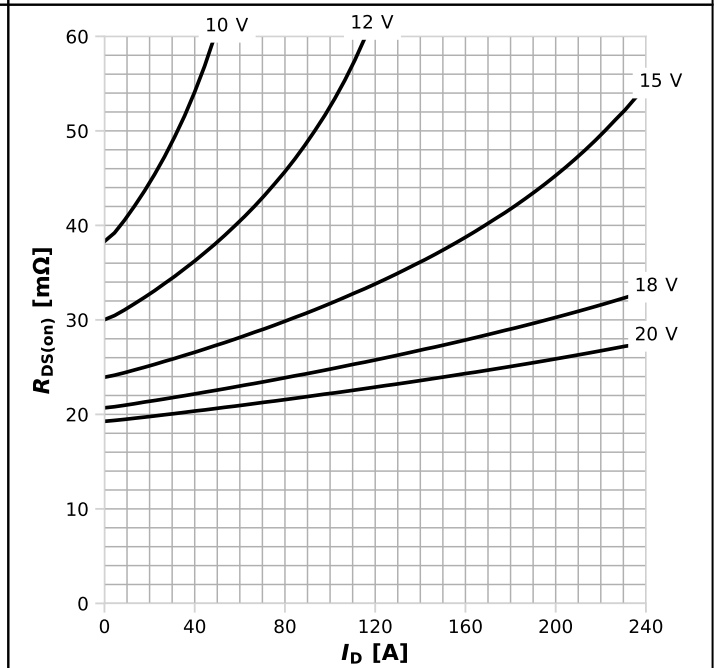
$I_D = f(V_{DS}), T_j = 175\text{ °C}; \text{parameter: } V_{GS}$

**Diagram 7: Typ. drain-source on resistance**



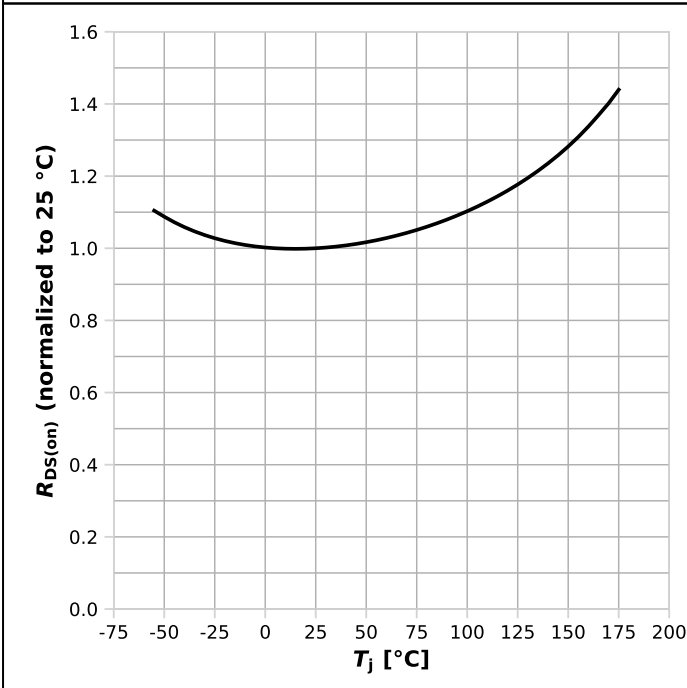
$R_{DS(on)} = f(I_D), T_j = 25\text{ °C}; \text{parameter: } V_{GS}$

**Diagram 8: Typ. drain-source on resistance**



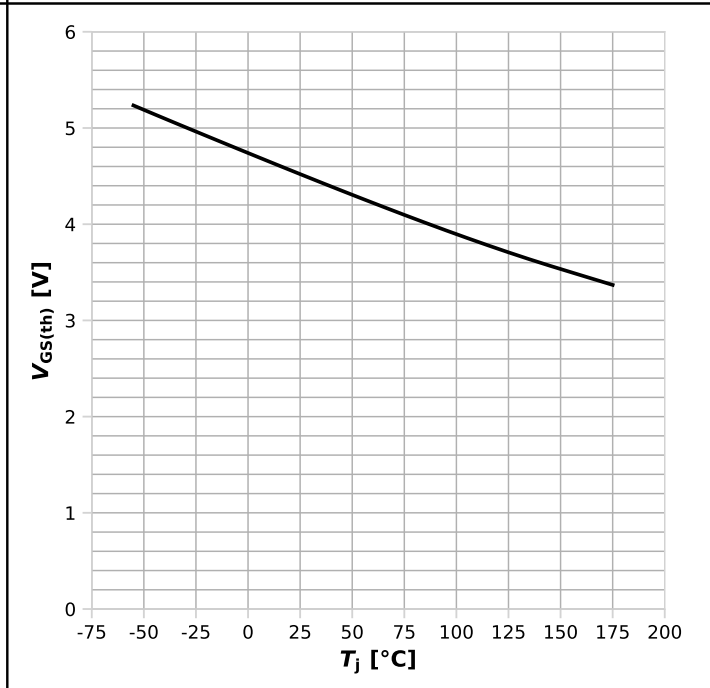
$R_{DS(on)} = f(I_D), T_j = 175\text{ °C}; \text{parameter: } V_{GS}$

**Diagram 9: Normalized drain-source on resistance**



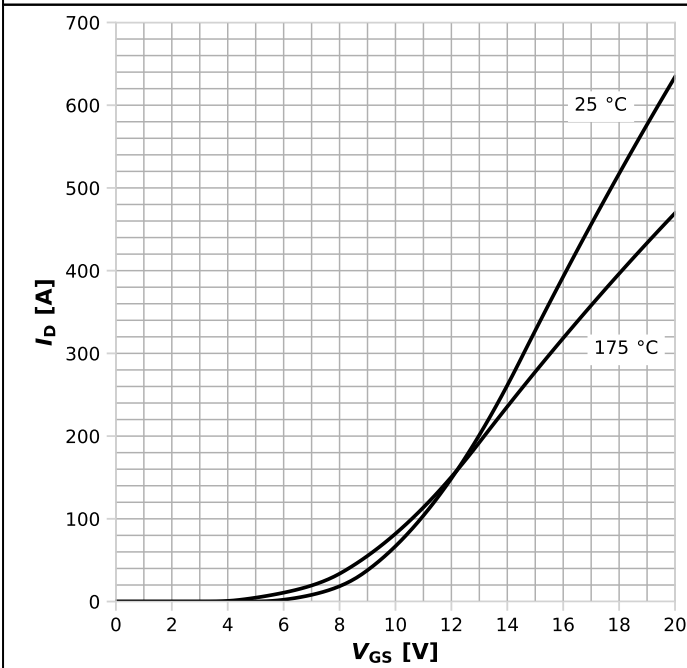
$R_{DS(on)}=f(T_j), I_D=27.1\text{ A}, V_{GS}=18\text{ V}$

**Diagram 10: Typ. gate threshold voltage**



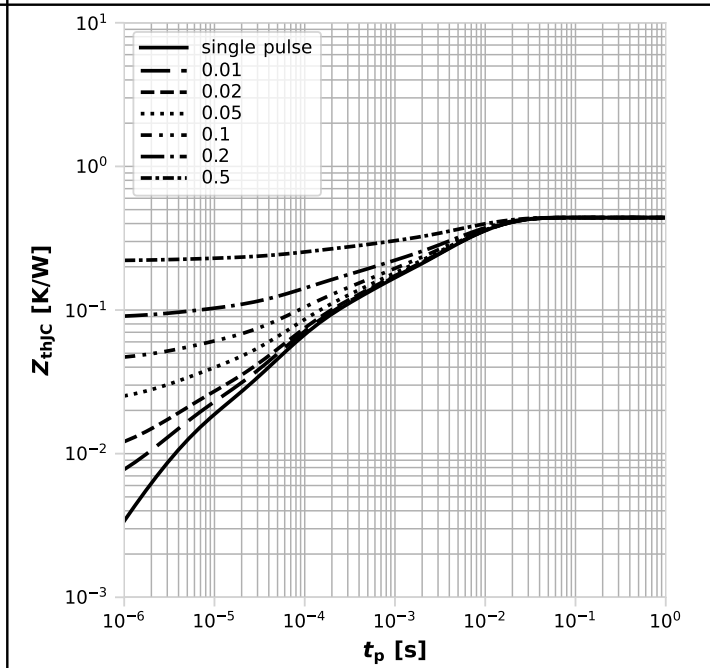
$V_{GS(th)}=f(T_j), V_{GS}=V_{DS}, I_D=9.7\text{ mA}$

**Diagram 11: Typ. transfer characteristics**



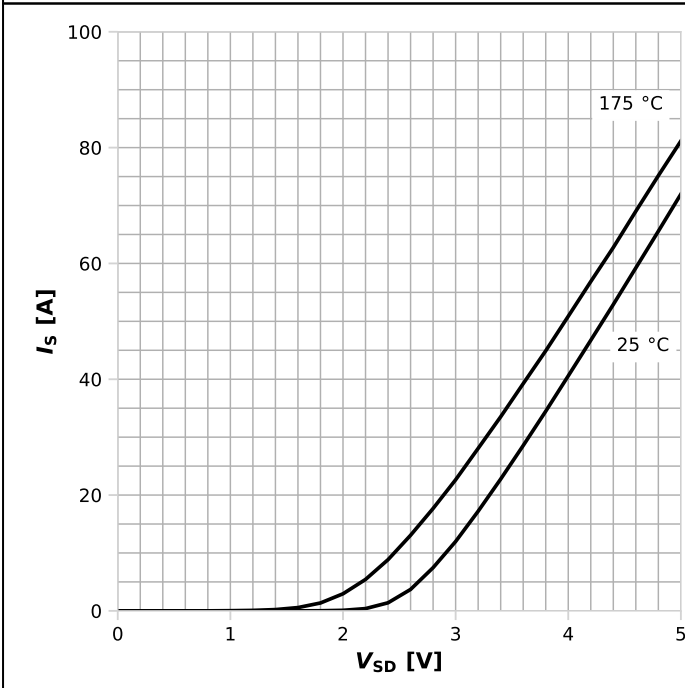
$I_D=f(V_{GS}), |V_{DS}|>2|I_D|R_{DS(on)max}; \text{parameter: } T_j$

**Diagram 12: Max. transient thermal impedance**



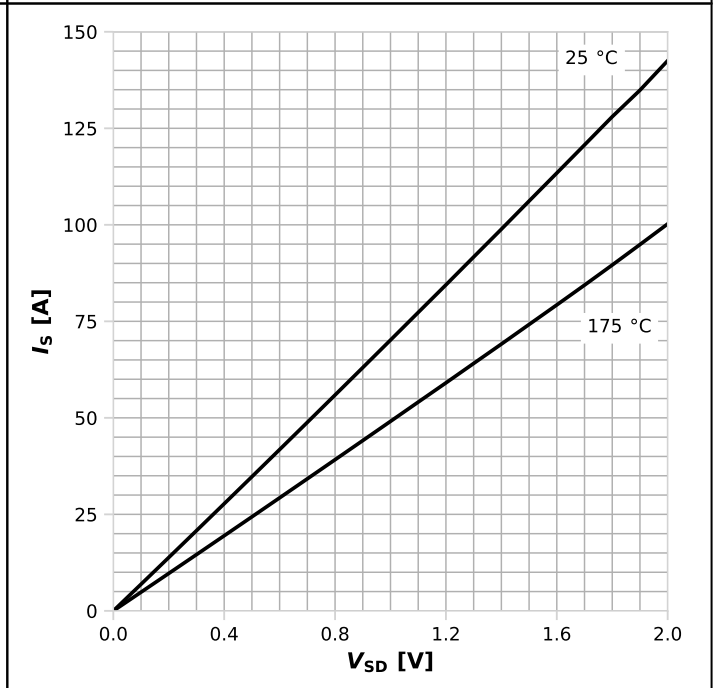
$Z_{thJC}=f(t_p); \text{parameter: } D=t_p/T$

**Diagram 13: Reverse output characteristics**



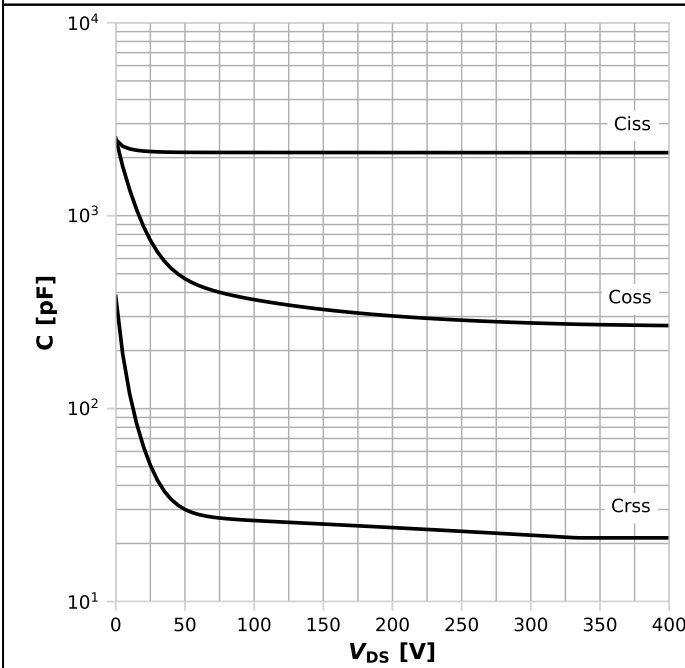
$I_F=f(V_{SD}), V_{GS}=0\text{ V}; \text{parameter: } T_j$

**Diagram 14: Reverse output characteristics**



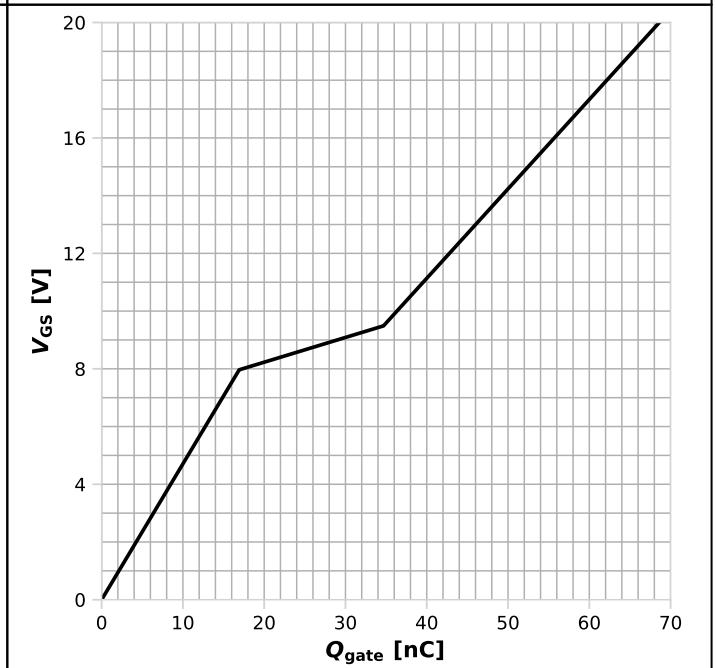
$I_F=f(V_{SD}), V_{GS}=18\text{ V}; \text{parameter: } T_j$

**Diagram 15: Typ. capacitances**



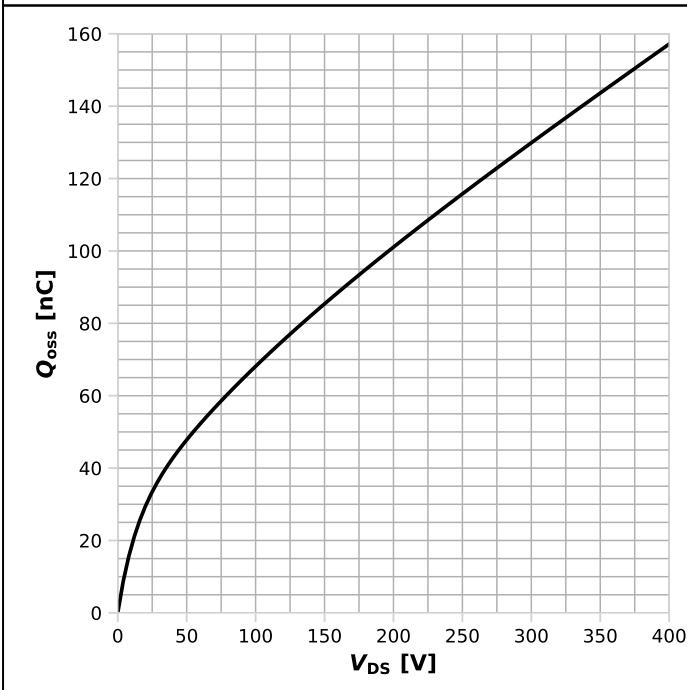
$C=f(V_{DS}); V_{GS}=0\text{ V}; f=1\text{ MHz}$

**Diagram 16: Typ. gate charge**



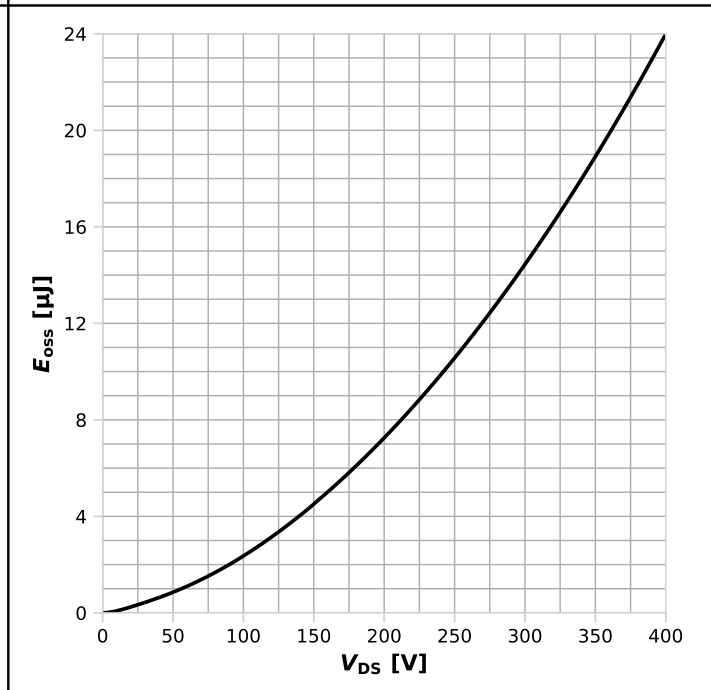
$V_{GS}=f(Q_{gate}), V_{DD}=200\text{ V}, I_D=27.1\text{ A pulsed}, T_j=25\text{ °C}$

**Diagram 17: Typ. output charge**



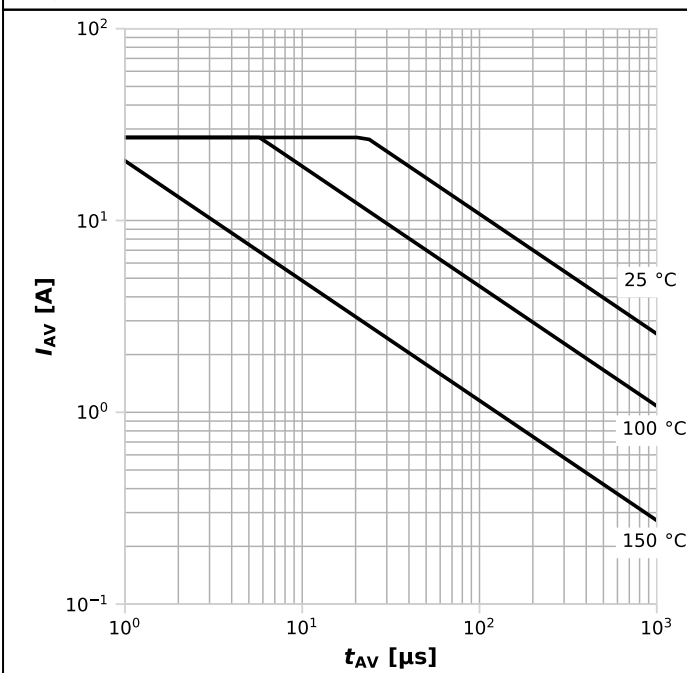
$Q_{oss}=f(V_{DS}), V_{GS}=0\text{ V}$

**Diagram 18: Typ. output energy**



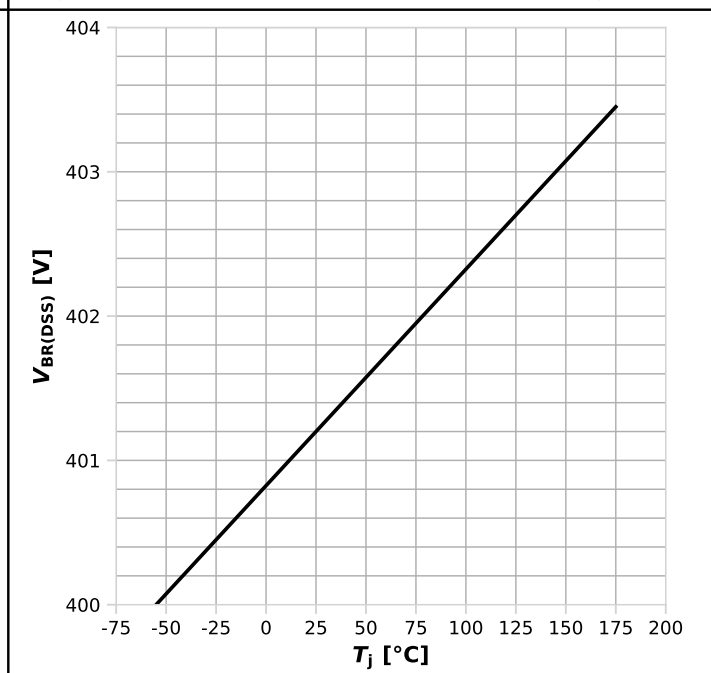
$E_{oss}=f(V_{DS}), V_{GS}=0\text{ V}$

**Diagram 19: Avalanche characteristics**

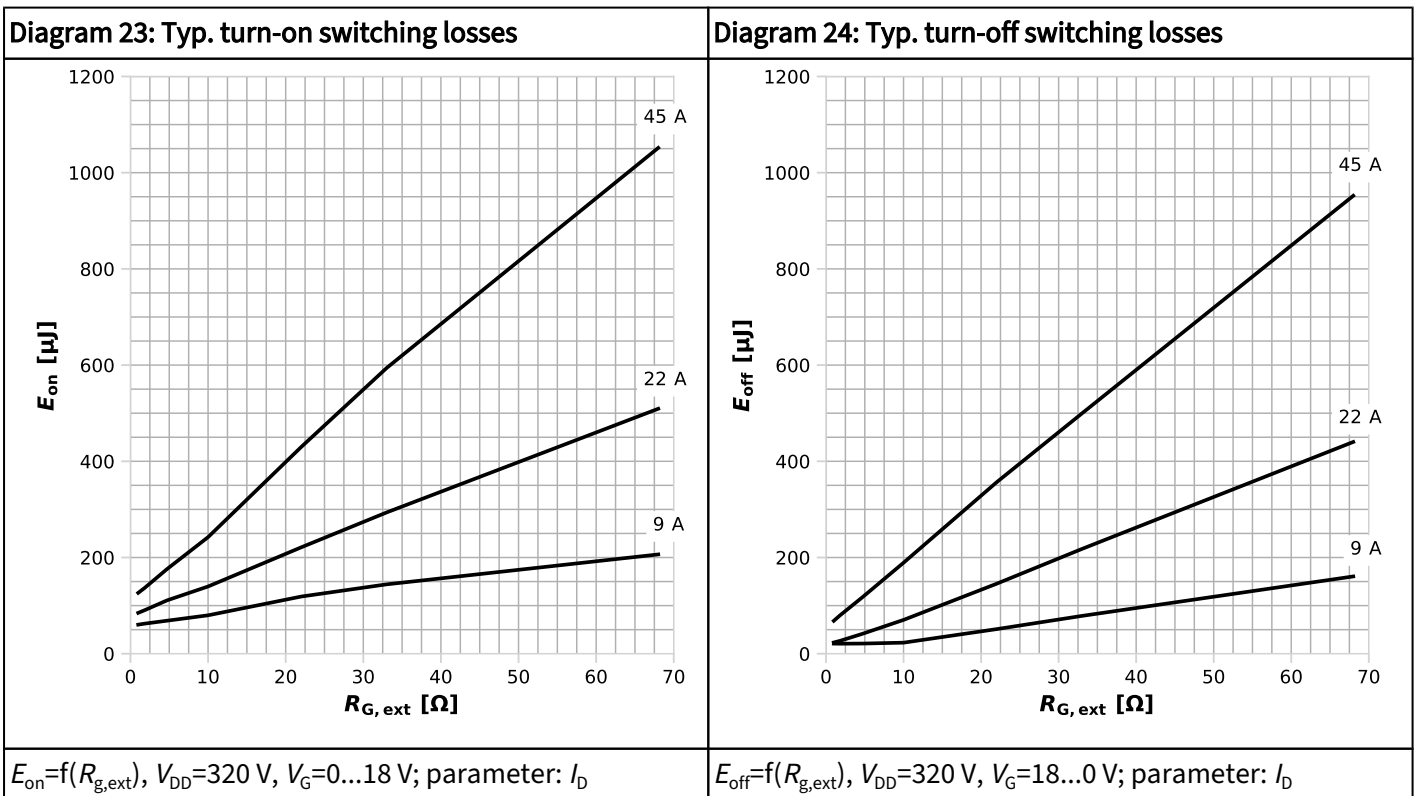
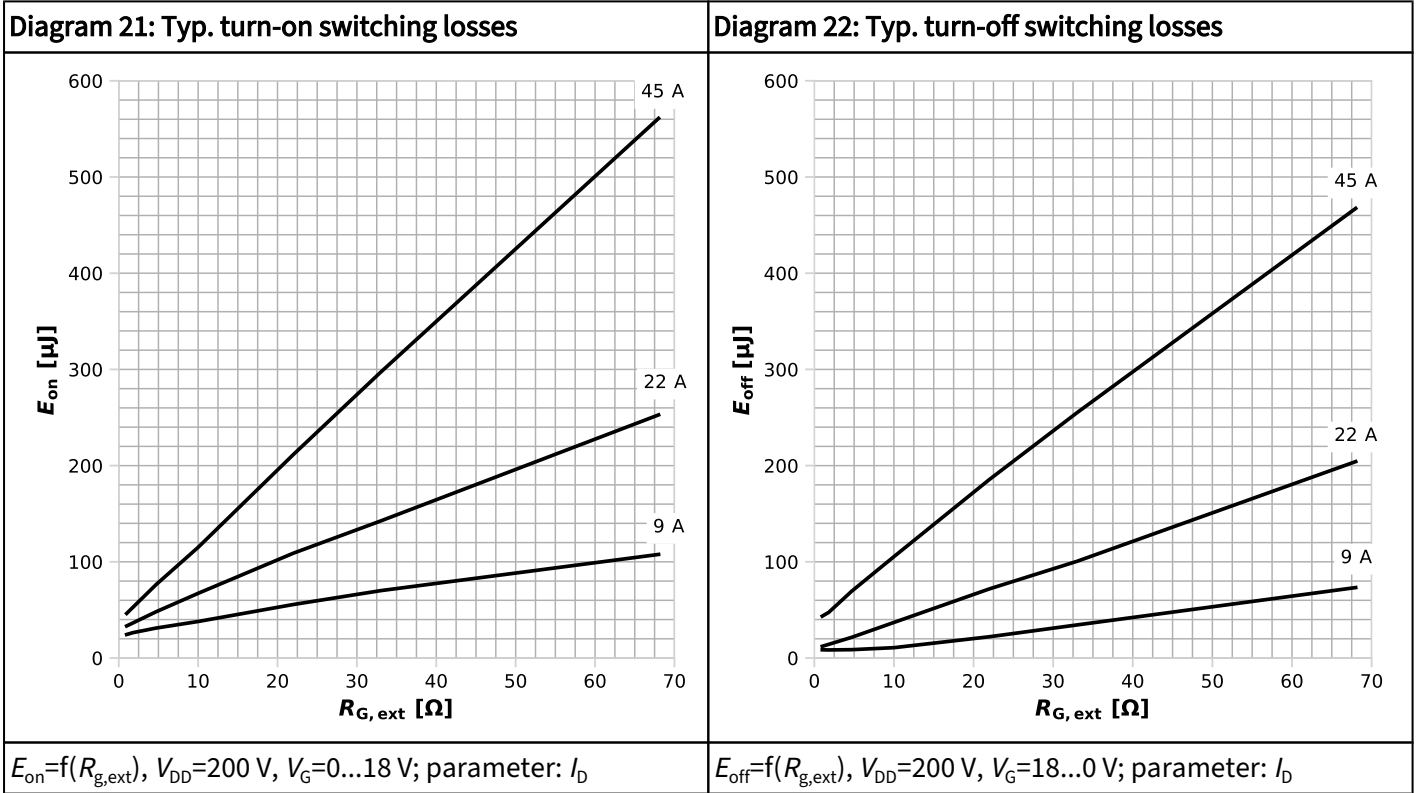


$I_{AS}=f(t_{AV}); R_{GS}=25\ \Omega; \text{parameter: } T_{j,\text{start}}$

**Diagram 20: Min. drain-source breakdown voltage**

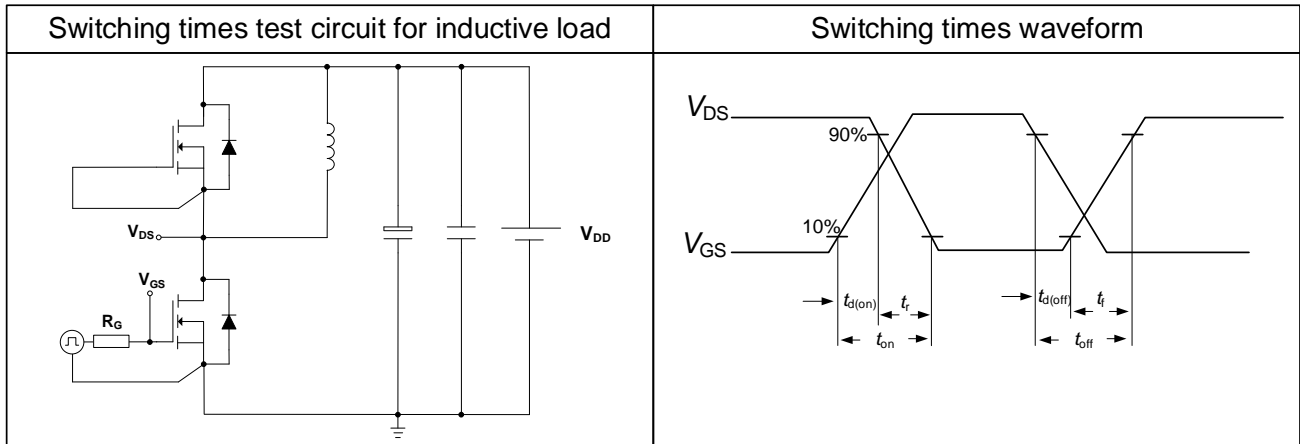


$V_{BR(DSS)}=f(T_j); I_D=0.97\text{ mA}$

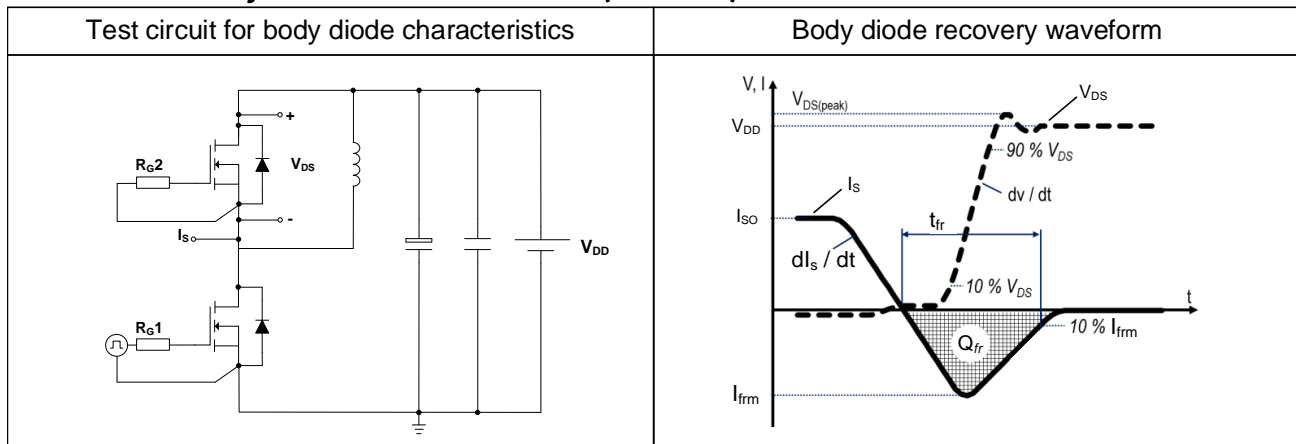


## 6 Test Circuits

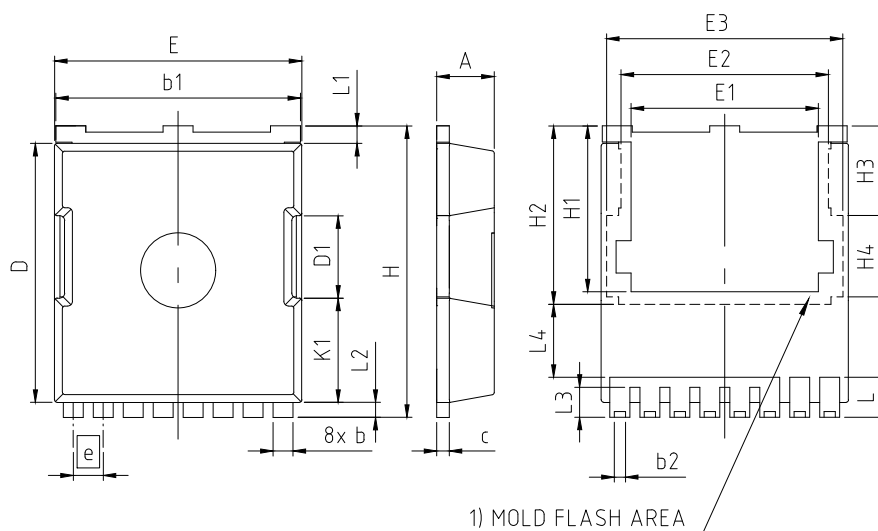
**Table 9 Switching times (CoolSiC)**



**Table 10 Body diode characteristics (CoolSiC)**



## 7 Package Outlines



PACKAGE - GROUP NUMBER: <b>PG-HSOF-8-U02</b>		
DIMENSIONS	MILLIMETERS	
	MIN.	MAX.
<b>A</b>	2.20	2.40
<b>b</b>	0.70	0.90
<b>b1</b>	9.70	9.90
<b>b2</b>	0.42	0.50
<b>c</b>	0.40	0.60
<b>D</b>	10.28	10.58
<b>D1</b>	3.30	
<b>E</b>	9.70	10.10
<b>E1</b>	7.50	
<b>E2</b>	8.50	
<b>E3</b>	9.46	
<b>e</b>	1.20 (BSC)	
<b>H</b>	11.48	11.88
<b>H1</b>	6.55	6.95
<b>H2</b>	7.15	
<b>H3</b>	3.59	
<b>H4</b>	3.26	
<b>N</b>	8	
<b>K1</b>	4.18	
<b>L</b>	1.40	1.80
<b>L1</b>	0.50	0.90
<b>L2</b>	0.50	0.70
<b>L3</b>	1.00	1.30
<b>L4</b>	2.62	2.81

1) PARTIALLY COVERED WITH MOLD FLASH

**Figure 1 Outline PG-HSOF-8, dimensions in mm**

## Revision History

IMT40R015M2H

### Revision 2024-04-27, Rev. 2.0

Previous Revision

Revision	Date	Subjects (major changes since last revision)
1.0	2024-04-26	Release of preliminary version
2.0	2024-04-27	Release of final

#### Trademarks

All referenced product or service names and trademarks are the property of their respective owners.

**We Listen to Your Comments** Any information within this document that you feel is wrong, unclear or missing at all? Your feedback will help us to continuously improve the quality of this document. Please send your proposal (including a reference to this document) to: [erratum@infineon.com](mailto:erratum@infineon.com)

#### Published by

Infineon Technologies AG  
81726 München, Germany  
© 2024 Infineon Technologies AG  
All Rights Reserved.

#### Legal Disclaimer

The information given in this document shall in no event be regarded as a guarantee of conditions or characteristics ("Beschaffenheitsgarantie"). With respect to any examples, hints or any typical values stated herein and/or any information regarding the application of the product, Infineon Technologies hereby disclaims any and all warranties and liabilities of any kind, including without limitation warranties of non-infringement of intellectual property rights of any third party.

In addition, any information given in this document is subject to customer's compliance with its obligations stated in this document and any applicable legal requirements, norms and standards concerning customer's products and any use of the product of Infineon Technologies in customer's applications.

The data contained in this document is exclusively intended for technically trained staff. It is the responsibility of customer's technical departments to evaluate the suitability of the product for the intended application and the completeness of the product information given in this document with respect to such application.

#### Information

For further information on technology, delivery terms and conditions and prices please contact your nearest Infineon Technologies Office ([www.infineon.com](http://www.infineon.com)).

#### Warnings

Due to technical requirements, components may contain dangerous substances. For information on the types in question, please contact the nearest Infineon Technologies Office.

The Infineon Technologies component described in this Data Sheet may be used in life-support devices or systems and/or automotive, aviation and aerospace applications or systems only with the express written approval of Infineon Technologies, if a failure of such components can reasonably be expected to cause the failure of that life-support, automotive, aviation and aerospace device or system or to affect the safety or effectiveness of that device or system. Life support devices or systems are intended to be implanted in the human body or to support and/or maintain and sustain and/or protect human life. If they fail, it is reasonable to assume that the health of the user or other persons may be endangered.