

## Overview

Multilayer piezoelectric actuators are ceramic components that convert electrical energy into precise mechanical motion—such as displacement or force—by leveraging the piezoelectric longitudinal effect.

KEMET multilayer piezoelectric actuators are engineered using proprietary element structures and advanced piezoelectric ceramic materials with high electrostrictive coefficients. Compared with conventional piezoelectric actuators, they offer a more compact form factor while delivering higher displacement and force at lower operating voltages.

The AS series (resin-coat-less, high-speed drive) combines low drive voltage with excellent heat resistance, making it well suited for high-speed actuation applications. In contrast, the AE series features a resin-coated structure optimized for standard operating conditions.

## Applications

Typical applications include vibration source, vibration controls, mirror/prism positioning, manipulators, motors, printers and dispensers.

## Benefits

- High operating frequency: up to 1 kHz
- Fast raise time: a few tens of microseconds range
- Operating temperature range from -25°C to +150°C
- Low operating voltage: 120 V or less
- RoHS/REACH compliant

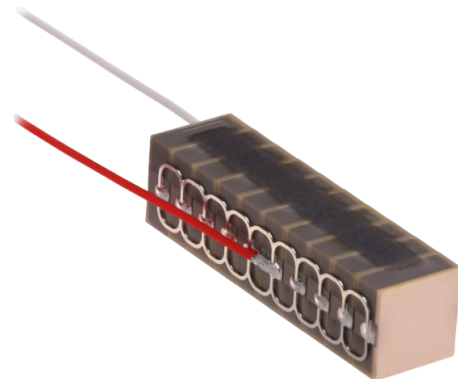

# Multilayer Piezoelectric Actuators

## AS Series Resin-Coat-Less, High Speed Drive

### Ordering Information

AS	0505	D20	H20	N	F
Series	Ceramic Cross Section (mm)	Nominal Displacement ( $\mu\text{m}$ )	Overall Length (mm)	Coating Type	Environmental Compliance
AS = Resin-Coat-Less, High Speed Drive Type	0505 = 5.2 mm X 5.2 mm	The last two digits specify the displacement values. Example: D20 = 20 $\mu\text{m}$	Height dimension Example: H20 = 20 mm	N = Coat-less type	F = RoHS/REACH compliant (See "Environmental Compliance" below)

### Application Examples

	Application Examples
Semiconductor manufacturing system	Clamping actuator of wire bonding, actuator of shaker, actuator of damping system, positioning of light source
Precision machinery, mechatronics	Dispenser, Sewing machine, robot, vibration of parts feeder, positioning of equipment, pressure sensor
Home appliances	Actuator of pump
Audio equipment	Speaker
Imaging equipment	Actuator of resolution improvement, actuator of autofocus, actuator of damping
Computer, OA equipment	Pressure sensor, positioning of memory device (data storage or others)
Optical equipment	Positioning of stage, actuator of autofocus, actuator of shaker and damping system
Communications	Polarization control, wavelength control
Medical equipment	Micropump, ultrasonic transducer, manipulators
Measuring instrument	Pressure sensor, acceleration sensor, fine positioning
Automotive	Vibration Control

## Element Structure

KEMET's multilayer piezoelectric actuators are designed using unique element structure technology and proprietary ceramic materials with high electrostrictive factors.

### Stacked partial electrode structure

- Low voltage drive
- High speed drive
- High insulation resistance

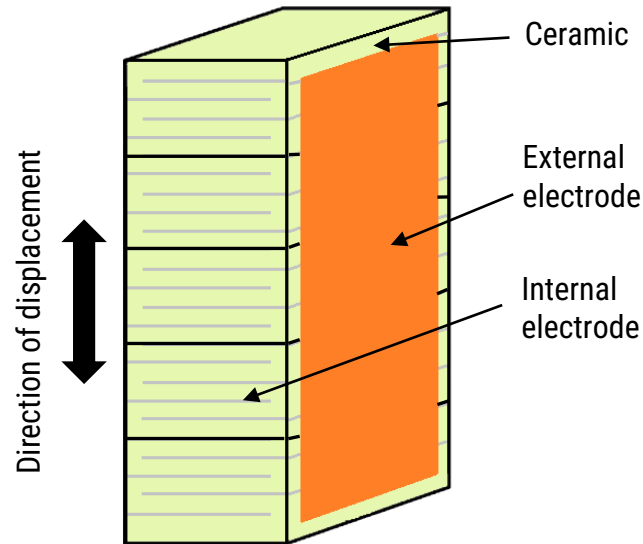

This particular structure and technology involved provide a unique product with below advantages compared to other similar solutions:

### Against electromagnetic actuators

- Faster response
- Higher resolution for positioning
- Large generated force
- Low power consumption
- No electromagnetic noise

### Against bimorph piezoelectric actuators

- 7 times the energy conversion efficiency of the bimorph type actuator
- Lower power consumption
- Large generated force
- Stable displacement, reduced shift and creep phenomena
- 100 times the response speed of the bimorph piezoelectric actuator

## Dimensions in mm

### Outer dimensions in mm

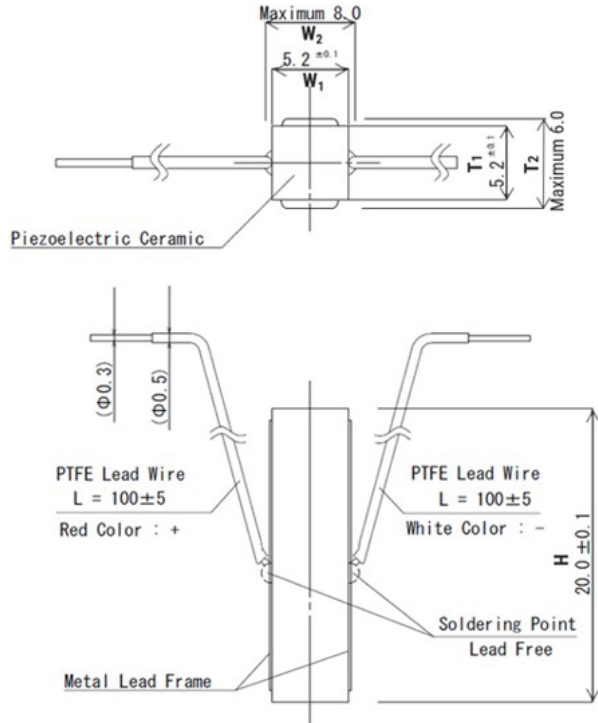

**Note:**

Factory-shipped polarization: Red lead wire = (+)  
White lead wire = (-)

Above drawings do not include dimension of wire connection area and diameter of the wire. Please contact KEMET for details.

Part Number	Outer Dimensions				
	H (mm) $\pm 0.1$	T1 (mm) $\pm 0.1$	W1 (mm) $\pm 0.1$	T2 (mm) Maximum	W2 (mm) Maximum
AS0505D20H20NF	20	5.2	5.2	6.0	8.0

**Dimensions in mm cont.**

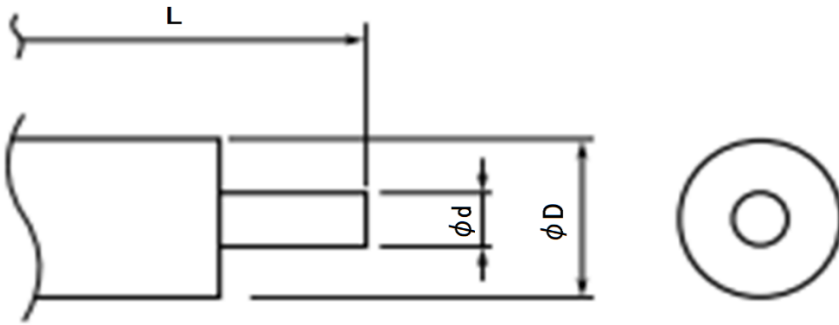

**Wire dimensions**

Note:

$\varnothing d$  = Diameter of lead wire

$\varnothing D$  = Outer diameter including the thickness of coating

L = Lead wire length

Lead wire : Copper wire with Tin plating

Coating : PTFE (Polytetrafluoroethylene)

Part Number	Outer Dimensions				
	AWG	$\varnothing d$ (mm)	$\varnothing D$ (mm)	L (mm)	UL Number
AS0505D20H20NF	30	0.3	0.5	100	1993

## Performance Characteristics

Item	Performance Characteristics	Conditions
Operating Temperature Range	-25 to +150°C	When applied with a DC voltage at ambient temperature. When driven by an AC voltage at ambient temperature plus temperature rise due to heat generation.
Recommended Storage Condition	-5 to +40°C / less than 40% R.H.	No condensation. Recommended storage to be at room temperature.
Maximum Driving Voltage	120 VDC	
Displacement	See Table 1 - Ratings & Part Number Reference	At 120 VDC
Generated Force (Compression Resistance)	See Table 1 - Ratings & Part Number Reference	The force required for restricting the displacement to zero when the maximum driving voltage is applied.
Capacitance	See Table 1 - Ratings & Part Number Reference	f = 1 kHz, V = 1 V <sub>rms</sub> (< 10 μF)
Capacitance Tolerance	±20%	
Dissipation Factor	5% or less	
Insulation Resistance	See Table 1 - Ratings & Part Number Reference	Value obtained in one minute at 120 VDC.
Temperature Cycle Test	Displacement: Initial value ±20% Capacitance: Initial value ±30% tan δ: Less than initial rated value Insulation Resistance: 1 MΩ or more	Room temperature (3 minutes) At -25°C for 30 minutes Room temperature (3 minutes) At +150°C for 30 minutes Repetition of 10 cycles of the above

## Environmental Compliance

All KEMET Multilayer Piezoelectric Actuators are RoHS and REACH Compliant.

Article 33(1) of the REACH Regulation states that manufacturers and importers of articles (products) are required to notify their customers of the presence of any Substances of Very High Concern (SVHC) in their products exceeding 0.1% by weight and provide instructions on safe use of the product.

KEMET Corporation reports regarding the Article 33(1) of REACH Regulation as follows:

**1. Applicable Product:**

Multilayer piezoelectric actuators (AE, AER, AL, AS, ASB, ASL and AHB Series)

**2. Report for content of REACH SVHC list:**

The product(s) above contain a substance by more than 0.1wt% per product weight that was published in the 8th update of the REACH SVHC substances (December 19, 2012).

**3. Regarding safety of the multilayer piezoelectric actuators (Piezoceramic products):**

The Piezoceramic that is used in this product becomes ceramic by sintering powder containing PZT as a main ingredient. It is chemically stable, with minimum risks toward the human body or environment within the intended use of the product. Please note that risks could occur in the case of inhalation or accidental oral uptake of powder ceramics.

**4. Technical product information on the multilayer piezoelectric actuators (Piezoceramic products):**

The manufacturing technique of the “piezoceramic products” whose main ingredient is Lead Titanium Zirconium Oxide (PZT) has been established, and there is no alternative material that can exhibit superior performance than PZT at this moment. Please note that the piezoceramic is listed as an exempt on RoHS (2011/65/EU) Annex III (7c.1).

**5. Responsibility of piezoceramic manufacturers:**

Piezoceramic manufacturers report information regarding PZT containment in their products to the customers to obey the article 33 of the REACH regulation.



**Table 1 – Ratings & Part Number Reference**

Part Number	Electrical		Energy/Power	Physical				
	Capacitance (µF)	Insulation Resistance (MΩ)	Generated Force (N)	Cross Section (mm)	Overall Length (mm)	Displacement (µm) at Maximum Voltage of 120 VDC	Stiffness (N/µm)	Weight (g)
AS0505D20H20NF	1.2	50.0	650	5.2x5.2	20	19.0 ±3.0	34.0	5.0

## Electrical Characteristics

Figure 1 - Voltage vs. Displacement

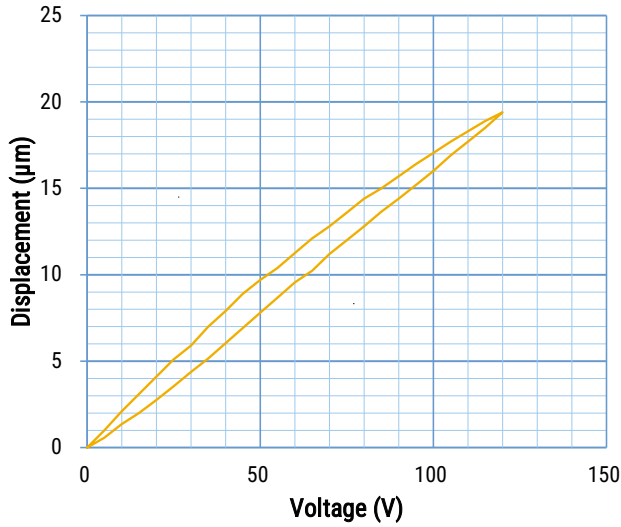

Figure 2 - Generated Force vs. Displacement of AS0505D20H20NF in Driving Voltage

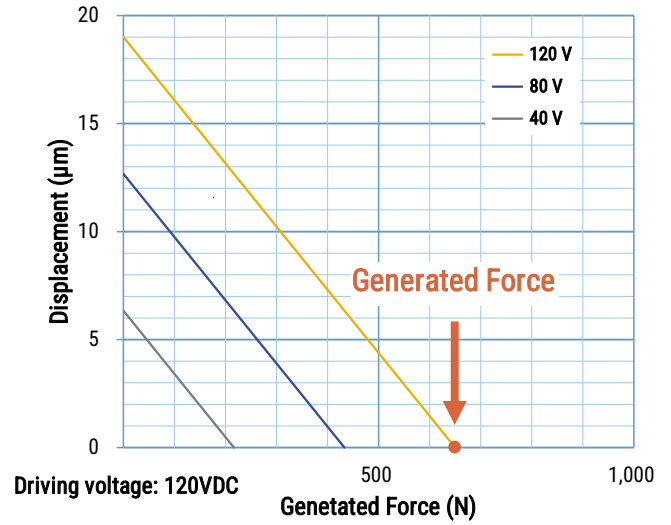
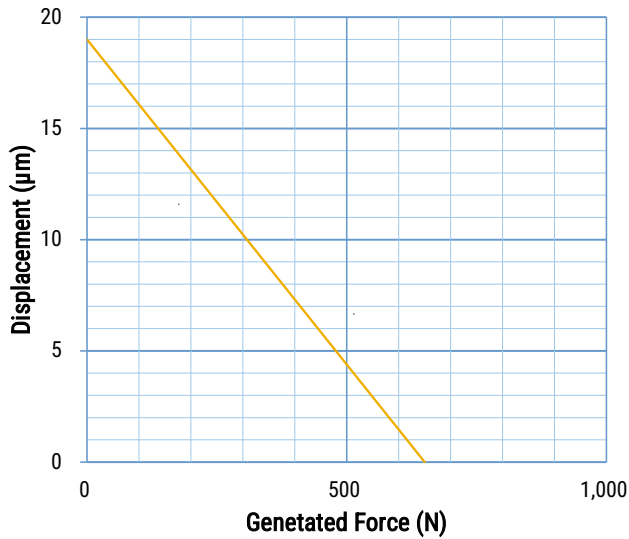

Figure 3 - Generated Force vs. Displacement



Electrical Characteristics cont.

Figure 4 - Temperature vs. Displacement

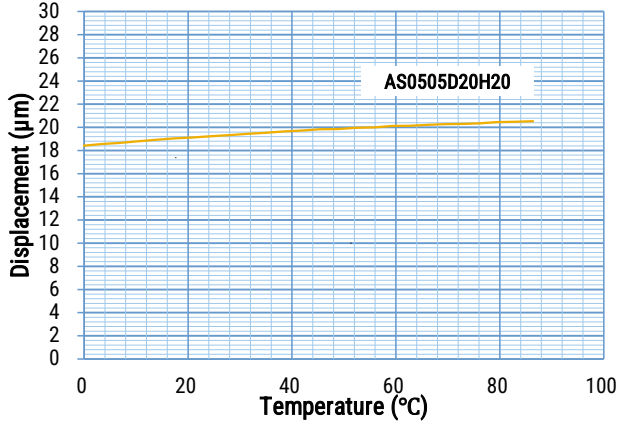
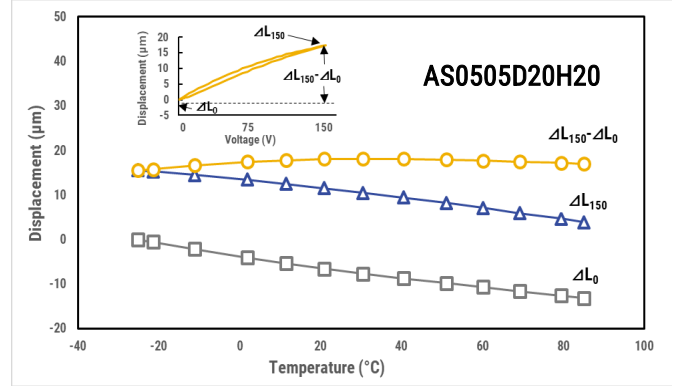

Figure 5 - Temperature vs. Displacement



Notes:

\* Listed data are reference values.

\* Definition of generated force for figures 2 and 3: force required for restricting the displacement to 0 when the maximum driving voltage is applied.

Figure 6 - Heat Generation vs. Drive Frequency - 1  
Model: AS0505D20H20NF

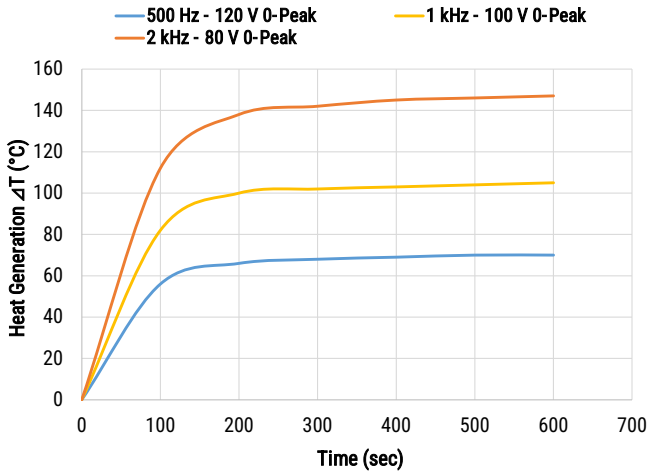
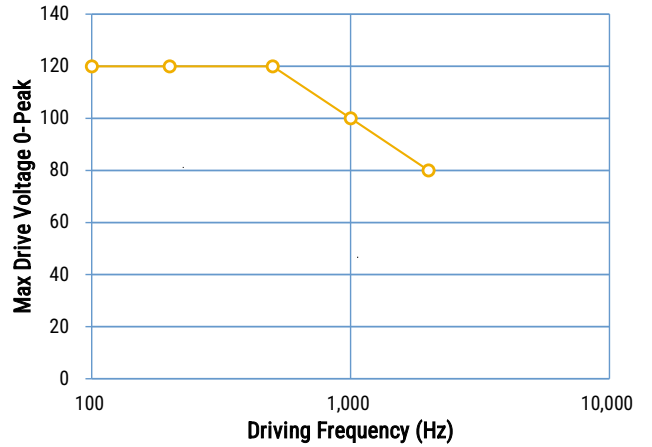
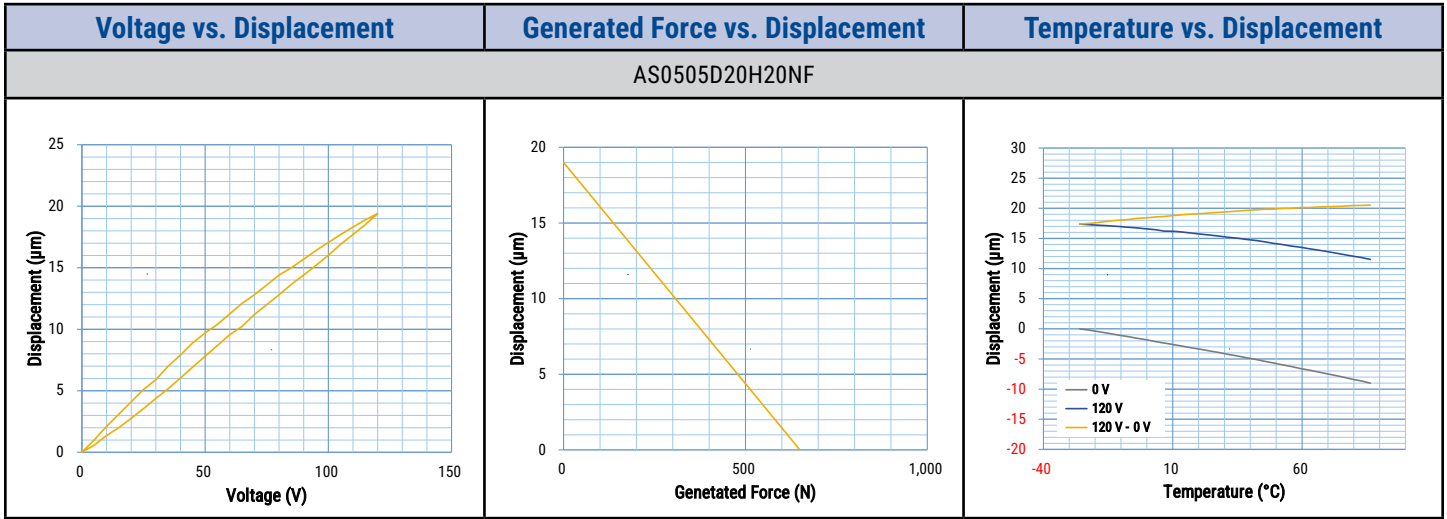

Figure 7 - Frequency vs. Max Drive Voltage  
Model: AS0505D20H20NF  
Condition: Square wave Duty 50%



Electrical Characteristics cont.



- Notes:
- \* Listed data are reference values. For the voltage vs. displacement characteristics, the same length of piezo series shows the same voltage vs. displacement characteristics.
  - \* Definition of generated force for figures 2, 3 and 4: force required for restricting the displacement to 0 when the maximum driving voltage is applied.

## Packaging

Part Type	Packaging Type	Pieces
AS0505	Bulk	4

## Reliability

The majority of failure modes on multilayer piezoelectric actuators are short-circuits due to degraded insulation. Although the cause of degradation of insulation has not been clarified, it has been found that the failure rate varies greatly between static uses (DC voltage application) and dynamic uses (pulse voltage application). Like other electrical components, piezoelectric actuators are affected by not only the applied voltage and ambient temperature but also humidity in environments below 100°C.

### DC Voltage Application

Test result:

- High temperature drive test : Average lifetime is over 1,000 hours in a DC 120V test at 120°C
- Low temperature drive test : Average lifetime is over 1,000 hours in a DC 120V test at -40°C
- High temperature, high humidity drive test : Average lifetime is over 500 hours in a DC 120V test at 40°C and 90%RH.

### Pulse Voltage Application

In driving dynamic applications, temperature rises as a result of self-heating allowing the component not to be affected by the humidity, thus extending the operational lifetime. This phenomenon is explained as a result of the humidity factor elimination caused by the self-heating. Since the self-heating value is affected by multiple factors such as the element's shape, pulse waveform and frequency, it is difficult to estimate the actual rising value. Therefore, the life of the actuator cannot be determined by using an equation, unlike the case of DC voltage applications. When testing the AS0505D20H20NF part, there was no failure confirmed after 1 billion times end of the pulse driving test. (1 kHz, 0 – 120 V rectangular pulse). Users should be careful about the influence of physical damage which can be caused by the fixing method of the element and/or the driving conditions.

## User's Guide

### Fixing Method

- Carefully prevent the piezoelectric actuators from being bent, twisted or applied tensile force.

Reference: Twisting and Tension Tolerance

	Reference Value	Remarks
Twisting Force	$3 \times 10^{-1} \text{ N} \cdot \text{m}$ or less	For an actuator which generates a force of 800 N (compression resistance).
Tension	50 N or less	

- Install the actuator so that the center axis of the generated displacement is aligned with the center axis of the load.
- Epoxy-based adhesives are recommended for bonding. Select adhesives that have high rigidity and allow for medium thickness so that the generation force and displacement cannot be deteriorated. Also, do not form adhesives on the side of the actuator.
- When thermosetting resin is used, perform polarizing treatment (see caution section) after the adhesive is settled.
- The resin coated type is weak to the tensile force due to its structure and may be broken when tensile forces are applied onto the device. Using the device in the state that constantly applies compression is effective against any mechanical damage. The pressure applied to this element should be kept at 20% to 50% of the force generated by this element (compression resistance).
- Install the element so that the axis of generated displacement is vertical to the mounting surface.

### Example of Actuator mounting :

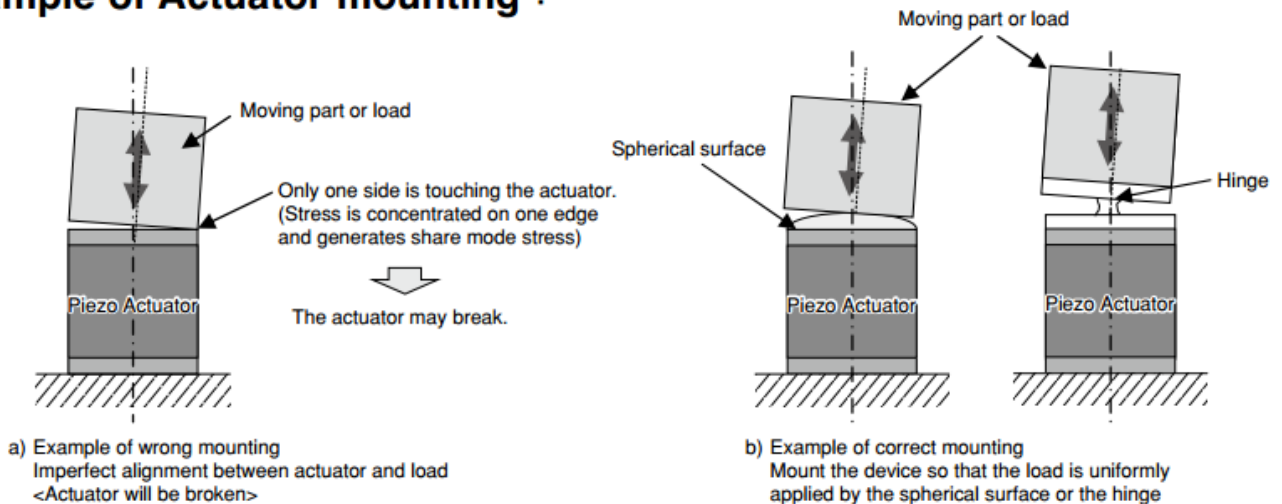

### Driving Method

- Connect the red lead wire to the positive (+) terminal of the power supply. Also prevent reverse voltage application.
- In driving applications, it is necessary to take consideration of hysteresis, ringing, creep, and other similar phenomenons.
- For pulse driving, it is also necessary to be aware of self-heat generation, charge/discharge current, and the power supply's impedance.

User's Guide cont.

Generated Force and Load Relation

Static load: No load value changes when actuator moves.

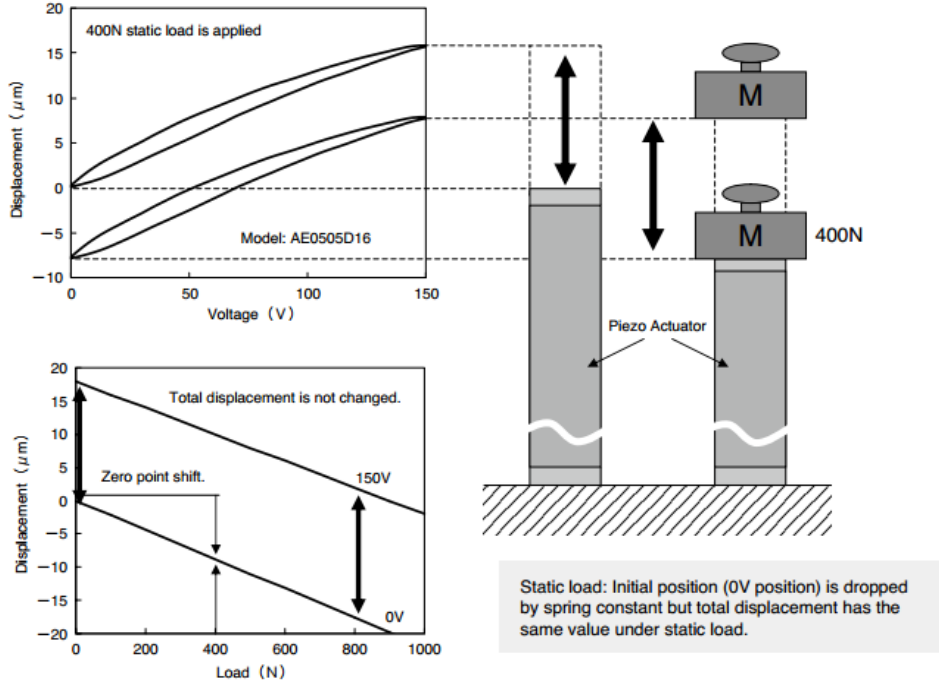

Fluctuating load: Load value changes by spring reaction when actuator moves.

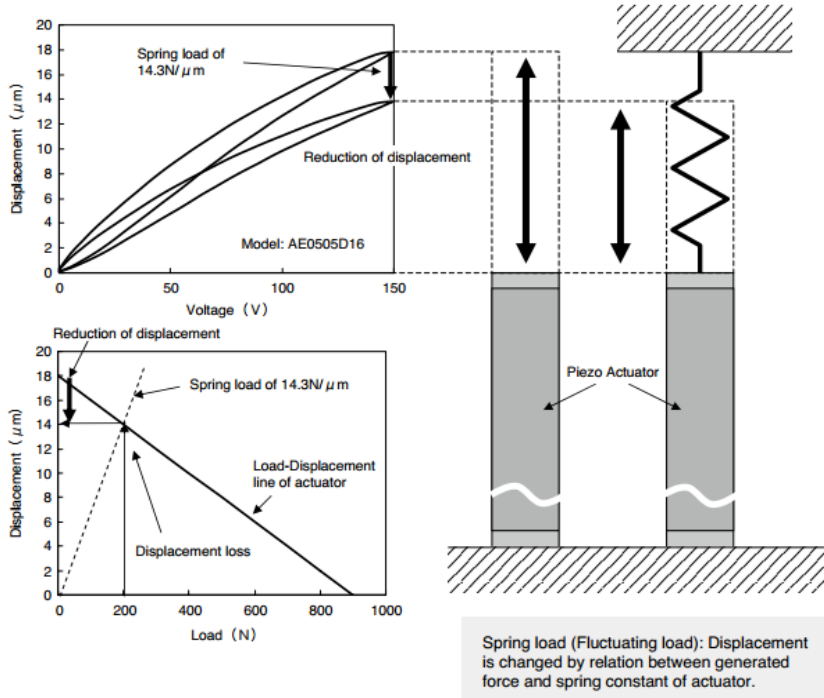

## Handling Precautions

### Precautions to be taken when using multilayer piezoelectric actuators (Please read these precautions before using our products)

1. Before using or designing a system using our products, read the precautions and specifications listed below.
2. The main failures with multilayer piezoelectric actuators are deterioration of insulation resistance, short-circuit and open-circuit.  
Before using the products, systems should be designed carefully to ensure redundancy, prevention of the spread of fire, and prevention of faulty operation allowing occurrence of failures.
3. Use the products after checking the working conditions and rated performance of each multilayer piezoelectric actuator series.  
Selection of AE, AER or AL Series (resin coated type) or AS Series (resin-coat-less type) or ASB, ASL or AHB Series (metal sealed type) should be based on the intended working temperature and humidity.

- Connect the red lead wire to the positive (+) terminal of the power supply.
- Avoid electric shocks since a high voltage is in use.
- Never apply excessive tension to a lead wire.
- Do not handle the product by picking up or moving the lead wire.
- Machining of the actuator element and replacement of the lead wire are prohibited.
- Do not handle the resin-coat-less type (AS series) with bare hands.
- Do not wash the resin-coat-less type (AS series) with organic solvents.
- Avoid excessive physical shock. Otherwise, the internal piezoelectric ceramic element may be damaged.
- To avoid product failure, ensure the product is installed without its side touching anything.
- Do not pull the products along its displacement direction during handling.
- Do not apply twisting force to the products during handling.
- Do not touch the solder or lead frame while voltage is being applied to the piezoelectric element to avoid electric shock.
- When mounting the products, be aware that thermal effects can generate voltage due to the pyroelectric effect, and that the products and the mounting object have different thermal expansion coefficients.
- The resin-coat-less type (AS series) has passed our visual inspection and there is no effect on the properties.
- If the actuator is exposed to high temperatures above 100°C or if used after long storage periods (more than three months), the device should be polarized by using the circuit configuration and conditions shown below.
- Do not apply voltage exceeding maximum rating voltage, or rapid charging and discharging.
- Do not use the actuator in high concentrations of highly inflammable gas.
- Align the center axis of displacement of the actuator with the center axis of the mechanical load.
- When operated, the transient response time of the actuator should be less than 1/3 of the resonant frequency in order to prevent damage by ringing.
- Store The resin-coat-less type (AS series) preferably in a dry atmosphere (desirably below 40% RH) at ordinary temperatures (-5°C to +40°C). Avoid condensation on the product's surface.
- Store actuators where there is no vibration.
- Handle products properly as industrial waste. When disposing, please contact your local waste disposal service and make sure the disposal methods meet all legal requirements.

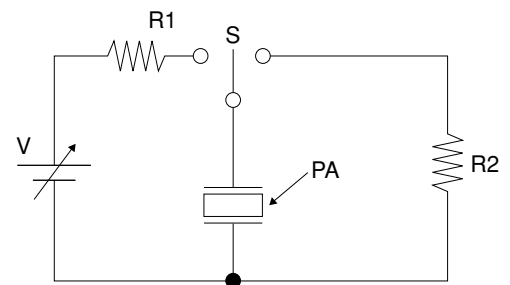

Protective resistor R1 = 1 kΩ  
Protective resistor R2 = 1 kΩ  
Polarizing conditions : DC voltage application  
0 V --> 120 ± 0.2 V (to be retained for 10 seconds) --> 0 V

## Export Control

### For customers in Japan

For products which are controlled items subject to the “Foreign Exchange and Foreign Trade Law” of Japan, the export license specified by the law is required for export.

### For customers outside Japan

Multilayer Piezoelectric Actuators should not be used or sold for use in the development, production, stockpiling or utilization of any conventional weapons or mass-destructive weapons (nuclear weapons, chemical or biological weapons, or missiles), or any other weapons.

## KEMET Electronics Corporation Sales Offices

For a complete list of our global sales offices, please visit <https://www.yageogroup.com/SalesResources/SalesOffices>

---

### Disclaimer

YAGEO Corporation and its affiliates do not recommend the use of commercial or automotive grade products for high reliability applications or manned space flight.

All product specifications, statements, information and data (collectively, the "Information") in this datasheet are subject to change. The customer is responsible for checking and verifying the extent to which the Information contained in this publication is applicable to an order at the time the order is placed. All Information given herein is believed to be accurate and reliable, but it is presented without guarantee, warranty, or responsibility of any kind, expressed or implied.

Statements of suitability for certain applications are based on KEMET Electronics Corporation's ("KEMET") knowledge of typical operating conditions for such applications, but are not intended to constitute – and KEMET specifically disclaims – any warranty concerning suitability for a specific customer application or use. The Information is intended for use only by customers who have the requisite experience and capability to determine the correct products for their application. Any technical advice inferred from this Information or otherwise provided by KEMET with reference to the use of KEMET's products is given gratis, and KEMET assumes no obligation or liability for the advice given or results obtained.

Although KEMET designs and manufactures its products to the most stringent quality and safety standards, given the current state of the art, isolated component failures may still occur. Accordingly, customer applications which require a high degree of reliability or safety should employ suitable designs or other safeguards (such as installation of protective circuitry or redundancies) in order to ensure that the failure of an electrical component does not result in a risk of personal injury or property damage.

Although all product-related warnings, cautions and notes must be observed, the customer should not assume that all safety measures are indicated or that other measures may not be required.

When providing KEMET products and technologies contained herein to other countries, the customer must abide by the procedures and provisions stipulated in all applicable export laws and regulations, including without limitation the International Traffic in Arms Regulations (ITAR), the US Export Administration Regulations (EAR) and the Japan Foreign Exchange and Foreign Trade Act.

*KEMET is a registered trademark of KEMET Electronics Corporation.*