

2305

3.3V Zero-Delay Clock Buffer

Description

The 2305 is a high-speed phase-lock loop (PLL) clock buffer, designed to address high-speed clock distribution applications. The zero-delay is achieved by aligning the phase between the incoming clock and the output clock, operable within the range of 10MHz to 133MHz.

The 2305 is an 8-pin version of the 2309. The 2305 accepts one reference input and drives out five low skew clocks. The -1H version of this device operates up to 133MHz frequency and has a higher drive than the -1 device. All parts have on-chip PLLs which lock to an input clock on the REF pin. The PLL feedback is on-chip and is obtained from the CLKOUT pad. In the absence of an input clock, the 2305 enters power down. In this mode, the device draws less than 25µA, the outputs are tri-stated, and the PLL is not running, resulting in a significant reduction of power.

The 2305 is characterized for both industrial and commercial operation.

Features

- Phase-Lock Loop clock distribution
- 10MHz to 133MHz operating frequency
- Distributes one clock input to one bank of five outputs
- Zero input-output delay
- Output skew < 250ps
- Low jitter < 200ps cycle-to-cycle
- 2305-1 for Standard drive
- 2305-1H for High drive
- No external RC network required
- Operates at 3.3V VDD
- Power-down mode
- Available in SOIC/TSSOP packages

Applications

- SDRAM
- Telecom
- Datacom
- PC Motherboards/Workstations
- Critical Path Delay designs

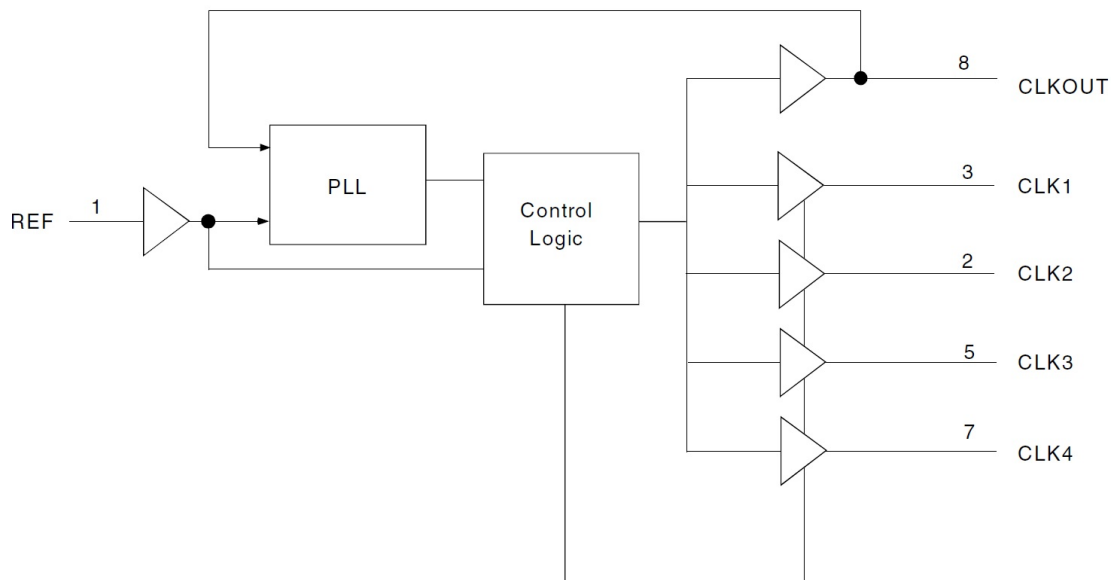

Figure 1. 2305 Functional Block Diagram

Contents

1. Pin Information	3
1.1 Pin Assignments	3
1.2 Pin Descriptions	3
2. Specifications	4
2.1 Absolute Maximum Ratings	4
2.2 Recommended Operating Conditions	4
2.3 Electrical Specifications– Commercial	5
2.4 Electrical Specifications – Industrial	6
3. Zero-Delay and Skew Control	8
4. Switching Waveforms	9
5. Test Circuits	9
6. Typical Duty Cycle and IDD Trends for 2305-1	10
7. Typical Duty Cycle and IDD Trends for 2305-1H	11
8. Package Outline Drawings	13
9. Ordering Information	13
10. Revision History	13

1. Pin Information

1.1 Pin Assignments

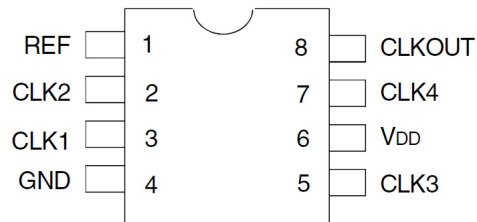

Figure 2. Pin Assignments – Top View

1.2 Pin Descriptions

Pin Number	Pin Name	Pin Type	Description
1	REF	In	Input reference clock, 5 Volt tolerant input.
2	CLK2 ^[1]	Out	Output clock.
3	CLK1 ^[1]	Out	Output clock.
4	GND	Ground	Ground.
5	CLK3 ^[1]	Out	Output clock.
6	VDD	Power	3.3V supply.
7	CLK4 ^[1]	Out	Output clock.
8	CLKOUT ^[1]	Out	Output clock, internal feedback on this pin.

1. Weak pull-down on all outputs.

2. Specifications

2.1 Absolute Maximum Ratings

Caution: Do not operate at or near the maximum ratings listed for extended periods of time. Exposure to such conditions can adversely impact product reliability and result in failures not covered by warranty.

Parameter	Maximum	Unit
Supply Voltage Range, V_{DD}	-0.5 to +4.6	V
Input Voltage Range (REF), V_I [1]	-0.5 to +5.5	V
Input Voltage Range (except REF), V_I	-0.5 to $V_{DD}+0.5$	V
Input Clamp Current, I_{IK} ($V_I < 0$)	-50	mA
Continuous Output Current, I_O ($V_O = 0$ to V_{DD})	± 50	mA
Continuous Current, V_{DD} or GND	± 100	mA
Maximum Power Dissipation, $T_A = 55^\circ\text{C}$ (in still air) ^[2]	0.7	W
Storage Temperature Range, T_{STG}	-65 to +150	$^\circ\text{C}$
Commercial Temperature Range	0 to +70	$^\circ\text{C}$
Industrial Temperature Range	-40 to +85	$^\circ\text{C}$

1. The input and output negative-voltage ratings may be exceeded if the input and output clamp-current ratings are observed.
2. The maximum package power dissipation is calculated using a junction temperature of 150°C and a board trace length of 750 mils.

2.2 Recommended Operating Conditions

Table 1. Recommended Operating Conditions – Commercial

Parameter	Minimum	Maximum	Unit
Supply Voltage, V_{DD}	3	3.6	V
Operating Temperature (ambient temperature), T_A	0	+70	$^\circ\text{C}$
Load Capacitance < 100MHz, C_L	-	30	pF
Load Capacitance 100MHz – 133MHz, C_L	-	10	
Input Capacitance, C_{IN}	-	7	pF

Table 2. Recommended Operating Conditions – Industrial

Parameter	Minimum	Maximum	Unit
Supply Voltage, V_{DD}	3	3.6	V
Operating Temperature (ambient temperature), T_A	-40	+85	$^\circ\text{C}$
Load Capacitance < 100MHz, C_L	-	30	pF
Load Capacitance 100MHz – 133MHz, C_L	-	10	
Input Capacitance, C_{IN}	-	7	pF

2.3 Electrical Specifications– Commercial

Table 3. DC Electrical Characteristics – Commercial

Parameter	Symbol	Conditions	Minimum	Maximum	Unit	
Input LOW Voltage Level	V_{IL}	-	-	0.8	V	
Input HIGH Voltage Level	V_{IH}	-	2	-	V	
Input LOW Current	I_{IL}	$V_{IN} = 0V$	-	50	μA	
Input HIGH Current	I_{IH}	$V_{IN} = V_{DD}$	-	100	μA	
Output LOW Voltage	V_{OL}	Standard drive	$I_{OL} = 8mA$	-	0.4	V
		High drive	$I_{OL} = 12mA (-1H)$			
Output HIGH Voltage	V_{OH}	Standard drive	$I_{OH} = -8mA$	2.4	-	V
		High drive	$I_{OH} = -12mA (-1H)$			
Power Down Current	I_{DD_PD}	REF = 0MHz	-	12	μA	
Supply Current	I_{DD}	Unloaded outputs at 66.66MHz	-	32	mA	

Table 4. Switching Characteristics (2305-1) – Commercial [1][2]

Parameter	Symbol	Conditions	Minimum	Typical	Maximum	Unit
Output Frequency	t1	10pF Load	10	-	133	MHz
		30pF Load	10	-	100	
Duty Cycle = $t_2 \div t_1$	-	Measured at 1.4V, $F_{OUT} = 66.66MHz$	40	50	60	%
Rise Time	t3	Measured between 0.8V and 2V	-	-	2.5	ns
Fall Time	t4	Measured between 0.8V and 2V	-	-	2.5	ns
Output to Output Skew	t5	All outputs equally loaded	-	-	250	ps
Delay, REF Rising Edge to CLKOUT Rising Edge	t6	Measured at $V_{DD}/2$	-	0	± 350	ps
Device-to-Device Skew	t7	Measured at $V_{DD}/2$ on the CLKOUT pins of devices	-	0	700	ps
Cycle-to-Cycle Jitter, peak–peak	t_j	Measured at 66.66MHz, loaded outputs	-	-	200	ps
PLL Lock Time	t_{LOCK}	Stable power supply, valid clock presented on REF pin	-	-	1	ms

1. REF Input has a threshold voltage of $V_{DD}/2$.
2. All parameters specified with loaded outputs.

Table 5. Switching Characteristics (2305-1H) – Commercial [1][2]

Parameter	Symbol	Conditions	Minimum	Typical	Maximum	Unit
Output Frequency	t1	10pF Load	10	-	133	MHz
		30pF Load	10	-	100	
Duty Cycle = t2 ÷ t1	-	Measured at 1.4V, F _{OUT} = 66.66MHz	40	50	60	%
Duty Cycle = t2 ÷ t1	-	Measured at 1.4V, F _{OUT} = 50MHz	45	50	55	%
Rise Time	t3	Measured between 0.8V and 2V	-	-	1.5	ns
Fall Time	t4	Measured between 0.8V and 2V	-	-	1.5	ns
Output to Output Skew	t5	All outputs equally loaded	-	-	250	ps
Delay, REF Rising Edge to CLKOUT Rising Edge	t6	Measured at V _{DD} /2	-	0	±350	ps
Device-to-Device Skew	t7	Measured at V _{DD} /2 on the CLKOUT pins of devices	-	0	700	ps
Output Slew Rate		Measured between 0.8V and 2V using Test Circuit #2	1	-	-	V/ns
Cycle-to-Cycle Jitter, peak-peak	t _J	Measured at 66.66MHz, loaded outputs	-	-	200	ps
PLL Lock Time	t _{LOCK}	Stable power supply, valid clock presented on REF pin	-	-	1	ms

1. REF Input has a threshold voltage of V_{DD}/2.
2. All parameters specified with loaded outputs.

2.4 Electrical Specifications – Industrial

Table 6. DC Electrical Characteristics – Industrial

Parameter	Symbol	Conditions	Minimum	Maximum	Unit
Input LOW Voltage Level	V _{IL}	-	-	0.8	V
Input HIGH Voltage Level	V _{IH}	-	2	-	V
Input LOW Current	I _{IL}	V _{IN} = 0V	-	50	μA
Input HIGH Current	I _{IH}	V _{IN} = V _{DD}	-	100	μA
Output LOW Voltage	V _{OL}	Standard drive	-	0.4	V
		High drive			
Output HIGH Voltage	V _{OH}	Standard drive	2.4	-	V
		High drive			
Power Down Current	I _{DD_PD}	REF = 0MHz	-	25	μA
Supply Current	I _{DD}	Unloaded outputs at 66.66MHz	-	35	mA

Table 7. Switching Characteristics (2305-1) – Industrial^{[1][2]}

Parameter	Symbol	Conditions	Minimum	Typical	Maximum	Unit
Output Frequency	t ₁	10pF Load	10	-	133	MHz
		30pF Load	10	-	100	
Duty Cycle = t ₂ ÷ t ₁	-	Measured at 1.4V, F _{OUT} = 66.66MHz	40	50	60	%
Rise Time	t ₃	Measured between 0.8V and 2V	-	-	2.5	ns
Fall Time	t ₄	Measured between 0.8V and 2V	-	-	2.5	ns
Output to Output Skew	t ₅	All outputs equally loaded	-	-	250	ps
Delay, REF Rising Edge to CLKOUT Rising Edge	t ₆	Measured at V _{DD} /2	-	0	±350	ps
Device-to-Device Skew	t ₇	Measured at V _{DD} /2 on the CLKOUT pins of devices	-	0	700	ps
Cycle-to-Cycle Jitter, peak-peak	t _J	Measured at 66.66MHz, loaded outputs	-	-	200	ps
PLL Lock Time	t _{LOCK}	Stable power supply, valid clock presented on REF pin	-	-	1	ms

1. REF Input has a threshold voltage of V_{DD}/2.
2. All parameters specified with loaded outputs.

Table 8. Switching Characteristics (2305-1H) – Industrial^{[1][2]}

Parameter	Symbol	Conditions	Minimum	Typical	Maximum	Unit
Output Frequency	t ₁	10pF Load	10	-	133	MHz
		30pF Load	10	-	100	
Duty Cycle = t ₂ ÷ t ₁	-	Measured at 1.4V, F _{OUT} = 66.66MHz	40	50	60	%
Duty Cycle = t ₂ ÷ t ₁	-	Measured at 1.4V, F _{OUT} = 50MHz	45	50	55	%
Rise Time	t ₃	Measured between 0.8V and 2V	-	-	1.5	ns
Fall Time	t ₄	Measured between 0.8V and 2V	-	-	1.5	ns
Output to Output Skew	t ₅	All outputs equally loaded	-	-	250	ps
Delay, REF Rising Edge to CLKOUT Rising Edge	t ₆	Measured at V _{DD} /2	-	0	±350	ps
Device-to-Device Skew	t ₇	Measured at V _{DD} /2 on the CLKOUT pins of devices	-	0	700	ps
Output Slew Rate		Measured between 0.8V and 2V using Test Circuit #2	1	-	-	V/ns
Cycle-to-Cycle Jitter, peak-peak	t _J	Measured at 66.66MHz, loaded outputs	-	-	200	ps
PLL Lock Time	t _{LOCK}	Stable power supply, valid clock presented on REF pin	-	-	1	ms

1. REF Input has a threshold voltage of V_{DD}/2.
2. All parameters specified with loaded outputs.

3. Zero-Delay and Skew Control

All outputs should be uniformly loaded in order to achieve Zero I/O Delay. Since the CLKOUT pin is the internal feedback for the PLL, its relative loading can affect and adjust the input/output delay. The Output Load Difference diagram illustrates the PLLs relative loading with respect to the other outputs that can adjust the Input-Output (I/O) Delay.

For designs utilizing zero I/O Delay, all outputs including CLKOUT must be equally loaded. Even if the output is not used, it must have a capacitive load equal to that on the other outputs in order to obtain true zero I/O Delay. If I/O Delay adjustments are needed, use the Output Load Difference diagram to calculate loading differences between the CLKOUT pin and other outputs. For zero output-to-output skew, all outputs must be loaded equally.

REF TO CLKA/CLKB RELAY vs. OUTPUT LOAD DIFFERENCE BETWEEN CLKOUT PIN AND CLKA/CLKB PINS

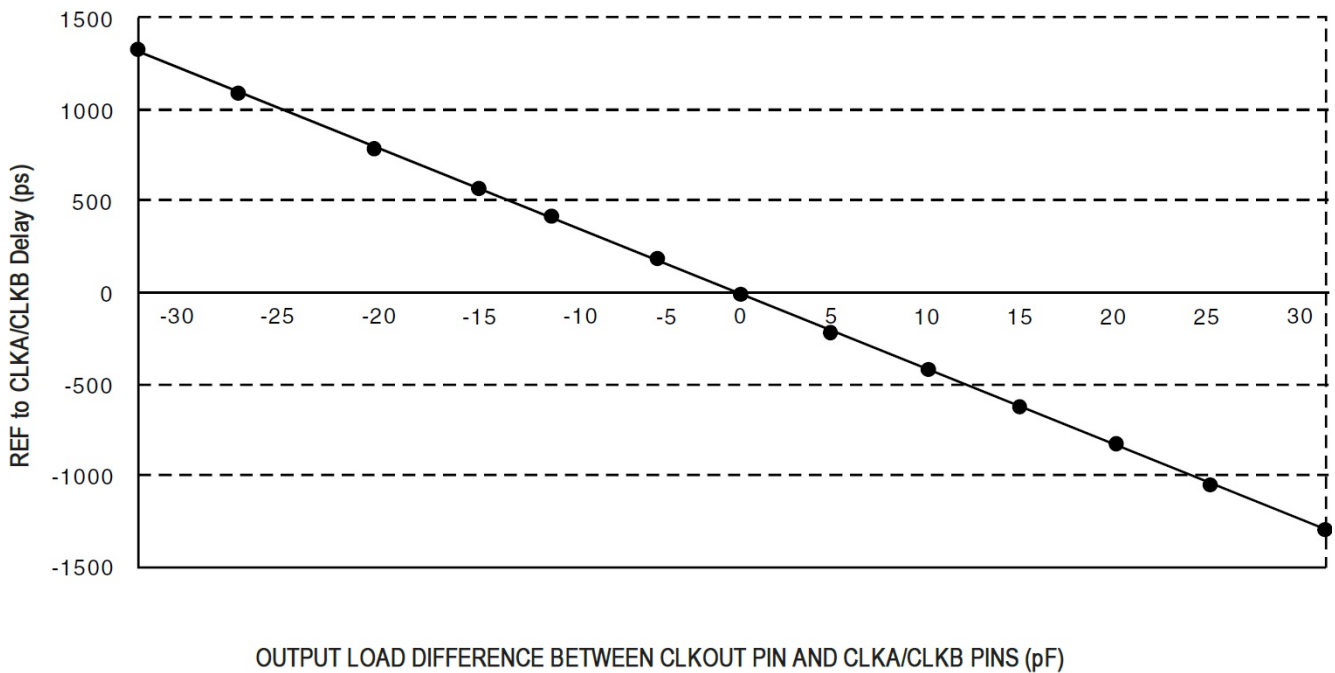

4. Switching Waveforms

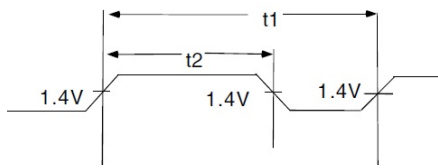

Figure 3. Duty Cycle Timing

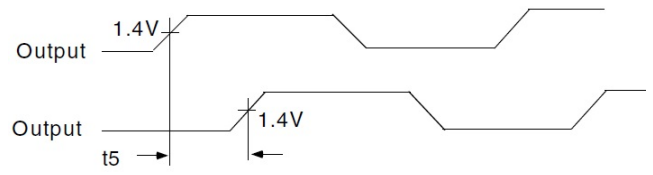

Figure 4. Output-to-Output Skew

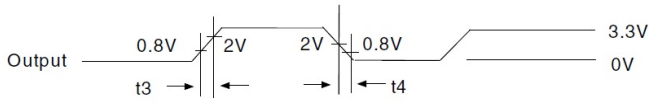

Figure 5. All Outputs Rise/Fall Time

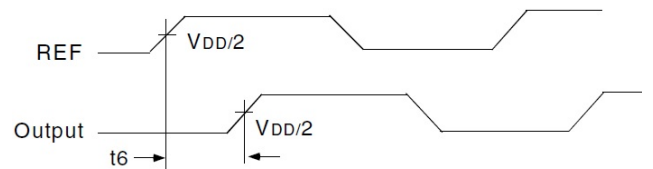

Figure 6. Input-to-Output Propagation Delay

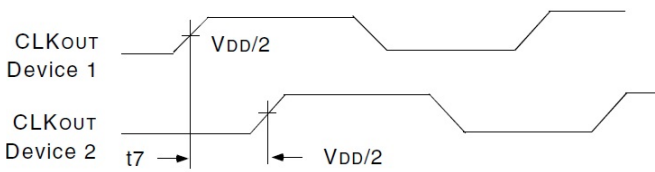

Figure 7. Device-to-Device Skew

5. Test Circuits

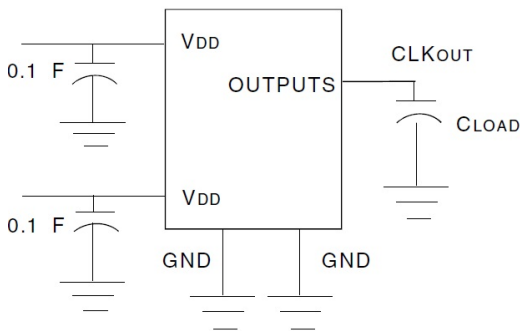

Figure 8. Test Circuit 1 (all parameters except t8)

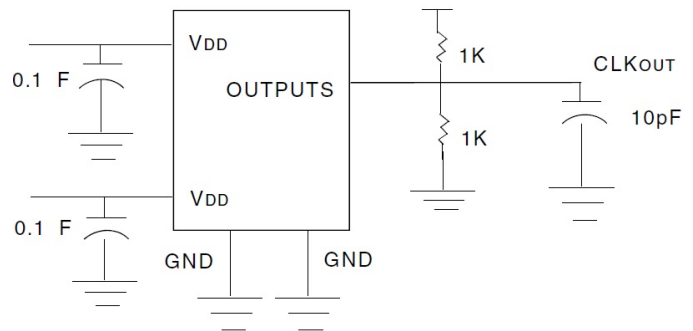

Figure 9. Test Circuit 2 (t8, Output Slew Rate on -1H devices)

6. Typical Duty Cycle and IDD Trends for 2305-1

- Duty cycle is taken from a typical chip measurement at 1.4V.
- I_{DD} data is calculated from $I_{DD} = I_{CORE} + nCVf$, where I_{CORE} is the unloaded current and where:
 n = Number of outputs; C = Capacitance load per output (F); V = Supply Voltage (V); f = Frequency (Hz).

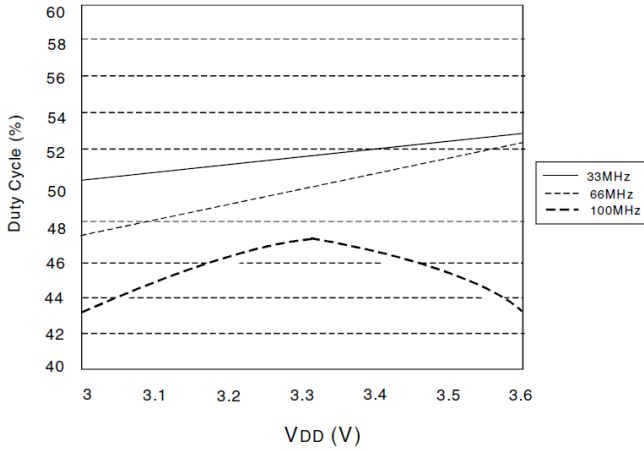

Figure 10. Duty Cycle vs VDD (30pF loads over frequency – 3.3V, 25°C)

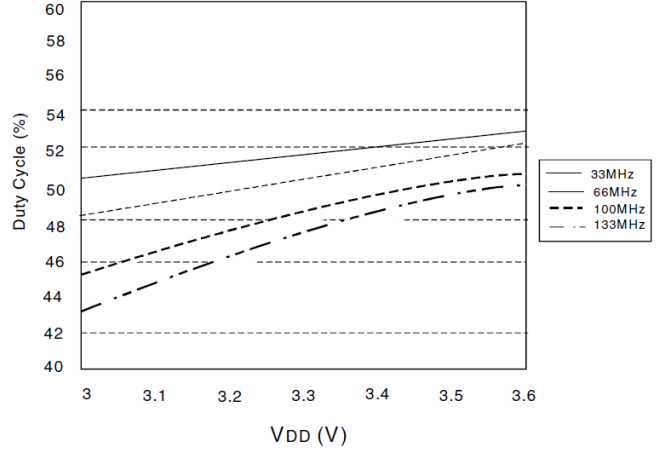

Figure 11. Duty Cycle vs VDD (10pF loads over frequency – 3.3V, 25°C)

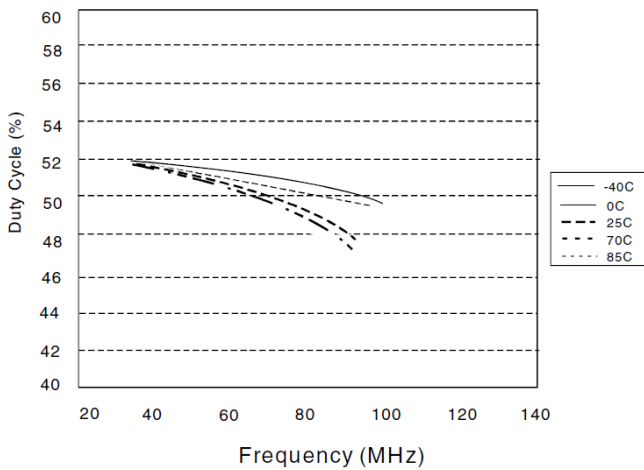

Figure 12. Duty Cycle vs Frequency (30pF loads over temperature – 3.3V)

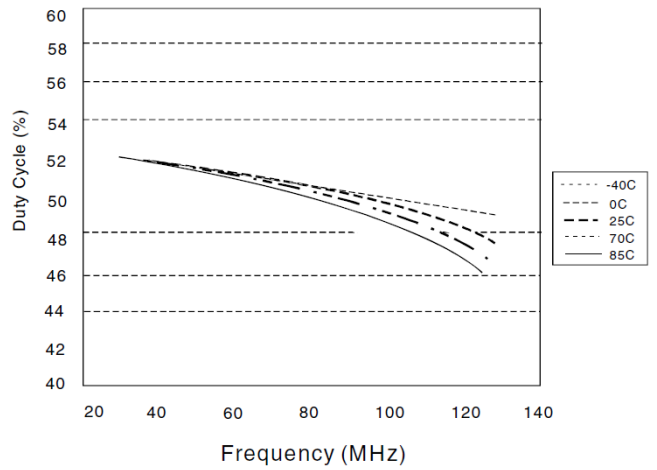

Figure 13. Duty Cycle vs Frequency (10pF loads over temperature – 3.3V)

- Duty cycle is taken from a typical chip measurement at 1.4V.
- I_{DD} data is calculated from $I_{DD} = I_{CORE} + nCVf$, where I_{CORE} is the unloaded current and where:
 n = Number of outputs; C = Capacitance load per output (F); V = Supply Voltage (V); f = Frequency (Hz).

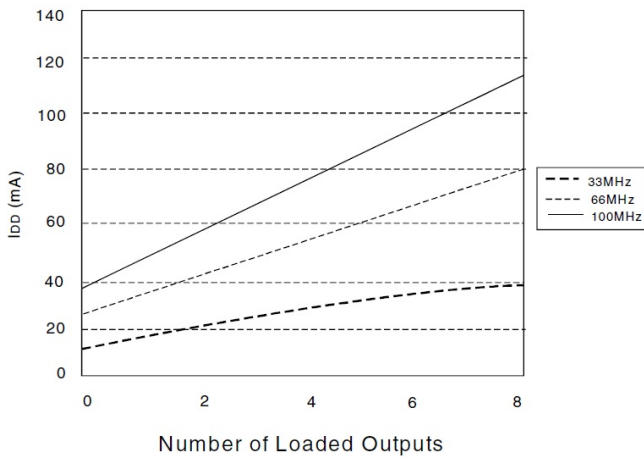

Figure 14. I_{DD} vs Number of Loaded Outputs (for 30pF loads over frequency – 3.3V, 25°C)

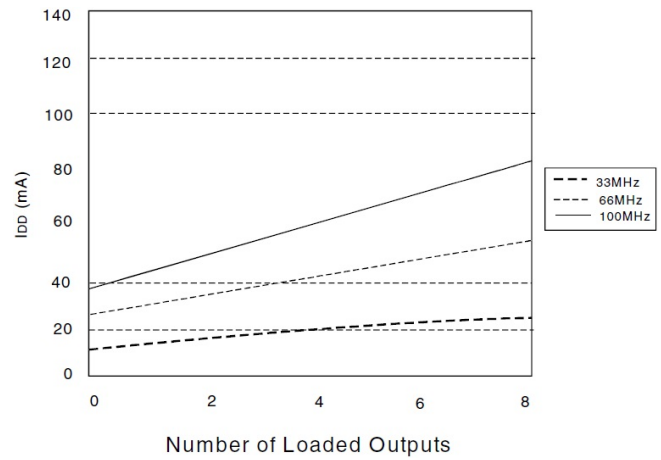

Figure 15. I_{DD} vs Number of Loaded Outputs (for 10pF loads over frequency – 3.3V, 25°C)

7. Typical Duty Cycle and I_{DD} Trends for 2305-1H

- Duty cycle is taken from a typical chip measurement at 1.4V.
- I_{DD} data is calculated from $I_{DD} = I_{CORE} + nCVf$, where I_{CORE} is the unloaded current and where:
 n = Number of outputs; C = Capacitance load per output (F); V = Supply Voltage (V); f = Frequency (Hz).

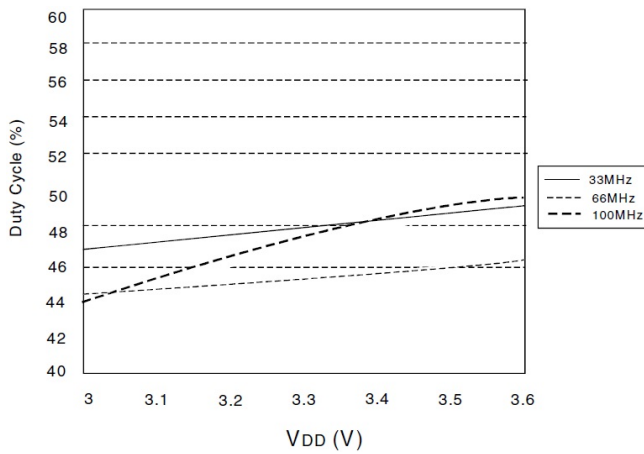

Figure 16. Duty Cycle vs V_{DD} (30pF loads over frequency – 3.3V, 25°C)

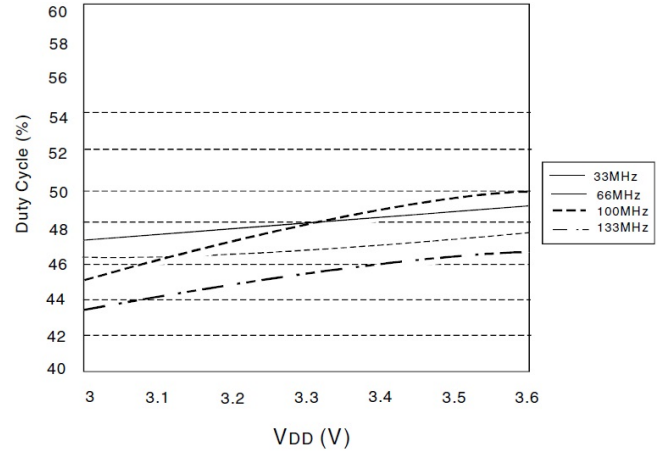

Figure 17. Duty Cycle vs V_{DD} (10pF loads over frequency – 3.3V, 25°C)

- Duty cycle is taken from a typical chip measurement at 1.4V.
- I_{DD} data is calculated from $I_{DD} = I_{CORE} + nCVf$, where I_{CORE} is the unloaded current and where:
 n = Number of outputs; C = Capacitance load per output (F); V = Supply Voltage (V); f = Frequency (Hz).

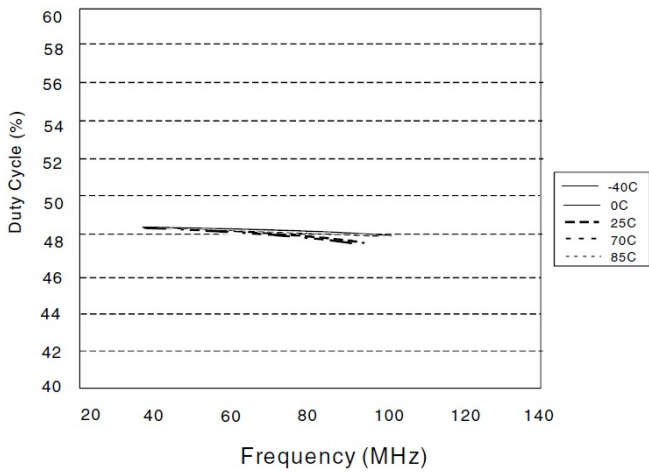

Figure 18. Duty Cycle vs Frequency (30pF loads over temperature - 3.3V)

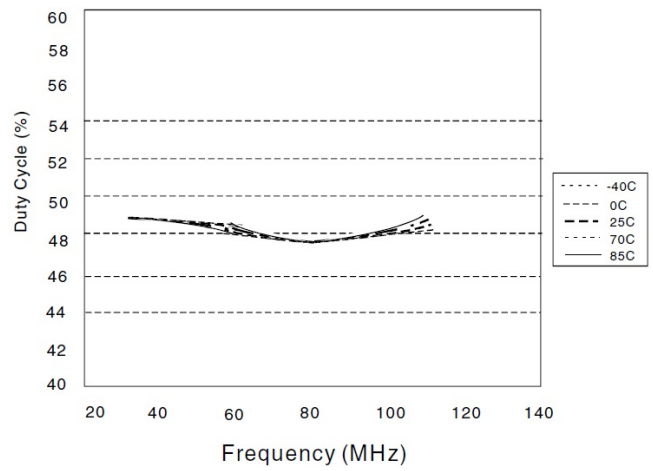

Figure 19. Duty Cycle vs Frequency (10pF loads over temperature - 3.3V)

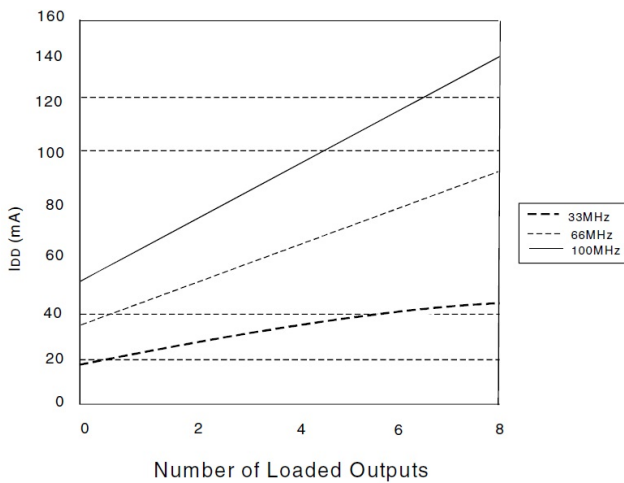

Figure 20. IDD vs Number of Loaded Outputs (for 30pF loads over frequency - 3.3V, 25°C)

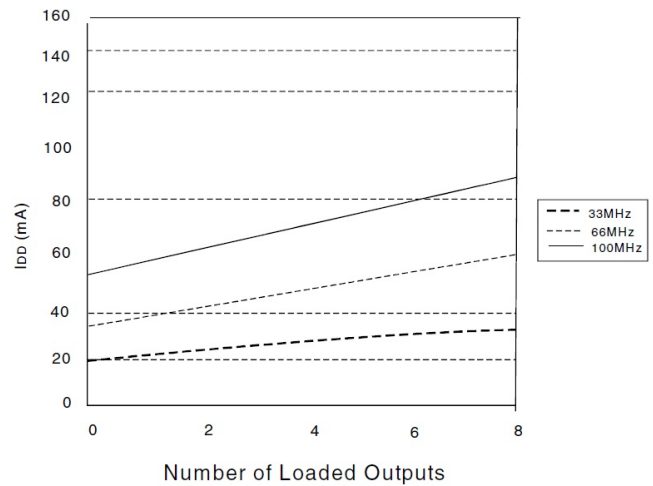

Figure 21. IDD vs Number of Loaded Outputs (for 10pF loads over frequency - 3.3V, 25°C)

8. Package Outline Drawings

The package outline drawings are located at the end of this document and are accessible from the Renesas website. The package information is the most current data available and is subject to change without revision of this document.

9. Ordering Information

Part Number	Package Description	Carrier Type	Temperature Range
2305-1DCG8 ^[1]	8-SOIC, 0.150" body, 0.050" pitch	Tape and Reel	0 to +70°C
2305-1DCG		Tray	
2305-1DCGI8 ^[1]	8-SOIC, 0.150" body, 0.050" pitch	Tape and Reel	-40 to +85°C
2305-1DCGI		Tray	
2305-1HDCG8 ^[1]	8-SOIC, 0.150" body, 0.050" pitch	Tape and Reel	0 to +70°C
2305-1HDCG		Tray	
2305-1HDCGI8 ^[1]	8-SOIC, 0.150" body, 0.050" pitch	Tape and Reel	-40 to +85°C
2305-1HDCGI		Tray	
2305-1PGGI	8-TSSOP, 4.4 × 3.0 mm, 0.65mm pitch	Tray	-40 to +85°C
2305-1PGG		Tray	0 to +70°C

1. 3000 pieces per reel in tape and reel form.
2. G = lead-free, RoHS compliant.

10. Revision History

Revision	Date	Description
1.00	Jan 7, 2025	<ul style="list-style-type: none"> Reformatted to the latest Renesas template. Updated Package Outline Drawings section and added links to PODs in Ordering Information. Added note for tape and reel quantity after Ordering Information.
-	Aug 16, 2012	Previous released version of datasheet.

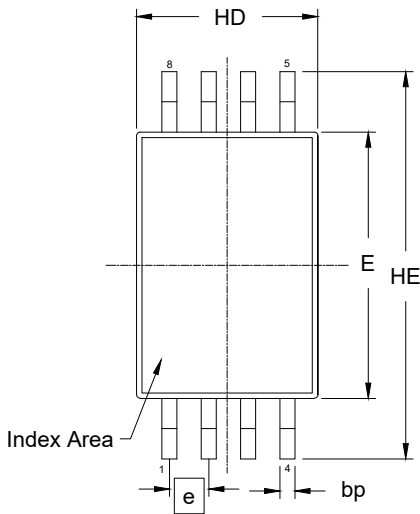

TOP VIEW

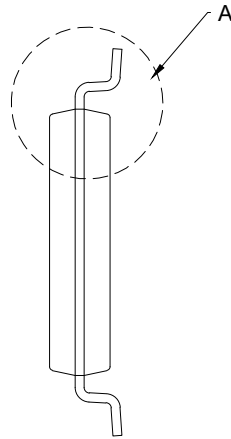

SIDE VIEW

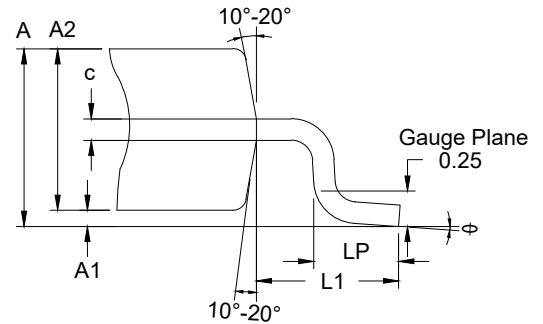

Detail A
(Rotated 90° CW)

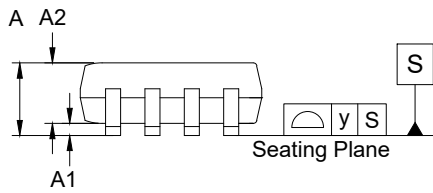

SIDE VIEW

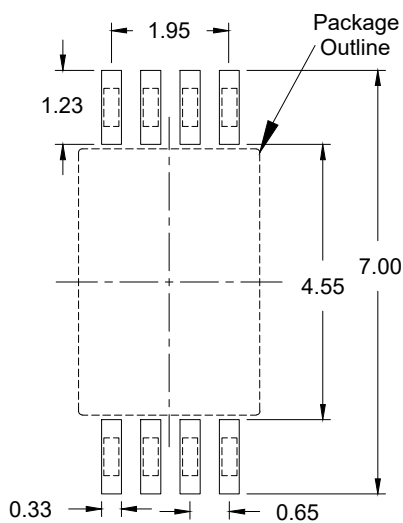

RECOMMENDED LAND PATTERN
(PCB Top View, SMD Design)

Reference Symbol	Dimension in mm		
	Min	Nom	Max
E	4.30	4.40	4.50
A2	0.80	-	1.05
HD	2.90	3.00	3.10
HE	6.20	6.40	6.60
A	0.85	-	1.20
A1	0.05	0.10	0.15
bp	0.19	0.25	0.30
c	0.09	-	0.20
θ	0.00	-	8.00
e	0.65 BSC		
y	-	-	0.10
LP	0.50	0.625	0.75
L1	-	1.00	-

NOTES:

1. JEDEC compatible.
2. All dimensions are in mm and angles are in degrees.
3. Use ± 0.05 mm for the non-toleranced dimensions.
4. Foot length is measured at gauge plane 0.25 mm above seating plane.

IMPORTANT NOTICE AND DISCLAIMER

RENESAS ELECTRONICS CORPORATION AND ITS SUBSIDIARIES (“RENESAS”) PROVIDES TECHNICAL SPECIFICATIONS AND RELIABILITY DATA (INCLUDING DATASHEETS), DESIGN RESOURCES (INCLUDING REFERENCE DESIGNS), APPLICATION OR OTHER DESIGN ADVICE, WEB TOOLS, SAFETY INFORMATION, AND OTHER RESOURCES “AS IS” AND WITH ALL FAULTS, AND DISCLAIMS ALL WARRANTIES, EXPRESS OR IMPLIED, INCLUDING, WITHOUT LIMITATION, ANY IMPLIED WARRANTIES OF MERCHANTABILITY, FITNESS FOR A PARTICULAR PURPOSE, OR NON-INFRINGEMENT OF THIRD-PARTY INTELLECTUAL PROPERTY RIGHTS.

These resources are intended for developers who are designing with Renesas products. You are solely responsible for (1) selecting the appropriate products for your application, (2) designing, validating, and testing your application, and (3) ensuring your application meets applicable standards, and any other safety, security, or other requirements. These resources are subject to change without notice. Renesas grants you permission to use these resources only to develop an application that uses Renesas products. Other reproduction or use of these resources is strictly prohibited. No license is granted to any other Renesas intellectual property or to any third-party intellectual property. Renesas disclaims responsibility for, and you will fully indemnify Renesas and its representatives against, any claims, damages, costs, losses, or liabilities arising from your use of these resources. Renesas' products are provided only subject to Renesas' Terms and Conditions of Sale or other applicable terms agreed to in writing. No use of any Renesas resources expands or otherwise alters any applicable warranties or warranty disclaimers for these products.

(Disclaimer Rev.1.01)

Corporate Headquarters

TOYOSU FORESIA, 3-2-24 Toyosu,
Koto-ku, Tokyo 135-0061, Japan
www.renesas.com

Trademarks

Renesas and the Renesas logo are trademarks of Renesas Electronics Corporation. All trademarks and registered trademarks are the property of their respective owners.

Contact Information

For further information on a product, technology, the most up-to-date version of a document, or your nearest sales office, please visit www.renesas.com/contact-us/.