

## Data Sheet | Item Number: 260-158

2-conductor terminal strip; without push-buttons; with snap-in mounting feet; 8-pole; for plate thickness 0.6 - 1.2 mm; Fixing hole 3.5 mm Ø; 1.5 mm<sup>2</sup>; CAGE CLAMP®; gray

<https://www.wago.com/260-158>

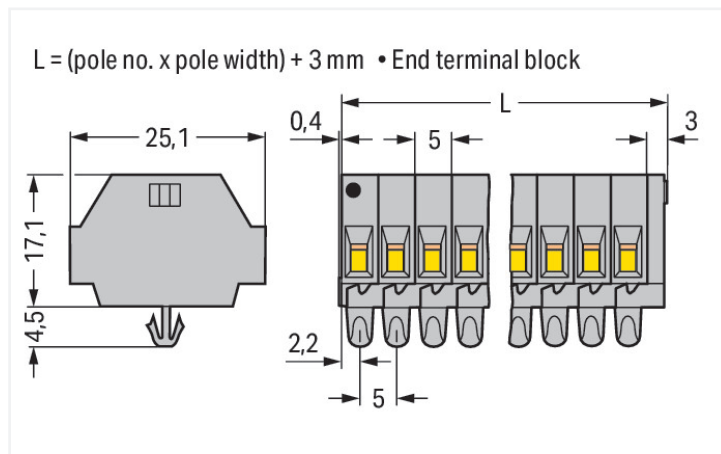
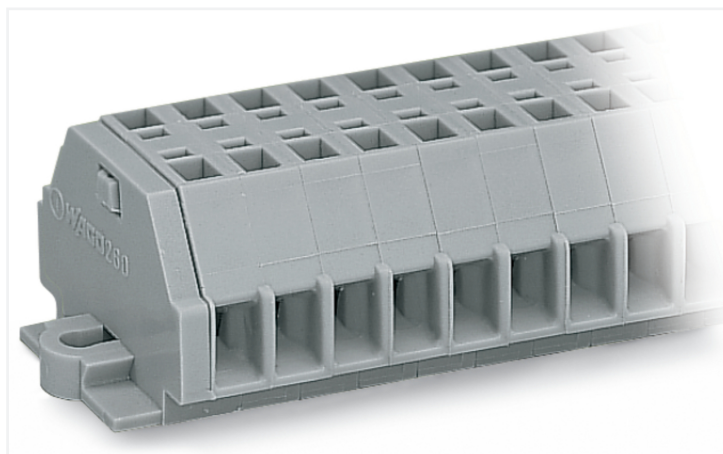

Color: ■ gray

Similar to illustration

Dimensions in mm

Through terminal block, 260 Series, gray

Connect conductors quickly and safely with this through terminal block (item number 260-158). Conductors should only be connected to this through terminal block if their strip length is between 8 and 9 mm. Whether for use in industry or building installations, our rail-mount through terminal blocks make it easy to quickly and securely connect electrical conductors. They're perfect for either classic through-wiring or distributing potential, depending on the variant. Featuring conductor terminals along with CAGE CLAMP®, this connector delivers reliable performance. Our tried-and-tested universal connection known as CAGE CLAMP® is industry-leading when it comes to connection technology and electrical interconnections. Dimensions: (43.4 x 25.1 x 21.5) mm (width x height x depth). Depending on the type of conductor, this through terminal block is suitable for conductor cross sections ranging from 0.08 mm<sup>2</sup> to 1.5 mm<sup>2</sup>.

This mini rail-mount terminal block is operated with an operating tool.

### Electrical data

#### Ratings per IEC/EN

Nominal voltage (III/3)	400 V
Rated impulse withstand voltage (III / 3)	6 kV
Rated current	18 A
Legend (ratings)	(III / 3) ≙ Overvoltage category III / Pollution degree 3

#### Approvals per

	UL 1059		
Use group	B	C	D
Rated voltage	300 V	300 V	600 V
Rated current	10 A	10 A	5 A

#### Approvals per

#### CSA 22.2 No 158

	B	C	D
Use group	B	C	D
Rated voltage	-	300 V	-
Rated current	-	10 A	-

#### General information

Wiring direction	Side-entry wiring
------------------	-------------------

### Connection Data

Clamping units	16
Total number of potentials	8
Number of levels	1

### Connection 1

Connection technology	CAGE CLAMP®
Actuation type	Operating tool
Connectable conductor materials	Copper
Solid conductor	0.08 ... 1.5 mm <sup>2</sup> / 28 ... 16 AWG
Fine-stranded conductor	0.08 ... 1.5 mm <sup>2</sup> / 28 ... 16 AWG
Strip length	8 ... 9 mm / 0.31 ... 0.35 inches
Pole number	8
Wiring direction	Side-entry wiring

### Physical data

Width	43.4 mm / 1.709 inches
Height	25.1 mm / 0.988 inches
Height from the surface	17.1 mm / 0.673 inches
Depth	21.5 mm / 0.846 inches
Module width	5 mm / 0.197 inches

### Mechanical data

Design	horizontal type
Mounting type	Snap-in foot
Marking level	Side marking

### Material data

Note (material data)	<a href="#">Information on material specifications can be found here</a>
Color	gray
Material group	I
Insulation material (main housing)	Polyamide (PA66)
Flammability class per UL94	V0
Fire load	0.25 MJ
Weight	13.8 g

### Environmental requirements

Processing temperature	-35 ... +85 °C
Continuous operating temperature	-60 ... +105 °C

### Commercial data

PU (SPU)	50 pcs
Packaging type	Box
Country of origin	DE
GTIN	4044918606950
Customs tariff number	85369010000

### Product Classification

UNSPSC	39121410
eCl@ss 10.0	27-14-11-06
eCl@ss 9.0	27-14-11-06
ETIM 9.0	EC001284
ETIM 10.0	EC001284
ECCN	NO US CLASSIFICATION

### Environmental Product Compliance

RoHS Compliance Status	Compliant, No Exemption
------------------------	-------------------------

### Approvals / Certificates

#### General approvals



Approval	Standard	Certificate Name
CCA DEKRA Certification B.V.	EN 60998	NTR-NL 6508
CCA DEKRA Certification B.V.	EN 60998	2110272.01
CSA DEKRA Certification B.V.	C22.2	70010891
UL Underwriters Laboratories Inc.	UL 1059	E45172

#### Declarations of conformity and manufacturer's declarations

Approval	Standard	Certificate Name
EU-Declaration of Conformity WAGO GmbH & Co. KG	-	-
UK-Declaration of Conformity WAGO GmbH & Co. KG	-	-

#### Approvals for marine applications



Approval	Standard	Certificate Name
ABS American Bureau of Shipping	-	24-0095979-PDA
BV Bureau Veritas S.A.	EN 60947	07436/G0 BV
LR Lloyds Register	IEC 60998	LR22173030TA
PRS Polski Rejestr Statków	-	TE/1094/880590/23

**Downloads**

**Environmental Product Compliance**

Compliance Search	
Environmental Product Compliance 260-158	↓

**Documentation**

Bid Text			
260-158	19.02.2019	xml 3.09 KB	↓
260-158	14.06.2017	doc 24.00 KB	↓

**CAD/CAE-Data**

CAD data
2D/3D Models 260-158

CAE data
EPLAN Data Portal 260-158
WSCAD Universe 260-158
ZUKEN Portal 260-158

**1 Compatible Products**

**1.1 Optional Accessories**

**1.1.1 DIN-rail**

**1.1.1.1 Mounting accessories**



**Item No.: 210-154**  
Aluminum carrier rail; 1000 mm long; 18 mm wide; 7 mm high; silver-colored

**1.1.2 Ferrule**

**1.1.2.1 Ferrule**



**Item No.: 216-301**  
Ferrule; Sleeve for 0.25 mm<sup>2</sup> / AWG 24; insulated; electro-tin plated; yellow



**Item No.: 216-302**  
Ferrule; Sleeve for 0.34 mm<sup>2</sup> / 22 AWG; insulated; electro-tin plated; light turquoise



**Item No.: 216-201**  
Ferrule; Sleeve for 0.5 mm<sup>2</sup> / 20 AWG; insulated; electro-tin plated; electrolytic copper; acc. to DIN 46228, Part 4/09.90; white



**Item No.: 216-101**  
Ferrule; Sleeve for 0.5 mm<sup>2</sup> / AWG 22; un-insulated; electro-tin plated; silver-colored



**Item No.: 216-202**  
Ferrule; Sleeve for 0.75 mm<sup>2</sup> / 18 AWG; insulated; electro-tin plated; gray



**Item No.: 216-102**  
Ferrule; Sleeve for 0.75 mm<sup>2</sup> / 18 AWG; un-insulated; electro-tin plated; silver-colored



**Item No.: 216-203**  
Ferrule; Sleeve for 1 mm<sup>2</sup> / AWG 18; insulated; electro-tin plated; red



**Item No.: 216-103**  
Ferrule; Sleeve for 1 mm<sup>2</sup> / AWG 18; un-insulated; electro-tin plated

### 1.1.2.1 Ferrule



**Item No.: 216-204**

Ferrule; Sleeve for 1.5 mm<sup>2</sup> / AWG 16; insulated; electro-tin plated; black

**Item No.: 216-104**

Ferrule; Sleeve for 1.5 mm<sup>2</sup> / AWG 16; uninsulated; electro-tin plated; silver-colored

### 1.1.3 Installation

#### 1.1.3.1 Mounting accessories



**Item No.: 209-137**

Mounting adapter; can be used as end stop; 6.5 mm wide; gray

**Item No.: 209-120**

Mounting foot; can be snapped on terminal blocks with snap-in mounting foot; for mounting on relay-modules; 6.4 mm wide; gray

### 1.1.4 Jumper

#### 1.1.4.1 Jumper



**Item No.: 260-402**

Jumper; for conductor entry; 2-way; insulated; gray

### 1.1.5 Marking

#### 1.1.5.1 Marking strip



**Item No.: 210-833**

Marking strips; 25 m on roll; 6 mm wide; plain; Self-adhesive; white

### 1.1.6 Test and measurement

#### 1.1.6.1 Testing accessories



**Item No.: 260-404**

Test plug module; with locking latches; modular; for 2-conductor terminal blocks; for 260 Series; gray

**Item No.: 249-135**

Test plug module; without locking device; modular; for 2-conductor terminal blocks; gray

**1.1.7 Tool**

**1.1.7.1 Operating tool**



**Item No.: 210-658**

Operating tool; Blade: 3.5 x 0.5 mm; with a partially insulated shaft; angled; short; multi-coloured

**Item No.: 210-720**

Operating tool; Blade: 3.5 x 0.5 mm; with a partially insulated shaft; multicoloured

**Item No.: 210-657**

Operating tool; Blade: 3.5 x 0.5 mm; with a partially insulated shaft; short; multicoloured

**Installation Notes**

**Conductor termination**

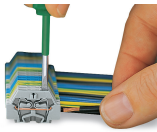

**CAGE CLAMP® connection**

Inserting a conductor.  
With ferruled conductors, it is necessary to use a terminal block one size larger than the conductor's nominal cross-section.

**Commoning**

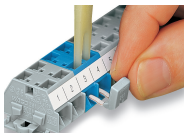

Commoning with comb-style jumper bar.

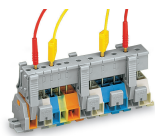

Testing via test plug modules snapped onto a terminal strip – wired or unwired. As touch contact is made with the CAGE CLAMP® (spring steel) unit, this testing type is limited to maximum 0.5 A.

Distance between locking devices must be approximately 35 ... 40 mm!

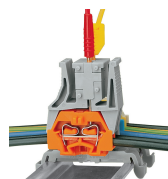

Testing after the conductors have been terminated.

**Installation**



Mounting a terminal strip with snap-in feet into holes.



Mounting a terminal strip with snap-in feet onto aluminum rail.



Terminal strip with snap-in mounting feet  
Snapping a mounting foot (209-120).  
(Distance between mounting feet: approx. 25 ... 30 mm)

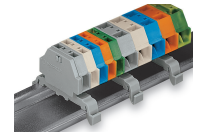

Terminal strip; with snap-in mounting feet; for DIN-35 rail



Terminal strip with snap-in mounting feet, for 0.6 ... 1.2 mm plate thickness, 3.5 mm mounting hole diameter (also for 210-154 Aluminum Rail or with 209-120 Mounting Foot for DIN-35 rail)

**Marking**



Marking with self-adhesive marking strips.



Marking by direct printing (upon request).