

## Data Sheet | Item Number: 256-510

PCB terminal block; push-button; 2.5 mm<sup>2</sup>; Pin spacing 7.5/7.62 mm; 10-pole; CAGE CLAMP®; commoning option; gray

<https://www.wago.com/256-510>

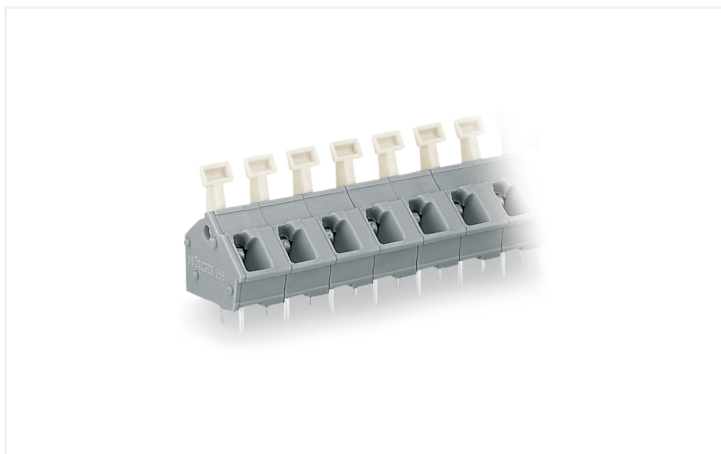

Color: ■ gray

Similar to illustration

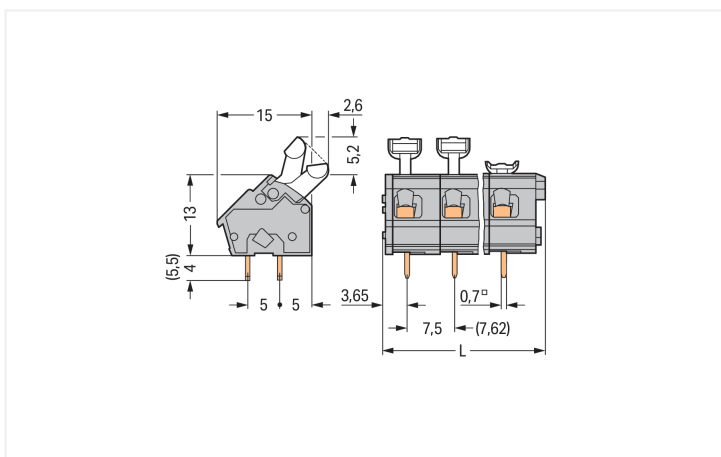
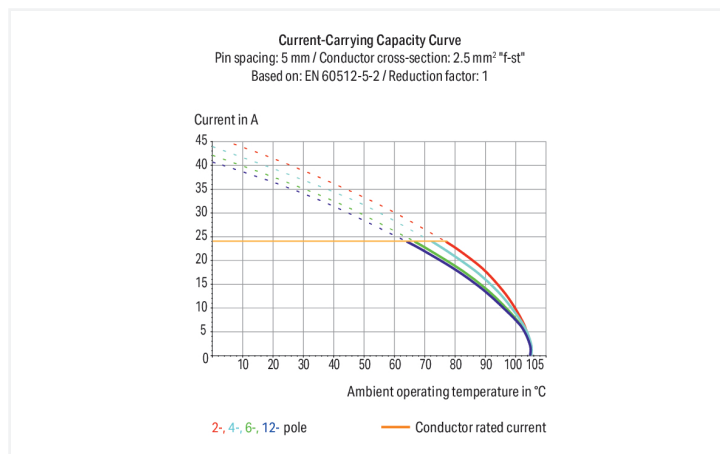

Dimensions in mm

L = (pole no. x pin spacing) + 2.9 mm

PCB terminal block, 256 Series, with 7.5 mm pin spacing

Our PCB terminal block (item number 256-510) is designed for seamless electrical installations. It is a universal connector that can be used practically anywhere, for example, as a pluggable PCB connector, panel feedthrough header, connector for rail-mount terminal blocks, or a floating connector for different mounting methods. Ensure that the strip lengths are between 5 and 6 mm when connecting conductors to this PCB terminal block. This product features one conductor terminal and utilizes CAGE CLAMP®. Our CAGE CLAMP® connection offers a convenient and maintenance-free way to connect all types of conductors. You do not need to prepare the conductor in any way, such as crimping ferrules. Dimensions: (77.9 x 22.2 x 17.6) mm (width x height x depth). Depending on the type of conductor, this PCB terminal block is suitable for conductor cross sections ranging from 0.08 mm<sup>2</sup> to 2.5 mm<sup>2</sup>.

Tin is used for coating the contact surfaces. A push-button is used to operate this PCB terminal block. THT is used to assemble the PCB terminal block. The conductor is designed to be inserted at a 45° angle.

## Notes

Variants:	Other pole numbers Versions for Ex e II and Ex i Other colors Mixed-color PCB connector strips Direct marking Other versions (or variants) can be requested from WAGO Sales or configured at <a href="https://configurator.wago.com/">https://configurator.wago.com/</a> .
-----------	---

## Electrical data

Ratings per	IEC/EN 60664-1		
Overvoltage category	III	III	II
Pollution degree	3	2	2
Nominal voltage	320 V	320 V	630 V
Rated impulse withstand voltage	4 kV	4 kV	4 kV
Rated current	24 A	24 A	24 A

Approvals per	UL 1059		
Use group	B	C	D
Rated voltage	300 V	-	300 V
Rated current	15 A	-	10 A

Approvals per	CSA		
Use group	B	C	D
Rated voltage	300 V	-	300 V
Rated current	15 A	-	10 A

## Connection Data

Clamping units	10
Total number of potentials	10
Number of connection types	1
Number of levels	1

Connection 1	
Connection technology	CAGE CLAMP®
Actuation type	Push-button
Solid conductor	0.08 ... 2.5 mm <sup>2</sup> / 28 ... 12 AWG
Fine-stranded conductor	0.08 ... 2.5 mm <sup>2</sup> / 28 ... 12 AWG
Fine-stranded conductor; with insulated ferrule	0.25 ... 1.5 mm <sup>2</sup>
Fine-stranded conductor; with uninsulated ferrule	0.25 ... 1.5 mm <sup>2</sup>
Note (conductor cross-section)	12 AWG: THHN, THWN
Strip length	5 ... 6 mm / 0.2 ... 0.24 inches
Conductor connection direction to PCB	45°
Pole number	10

## Physical data

Pin spacing	7.5/7.62 mm / 0.295/0.3 inches
Width	77.9 mm / 3.067 inches
Height	22.2 mm / 0.874 inches
Height from the surface	18.2 mm / 0.717 inches
Depth	17.6 mm / 0.693 inches
Solder pin length	4 mm
Solder pin dimensions	0.7 x 0.7 mm
!	1.1 <sup>(+0.1)</sup> mm

### PCB contact

PCB contact	THT
Solder pin arrangement	over the entire terminal strip (in-line)
Number of solder pins per potential	2

### Material data

Note (material data)	<a href="#">Information on material specifications can be found here</a>
Color	gray
Material group	I
Insulation material (main housing)	Polyamide (PA66)
Flammability class per UL94	V0
Clamping spring material	Chrome-nickel spring steel (CrNi)
Contact material	Electrolytic copper (E <sub>cu</sub> )
Contact Plating	Tin
Fire load	0.224 MJ
Weight	11.8 g

### Environmental requirements

Limit temperature range	-60 ... +105 °C
-------------------------	-----------------

### Commercial data

Product Group	4 (Printed Circuit Connectors)
PU (SPU)	60 (15) pcs
Packaging type	Box
Country of origin	CH
GTIN	4044918808774
Customs tariff number	85369010000

### Product Classification

UNSPSC	39121409
eCl@ss 10.0	27-44-04-01
eCl@ss 9.0	27-44-04-01
ETIM 9.0	EC002643
ETIM 10.0	EC002643
ECCN	NO US CLASSIFICATION

### Environmental Product Compliance

RoHS Compliance Status	Compliant, No Exemption
------------------------	-------------------------

### Approvals / Certificates

#### General approvals



Approval	Standard	Certificate Name
CCA DEKRA Certification B.V.	EN 60947	2160584.34
CCA DEKRA Certification B.V.	EN 60947	NTR NL-7138
CCA DEKRA Certification B.V.	IEC 60947-7-4	71-113042

#### General approvals

CSA DEKRA Certification B.V.	C22.2 No. 158	70049157
UL Underwriters Laboratories Inc.	UL 1059	20190731-E45172

Declarations of conformity and manufacturer's declarations

Approval	Standard	Certificate Name
EU-Declaration of Conformity WAGO GmbH & Co. KG	-	-
UK-Declaration of Conformity WAGO GmbH & Co. KG	-	-

Approvals for marine applications



Approval	Standard	Certificate Name
ABS American Bureau of Shipping	-	24-0095975-PDA
BV Bureau Veritas S.A.	IEC 60998	11915/E0 BV
DNV DNV GL SE	-	TAE000016Z
PRS Polski Rejestr Statków	-	TE/1095/880590/23

Downloads

Environmental Product Compliance

Compliance Search	
Environmental Product Compliance 256-510	<a href="#">↓</a>

Documentation

Additional Information			
Technical Section	03.04.2019	pdf 2027.26 KB	<a href="#">↓</a>
Gebrückte Klemmenleisten für Leiterplatten		pdf 303.71 KB	<a href="#">↓</a>

CAD/CAE-Data

CAD data	
2D/3D Models 256-510	<a href="#">↓</a>

CAE data	
EPLAN Data Portal 256-510	<a href="#">↓</a>
ZUKEN Portal 256-510	<a href="#">↓</a>

PCB Design

Symbol and Footprint via SamacSys 256-510	<a href="#">↓</a>
Symbol and Footprint via Ultra Librarian 256-510	<a href="#">↓</a>

1 Compatible Products

1.1 Optional Accessories

1.1.1 Ferrule

1.1.1.1 Ferrule

 <p><b>Item No.: 216-301</b> Ferrule; Sleeve for 0.25 mm<sup>2</sup> / AWG 24; insulated; electro-tin plated; yellow</p>	 <p><b>Item No.: 216-321</b> Ferrule; Sleeve for 0.25 mm<sup>2</sup> / AWG 24; insulated; electro-tin plated; yellow</p>	 <p><b>Item No.: 216-151</b> Ferrule; Sleeve for 0.25 mm<sup>2</sup> / AWG 24; uninsulated; electro-tin plated</p>	 <p><b>Item No.: 216-131</b> Ferrule; Sleeve for 0.25 mm<sup>2</sup> / AWG 24; uninsulated; electro-tin plated; silver-colored</p>
 <p><b>Item No.: 216-302</b> Ferrule; Sleeve for 0.34 mm<sup>2</sup> / 22 AWG; insulated; electro-tin plated; light turquoise</p>	 <p><b>Item No.: 216-322</b> Ferrule; Sleeve for 0.34 mm<sup>2</sup> / 22 AWG; insulated; electro-tin plated; light turquoise</p>	 <p><b>Item No.: 216-132</b> Ferrule; Sleeve for 0.34 mm<sup>2</sup> / AWG 24; uninsulated; electro-tin plated</p>	 <p><b>Item No.: 216-152</b> Ferrule; Sleeve for 0.34 mm<sup>2</sup> / AWG 24; uninsulated; electro-tin plated</p>
 <p><b>Item No.: 216-201</b> Ferrule; Sleeve for 0.5 mm<sup>2</sup> / 20 AWG; insulated; electro-tin plated; electrolytic copper; acc. to DIN 46228, Part 4/09.90; white</p>	 <p><b>Item No.: 216-241</b> Ferrule; Sleeve for 0.5 mm<sup>2</sup> / 20 AWG; insulated; electro-tin plated; electrolytic copper; gastight crimped; acc. to DIN 46228, Part 4/09.90; white</p>	 <p><b>Item No.: 216-221</b> Ferrule; Sleeve for 0.5 mm<sup>2</sup> / 20 AWG; insulated; electro-tin plated; white</p>	 <p><b>Item No.: 216-141</b> Ferrule; Sleeve for 0.5 mm<sup>2</sup> / 20 AWG; uninsulated; electro-tin plated; electrolytic copper; gastight crimped; acc. to DIN 46228, Part 1/08.92</p>
 <p><b>Item No.: 216-101</b> Ferrule; Sleeve for 0.5 mm<sup>2</sup> / AWG 22; uninsulated; electro-tin plated; silver-colored</p>	 <p><b>Item No.: 216-121</b> Ferrule; Sleeve for 0.5 mm<sup>2</sup> / AWG 22; uninsulated; electro-tin plated; silver-colored</p>	 <p><b>Item No.: 216-242</b> Ferrule; Sleeve for 0.75 mm<sup>2</sup> / 18 AWG; insulated; electro-tin plated; electrolytic copper; gastight crimped; acc. to DIN 46228, Part 4/09.90; gray</p>	 <p><b>Item No.: 216-262</b> Ferrule; Sleeve for 0.75 mm<sup>2</sup> / 18 AWG; insulated; electro-tin plated; electrolytic copper; gastight crimped; acc. to DIN 46228, Part 4/09.90; gray</p>
 <p><b>Item No.: 216-202</b> Ferrule; Sleeve for 0.75 mm<sup>2</sup> / 18 AWG; insulated; electro-tin plated; gray</p>	 <p><b>Item No.: 216-222</b> Ferrule; Sleeve for 0.75 mm<sup>2</sup> / 18 AWG; insulated; electro-tin plated; gray</p>	 <p><b>Item No.: 216-142</b> Ferrule; Sleeve for 0.75 mm<sup>2</sup> / 18 AWG; uninsulated; electro-tin plated; electrolytic copper; gastight crimped; acc. to DIN 46228, Part 1/08.92</p>	 <p><b>Item No.: 216-102</b> Ferrule; Sleeve for 0.75 mm<sup>2</sup> / AWG 20; uninsulated; electro-tin plated; silver-colored</p>
 <p><b>Item No.: 216-122</b> Ferrule; Sleeve for 0.75 mm<sup>2</sup> / AWG 20; uninsulated; electro-tin plated; silver-colored</p>	 <p><b>Item No.: 216-243</b> Ferrule; Sleeve for 1 mm<sup>2</sup> / AWG 18; insulated; electro-tin plated; electrolytic copper; gastight crimped; acc. to DIN 46228, Part 4/09.90; red</p>	 <p><b>Item No.: 216-263</b> Ferrule; Sleeve for 1 mm<sup>2</sup> / AWG 18; insulated; electro-tin plated; electrolytic copper; gastight crimped; acc. to DIN 46228, Part 4/09.90; red</p>	 <p><b>Item No.: 216-203</b> Ferrule; Sleeve for 1 mm<sup>2</sup> / AWG 18; insulated; electro-tin plated; red</p>
 <p><b>Item No.: 216-223</b> Ferrule; Sleeve for 1 mm<sup>2</sup> / AWG 18; insulated; electro-tin plated; red</p>	 <p><b>Item No.: 216-103</b> Ferrule; Sleeve for 1 mm<sup>2</sup> / AWG 18; uninsulated; electro-tin plated</p>	 <p><b>Item No.: 216-143</b> Ferrule; Sleeve for 1 mm<sup>2</sup> / AWG 18; uninsulated; electro-tin plated; electrolytic copper; gastight crimped; acc. to DIN 46228, Part 1/08.92</p>	 <p><b>Item No.: 216-123</b> Ferrule; Sleeve for 1 mm<sup>2</sup> / AWG 18; uninsulated; electro-tin plated; silver-colored</p>
 <p><b>Item No.: 216-204</b> Ferrule; Sleeve for 1.5 mm<sup>2</sup> / AWG 16; insulated; electro-tin plated; black</p>	 <p><b>Item No.: 216-224</b> Ferrule; Sleeve for 1.5 mm<sup>2</sup> / AWG 16; insulated; electro-tin plated; black</p>	 <p><b>Item No.: 216-244</b> Ferrule; Sleeve for 1.5 mm<sup>2</sup> / AWG 16; insulated; electro-tin plated; electrolytic copper; gastight crimped; acc. to DIN 46228, Part 4/09.90; black</p>	 <p><b>Item No.: 216-264</b> Ferrule; Sleeve for 1.5 mm<sup>2</sup> / AWG 16; insulated; electro-tin plated; electrolytic copper; gastight crimped; acc. to DIN 46228, Part 4/09.90; black</p>
 <p><b>Item No.: 216-284</b> Ferrule; Sleeve for 1.5 mm<sup>2</sup> / AWG 16; insulated; electro-tin plated; electrolytic copper; gastight crimped; acc. to DIN 46228, Part 4/09.90; black</p>	 <p><b>Item No.: 216-124</b> Ferrule; Sleeve for 1.5 mm<sup>2</sup> / AWG 16; uninsulated; electro-tin plated</p>	 <p><b>Item No.: 216-144</b> Ferrule; Sleeve for 1.5 mm<sup>2</sup> / AWG 16; uninsulated; electro-tin plated; electrolytic copper; gastight crimped; acc. to DIN 46228, Part 1/08.92; silver-colored</p>	 <p><b>Item No.: 216-104</b> Ferrule; Sleeve for 1.5 mm<sup>2</sup> / AWG 16; uninsulated; electro-tin plated; silver-colored</p>

### 1.1.2 Marking

#### 1.1.2.1 Marking strip



**Item No.: 210-332/750-020**

Marking strips; as a DIN A4 sheet; MARKED; 1-20 (80x); Height of marker strip: 3 mm; Strip length 182 mm; Horizontal marking; Self-adhesive; white



**Item No.: 210-332/762-020**

Marking strips; as a DIN A4 sheet; MARKED; 1-20 (80x); Height of marker strip: 3 mm; Strip length 182 mm; Horizontal marking; Self-adhesive; white

### 1.1.3 Test and measurement

#### 1.1.3.1 Testing accessories



**Item No.: 249-112**

Test plug adapter; suitable for 255, 256, 257 Series PCB terminal blocks; 1-pole; Pin spacing 7.5 mm / 0.295 in; gray



**Item No.: 249-113**

Test plug adapter; suitable for 255, 256, 257 Series PCB terminal blocks; 1-pole; Pin spacing 7.62 mm / 0.3 in; orange

### 1.1.4 Tool

#### 1.1.4.1 Operating tool



**Item No.: 210-658**

Operating tool; Blade: 3.5 x 0.5 mm; with a partially insulated shaft; angled; short; multicoloured



**Item No.: 210-720**

Operating tool; Blade: 3.5 x 0.5 mm; with a partially insulated shaft; multicoloured

## Installation Notes

### Conductor termination



Inserting/removing a conductor – 256 Series.

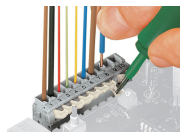

Inserting/removing a conductor (255 Series)

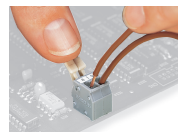

Inserting/removing a conductor via finger-operated lever – 255 Series.

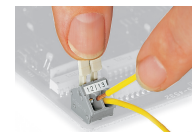

Inserting/removing a conductor via finger-operated lever – 256 Series.

## Installation



Possible conductor arrangement with terminal strips staggered (for 256 Series only).

## Marking



Formation of groups using housings of different colors

## Testing

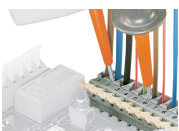

Testing with test probes.



Testing with test plug modules.