

T9A Series, DC Coil 30A PCB or Panel Mount Relay

- 30A switching in 1 form A (NO) and 20A in 1 form C (CO)
- Plastic sealed case available
- Meets UL 508 and 873 spacing - 3.18mm through air, 6.36mm over surface
- Option for load connections via 0.250" (6.35mm) Q.C. terminals
- UL class F insulation system standard

Typical applications
HVAC, Appliances, Industrial Controls

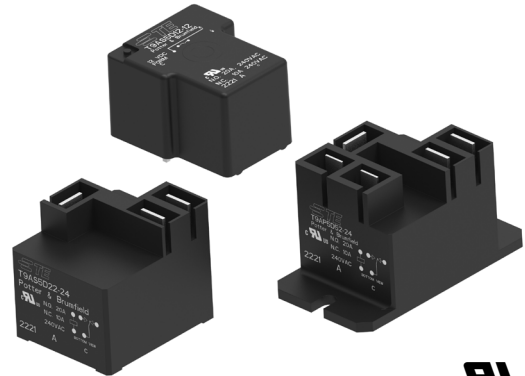

Approvals

UL E58304

Technical data of approved types on request

Contact Data

Contact arrangement	1 form A (NO), 1 form B (NC), 1 form C (CO)		
Rated voltage	277VAC		
Max. switching voltage	277VAC		
Rated current	30A	15A	20A/10A
Limiting continuous current	30A		
Contact material	AgSnInO, AgCdO		
Min. recommended contact load	1A, 5VDC or 12VAC		
Initial contact resistance	75 mΩ at 1A at 5VDC or 12VAC		
Frequency of operation, with/without load	360/3600hr		
Operate/release time max., including bounce	15/15ms		

Contact ratings ¹⁾

Type	Load	Cycles
------	------	--------

Factory

AgCdO, 1W coil		
NO	30A, 240VAC, general purpose	100x10 ³
NO	25A, 240VAC, resistive	100x10 ³
CO	20A/10A, 240VAC, general purpose	100x10 ³
CO	20A/10A, 240VAC, resistive	100x10 ³
CO	20A/10A, 28VDC, resistive	100x10 ³

UL 508/873

AgCdO, 1W coil		
NO	30A, 240VAC, general purpose	100x10 ³
NC	15A, 240VAC, general purpose	100x10 ³
CO	20A/10A, 240VAC, general purpose	100x10 ³
NC	20A, 240VAC, resistive	6x10 ³
CO	16.75A/13.4A, 240VAC, resistive	6x10 ³
NO	80LRA/30FLA, 240VAC	30x10 ³
NC	30LRA/12FLA, 240VAC	30x10 ³
CO	53.6LRA/20FLA / 20LRA/8FLA, 240VAC	30x10 ³
NO	98LRA/22FLA, 120VAC	100x10 ³
NO	2HP, 240VAC	1x10 ³
NC	1/2HP, 240VAC	1x10 ³
NO	1HP, 125VAC	1x10 ³
NC	1/4HP, 125VAC	1x10 ³
NO	10A, 277VAC, ballast	6x10 ³
NC	3A, 277VAC, ballast	6x10 ³
NO	8.3A, 120VAC, tungsten	6x10 ³
NO	5.4A, 277VAC, tungsten	6x10 ³
NO	470VA, 120VAC, pilot duty	30x10 ³
NO	20A, 28VDC, resistive	100x10 ³
NC	10A, 28VDC, resistive	100x10 ³

AgCdO - Enhanced Version Only, 1W coil

NO	21A, 250VAC, resistive	250x10 ³
NO	25A, 277VAC, resistive	100x10 ³

AgCdO, 1W coil ("H" type)

NO	25A, 240VAC, resistive, 105°C	6x10 ³
----	-------------------------------	-------------------

1) Contact ratings at 25°C (unless otherwise noted) with relay properly vented. Remove vent nib after soldering and cleaning.

Contact ratings ¹⁾ (continued)

Type	Load	Cycles
UL 508/873		
AgSnInO, 1W coil		
NO	30A, 240VAC, general purpose	100x10 ³
NO	80LRA/30FLA, 240VAC	30x10 ³
NC	10A, 250VAC, resistive	50x10 ³
AgCdO, 900mW coil		
NO	30A, 240VAC, general purpose	100x10 ³
NO	18A, 240VAC, resistive, 105°C	100x10 ³
NC	15A, 240VAC, resistive	6x10 ³
NO	30LRA/15FLA, 240VAC	100x10 ³
NO	50LRA/16FLA, 120VAC	100x10 ³
NO	30LRA/11FLA, 120VAC	200x10 ³

1) Contact ratings at 25°C (unless otherwise noted) with relay properly vented. Remove vent nib after soldering and cleaning.

Mechanical endurance	10x10 ⁶ ops.
----------------------	-------------------------

Coil Data

Coil voltage range	5 to 110VDC
Max. coil power	110% of nominal
Max. coil temperature	155°C
Coil insulation system according UL	Class F

Coil versions, DC coil

Coil code	Rated voltage VDC	Operate voltage VDC	Release voltage VDC	Coil resistance Ω±10%	Rated coil power W
Code D (1W) coil					
5	5	3.75	0.5	25	1
6	6	4.5	0.6	36	1
9	9	6.75	0.9	81	1
12	12	9	1.2	144	1
15	15	11.25	1.5	225	1
18	18	13.5	1.8	324	1
24	24	18	2.4	576	1
48	48	36	4.8	2304	1
110	110	82.5	11	12100	1
Code L (900mW) coil					
5	5	3.75	0.5	27	.9
6	6	4.5	0.6	40	.9
9	9	6.75	0.9	97	.9
12	12	9	1.2	155	.9
15	15	11.25	1.5	256	.9
18	18	13.5	1.8	380	.9
24	24	18	2.4	660	.9
48	48	36	4.8	2560	.9
110	110	82.5	11	13450	.9

All figures are given for coil without preenergization, at ambient temperature +23°C.

T9A Series, DC Coil 30A PCB or Panel Mount Relay (Continued)

Coil Data (continued)

Ambient temperature vs. coil voltage – 1W coil

Data below are average values and should be verified in application. Tests were conducted within a 2' (.6 m) cube (still air); at nominal coil power @ 25°C; with normally open contact loaded; and with 4' (1.22 m) long, #10 AWG load wires. P.C. board relays were mounted to a 30A, single side P.C. board. Coil rise test conducted with a 30A PC board to maintain 20°C max. rise at 30°C. The relay connections and wiring must be designed with an adequate cross section to ensure proper current flow and heat dissipation.

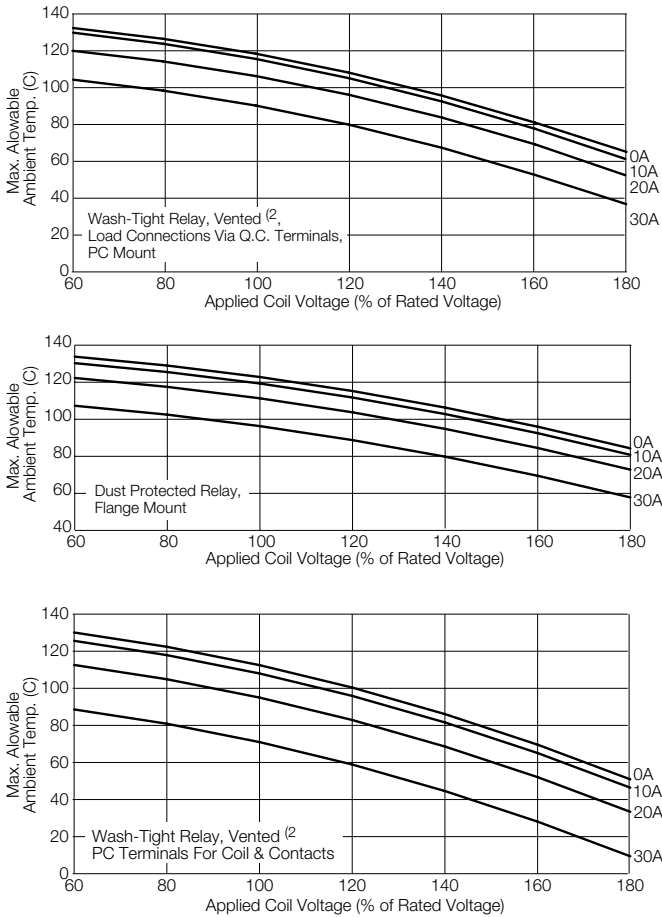

2) Remove knock-off nib after cleaning process for optimum life of wash-tight relays.

Dimensions

T9AS/V – Mounting and termination code 2

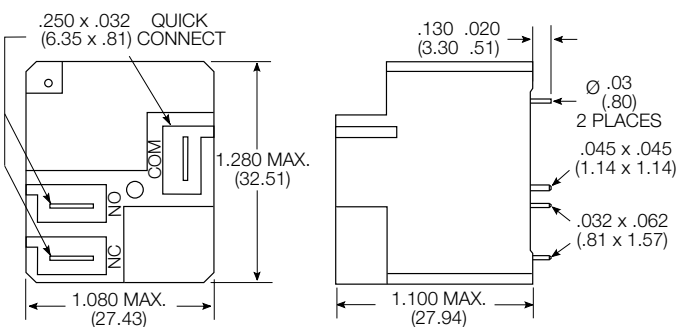

Insulation Data

Initial dielectric strength	
between open contacts	1500V _{rms}
between contact and coil	2500V _{rms}
Initial surge withstand voltage	
between contact and coil	6kV
Initial insulation resistance	
between insulated elements	1x10 ⁹ Ω
Clearance/creepage	
between contact and coil	3.18mm clearance/6.3638mm

Other Data

Material compliance: EU RoHS/ELV, China RoHS, REACH, Halogen content refer to the Product Compliance Support Center at www.te.com/customer-support/rohssupportcenter

Ambient temperature	
DC coil	-55°C to 85°C ³⁾
	105°C models available
Category of environmental protection	
IEC 61810	RT0 - open, RTI - dust protected, RTII - flux proof, RTIII - wash tight
Vibration resistance (functional)	1.65mm max excursions, 10-55 Hz
Shock resistance (functional)	10g for 11msec
Shock resistance (destructive)	100g
Terminal type	pcb-tht and pcb-tht + quick connect
Weight	26g mounting code 1 33g mounting codes 2 and 5

Resistance to soldering heat THT	
IEC 60068-2-20	250°C
Packaging/unit	tray/50 pcs., bundle/250 pcs., box/500 pcs.

3) Operating ambient temperature must consider "Must Operate Voltage Change Over Temperature," Contact Temperature Rise, Coil Temperature Rise (If coil is not allowed to cool) and Maximum Coil Temperature. Specification ambient considers 20A load with coil cooled to ambient.

T9AP – Mounting and termination code 5

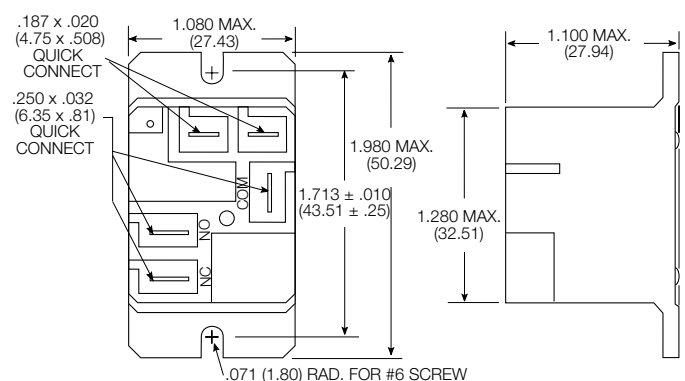

Note: Recommended mounting screw torque is 4.0-5.0 lbs.in when #6 screw is used.

T9A Series, DC Coil 30A PCB or Panel Mount Relay (Continued)

Dimensions

T9AS/V - Mounting and termination code 1

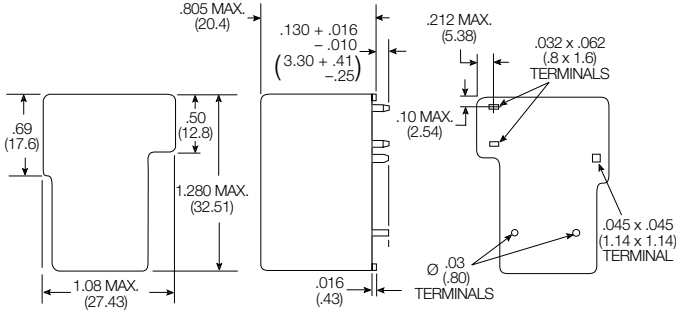

Terminal assignment

Bottom view on pins

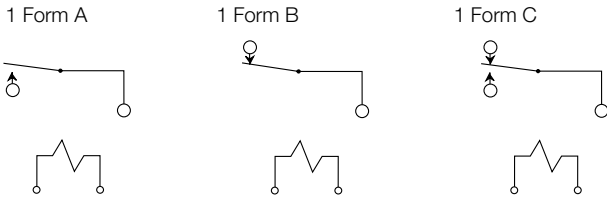

Notes:

1) General tolerance

Diagram Dimensions	Tolerance
<1mm	±0.1
1-3mm	±0.2
>3mm	±0.3

2) Dimensions of the pins after tin soldering for PCB type

- a) +0.2 for the width and thickness
- b) +0.5 for the length

PCB layout

Bottom view on pins

T9AS/V - Mounting and termination code 2

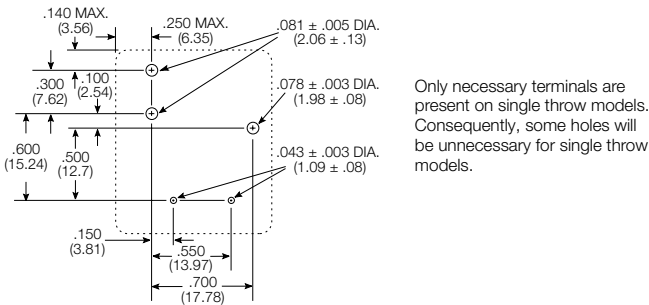

Only necessary terminals are present on single throw models. Consequently, some holes will be unnecessary for single throw models.

T9AS/V - Mounting and termination code 1

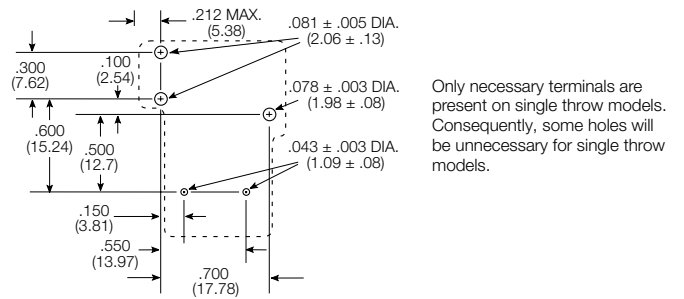

Only necessary terminals are present on single throw models. Consequently, some holes will be unnecessary for single throw models.

Product code structure

Typical product code **T9A S 5 D 2 2 -12**

Type	T9A Power PCB or panel mount relay T9A						
Enclosure	<ul style="list-style-type: none"> P Dust protected plastic case (requires mounting code 5) S Wash-tight plastic case with knock off nib¹⁾ (requires mounting code 1 or 2) V Flux-proof plastic case (requires mounting code 1 or 2) 						
Contact arrangement	1 1 form A (1 NO)	2 1 form B (1 NC)	5 1 form C (1 CO)				
Coil Input	D DC voltage, 1W	L DC voltage, 900mW	H²⁾ DC voltage, 1W (+0/-10 percent coil resistance)				
Mounting and termination	<ul style="list-style-type: none"> 1 PCB mounting; PCB terminals for coil and contacts (only available with enclosure code N, S or V) 2 PCB mounting; PCB term. for coil and contacts; 6.35mm (.250in) QC for contacts (only available with enclosure code N, S or V) 5 Flanged mounting; 4.75mm (.187) QC for coil; 6.35mm (.250in) QC for contacts (only available with enclosure code P) 						
Contact material	2 AgCdO	4 AgSnInO	7 AgCdO (Enhanced version)				
Coil voltage	Coil code: please refer to coil versions table						

¹⁾ "With knock off nib", a separate PN and description will be provided for code 1, please contact TE for details.

²⁾ "H" type coil is only available in mounting termination options 2 & 5.

T9A Series, DC Coil 30A PCB or Panel Mount Relay (Continued)

Product Code	Enclosure	Contacts	Coil	Mounting	Contact Material	Coil	Part Number				
T9AP1D52-12	Unsealed, plastic dust cover	1 form A, 1 NO	1W	Flanged mount, QC	AgCdO	12VDC	6-1419102-0				
T9AP1D52-24						24VDC	6-1419102-3				
T9AP1D52-48						48VDC	5-1419102-8				
T9AP1D54-24					AgSnOInO	24VDC	7-1423091-3				
T9AP5D52-12		1 form C, 1 CO			AgCdO	12VDC	5-1419102-4				
T9AP5D52-24			24VDC	5-1419102-2							
T9AP5D52-48						48VDC	6-1419102-4				
T9AP5D54-12					AgSnOInO	12VDC	7-1423091-4				
T9AP5D54-24						24VDC	7-1423091-5				
T9AS1D12-5	Wash tight, knock off nib	1 form A, 1 NO		pcb terminals	AgCdO	5VDC	2-1393210-0				
T9AS1D12-9			9VDC			2-1393210-2					
T9AS1D12-12			12VDC			1-1393210-3					
T9AS1D12-15			15VDC			1-1393210-4					
T9AS1D12-18			18VDC			1-1393210-5					
T9AS1D12-24			24VDC			1-1393210-8					
T9AS1D12-48			48VDC			1-1393210-9					
T9AS1D12-110			110VDC			1-1393210-2					
T9AS1D14-9								AgSnOInO	9VDC	2-2071229-5	
T9AS1D14-12									12VDC	5-1423091-7	
T9AS1D14-24									24VDC	6-1423091-3	
T9AS1D22-5								pcb + QC	AgCdO	5VDC	2-1419104-3
T9AS1D22-12							12VDC			1-1419104-7	
T9AS1D22-24							24VDC			2-1419104-1	
T9AS1D22-48			48VDC	2-1419104-2							
T9AS1D22-110					110VDC	1-1419104-6					
T9AS1L12-12			900mW	pcb terminals		12VDC	2-1393210-4				
T9AS1L12-24						24VDC	2-1393210-5				
T9AS1L14-24					AgSnOInO	24VDC	2-2071229-7				
T9AS1L22-18				pcb + QC	AgCdO	18VDC	2-1419104-6				
T9AS2L22-24		1 form B, 1 NC				24VDC	1423794-1				
T9AS5D12-5		1 form C, 1 CO	1W	pcb terminals		5VDC	3-1393210-9				
T9AS5D12-12						12VDC	3-1393210-3				
T9AS5D12-18						18VDC	3-1393210-4				
T9AS5D12-24						24VDC	3-1393210-7				
T9AS5D12-48						48VDC	3-1393210-8				
T9AS5D14-48					AgSnOInO		8-2071229-9				
T9AS5D12-110					AgCdO	110VDC	3-1393210-2				
T9AS5D22-5				pcb + QC			3-1419104-9				
T9AS5D22-12						12VDC	3-1419104-3				
T9AS5D22-24						24VDC	3-1419104-6				
T9AS5D22-110						110VDC	3-1419104-2				
T9AS5L12-12			900mW	pcb terminals		12VDC	4-1393210-1				
T9AS5L22-18				pcb + QC		18VDC	4-1419104-0				
T9AS5L22-24						24VDC	4-1419104-1				
T9AS5L22-48						48VDC	9-1419136-6				
T9AV1D12-12	Vented, flux tight	1 form A, 1 NO	1W	pcb terminals		12VDC	4-1393210-3				
T9AV1D12-18						18VDC	5-1393210-2				
T9AV1D22-18							pcb + QC		4-1419148-8		
T9AV1D22-24								24VDC	5-1419148-0		
T9AV1D22-48								48VDC	2-1423091-3		
T9AV1L12-12							900mW	pcb terminals		12VDC	1-1423091-8
T9AV1L22-24								pcb + QC		24VDC	4-1419104-2
T9AV2D22-24						1 form B, 1NC	1W				1419137-1
T9AV5D12-24						1 form C, 1CO		pcb terminals			4-1393210-8
T9AV5D22-18								pcb + QC		18VDC	5-1419148-2
T9AV5D22-24										24VDC	1419137-2

Note. This list represents the most common types and does not show all variants covered by this datasheet. Other types on request.