

ACPL-8x7

Multi-Channel Full-Pitch Phototransistor Optocoupler

Description

The ACPL-827 is a DC-input dual-channel, full-pitch phototransistor optocoupler that contains two light-emitting diodes optically coupled to two separate transistors. It is packaged in an 8-pin DIP package.

The ACPL-847 is a DC-input quad-channel, full-pitch phototransistor optocoupler that contains four light-emitting diodes optically coupled to four separate transistors. It is packaged in a 16-pin DIP package.

Both optocouplers are available in a wide-lead spacing option and a lead-bend SMD option with an input-output isolation voltage of 5000 V_{rms}. Response time, t_r, is typically 4 μs, and minimum CTR is 50% at an input current of 5 mA.

Features

- Current transfer ratio:
CTR: min. 50% at I_F = 5 mA, V_{CE} = 5V
- High input-output isolation voltage:
V_{ISO} = 5000 V_{rms}
- Response time:
t_r: typ. 4 μs at V_{CE} = 2V, I_C = 2 mA, R_L = 100Ω
- Compact dual inline package
- Safety and regulatory approvals:
 - CSA
 - UL 1577
 - IEC/EN/DIN EN 60747-5-5
- Options available:
 - Leads with 0.4-in. (10.16-mm) spacing (W00)
 - Lead bend for surface mounting (300)
 - Tape and reel for SMD (500) available only for the ACPL-827
 - IEC/EN/DIN EN 60747-5-5 approved (060)
 - Lead free (000E)

Applications

- I/O interface for programmable controllers, computers
- Sequence controllers
- System appliances, measuring instruments
- Signal transmission between circuits of different potentials and impedances

CAUTION! Take normal static precautions in handling and assembling this component to prevent damage and/or degradation that might be induced by electrostatic discharge (ESD). The components featured in this data sheet are not to be used in military or aerospace applications or environments. The components are not AEC-Q100 qualified and are not recommended for automotive applications.

ACPL-827 Pin Layout

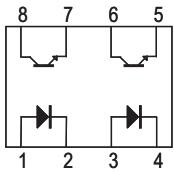

Pin 1, 3	Anode
Pin 2, 4	Cathode
Pin 5, 7	Emitter
Pin 6, 8	Collector

ACPL-847 Pin Layout

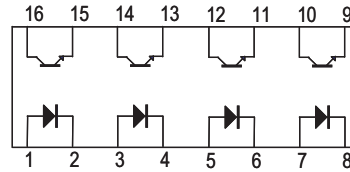

Pin 1, 3, 5, 7	Anode
Pin 2, 4, 6, 8	Cathode
Pin 9, 11, 13, 15	Emitter
Pin 10, 12, 14, 16	Collector

Ordering Information

ACPL-8x7 is UL Recognized with 5000 V_{rms} for 1 minute per UL1577 and is approved under CSA Component Acceptance Notice #5, File CA 88324.

Part Number	RoHS Compliant Option				Package	No. of Channels	Surface Mount	Gull Wing	Tape & Reel	IEC/EN/DIN EN 60747-5-5	Quantity
	Rank 0 50% <CTR> 600%	Rank B 130% <CTR> 260%	Rank C 200% <CTR> 400%	Rank G 130% <CTR> 400%							
ACPL-827	-000E	-00BE	-00CE		300-mil DIP-8	Dual					50 pcs per tube
	-300E	-30BE	-30CE		300-mil DIP-8		X	X			50 pcs per tube
	-500E	-50BE	-50CE		300-mil DIP-8		X	X	X		1000 pcs per reel
	-060E	-06BE	-06CE		300-mil DIP-8					X	50 pcs per tube
	-360E	-36BE	-36CE		300-mil DIP-8		X	X		X	50 pcs per tube
	-560E	-56BE	-56CE		300-mil DIP-8		X	X	X	X	1000 pcs per reel
	-W00E	-W0BE	-W0CE		400-mil DIP-8						50 pcs per tube
	-W60E	-W6BE	-W6CE		400-mil DIP-8					X	50 pcs per tube
ACPL-847	-000E			-00GE	300-mil DIP-16	Quad					25 pcs per tube
	-300E			-30GE	300-mil DIP-16		X	X			25 pcs per tube
	-060E			-06GE	300-mil DIP-16					X	25 pcs per tube
	-360E			-36GE	300-mil DIP-16		X	X		X	25 pcs per tube
	-W00E			-W0GE	400-mil DIP-16						25 pcs per tube
	-W60E			-W6GE	400-mil DIP-16					X	25 pcs per tube

To form an order entry, choose a part number from the Part Number column and combine it with the desired option from the Option column.

Example 1:

Specify ACPL-847-36GE to order the product consisting of 300-mil DIP-16, Quad Channel DC Gull Wing Surface Mount package in Tube packaging with 130%<CTR>400%, IEC/EN/DIN EN 60747-5-5 Safety Approval that is RoHS compliant.

Example 2:

Specify ACPL-847-W00E to order the product consisting of 400-mil DIP-16, Quad Channel DC package in Tube packaging with 50%<CTR>600% that is RoHS compliant.

Option data sheets are available. Contact your Broadcom sales representative or authorized distributor for information.

Package Outline Drawings

ACPL-827 Package Outline

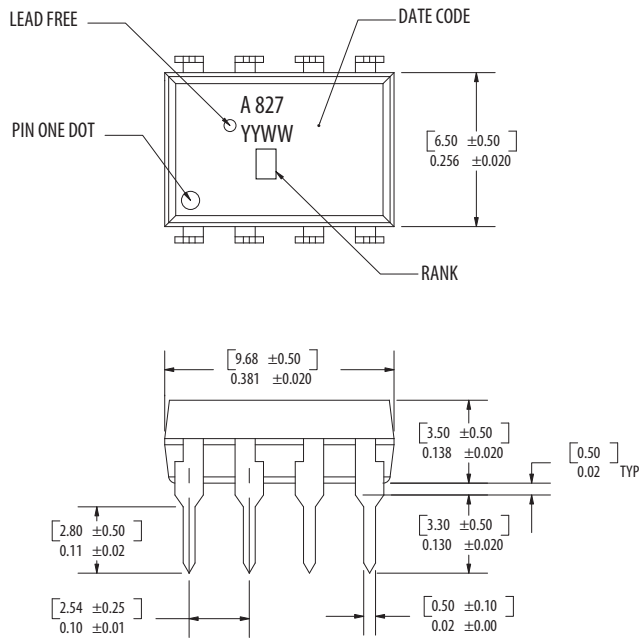

NOTE: Dimensions are in [millimeters] and inches.

ACPL-827 Package Outline – Option 060

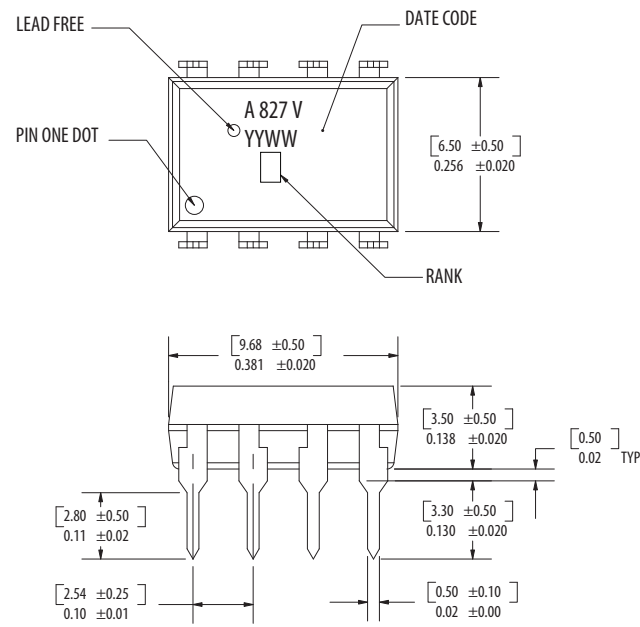

NOTE: Dimensions are in [millimeters] and inches.

ACPL-827 Package Outline – Option W00

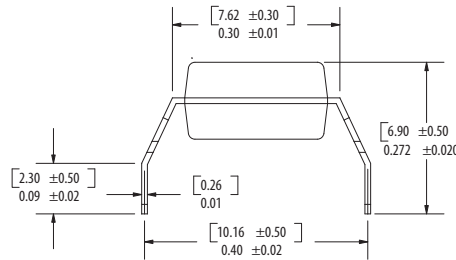
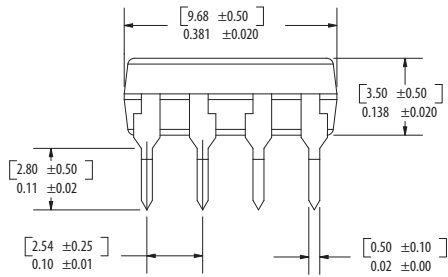
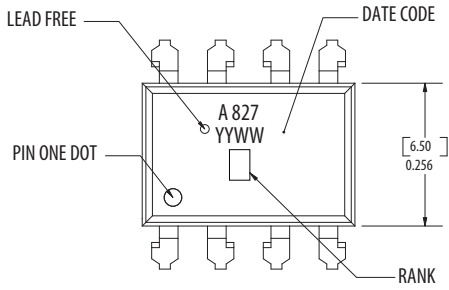

NOTE: Dimensions are in [millimeters] and inches.

ACPL-827 Package Outline – Option 300

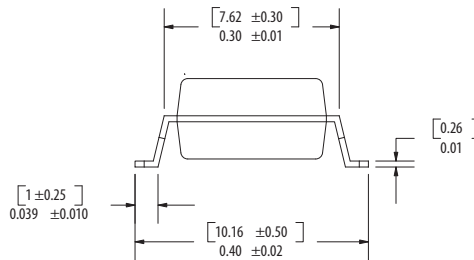
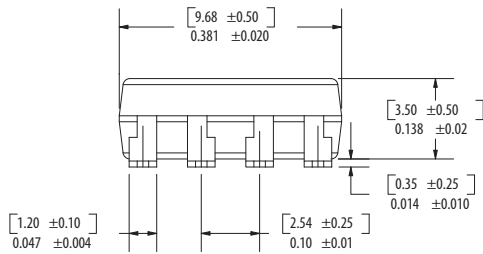
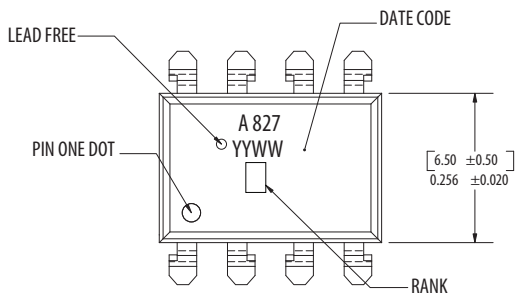

NOTE: Dimensions are in [millimeters] and inches.

ACPL-847 Package Outline

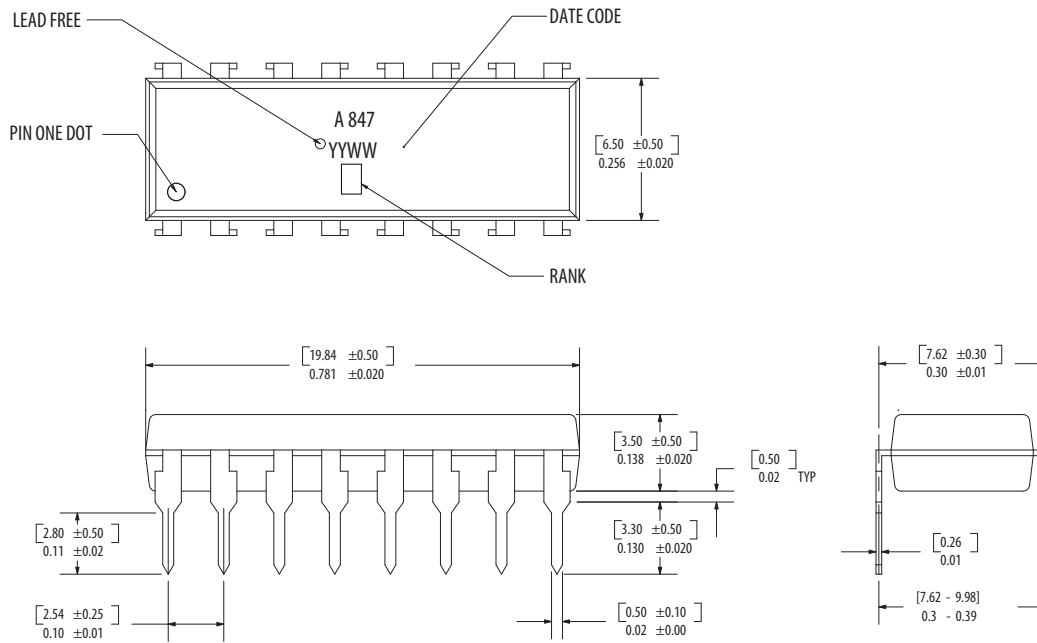

NOTE: Dimensions are in [millimeters] and inches.

ACPL-847 Package Outline – Option 060

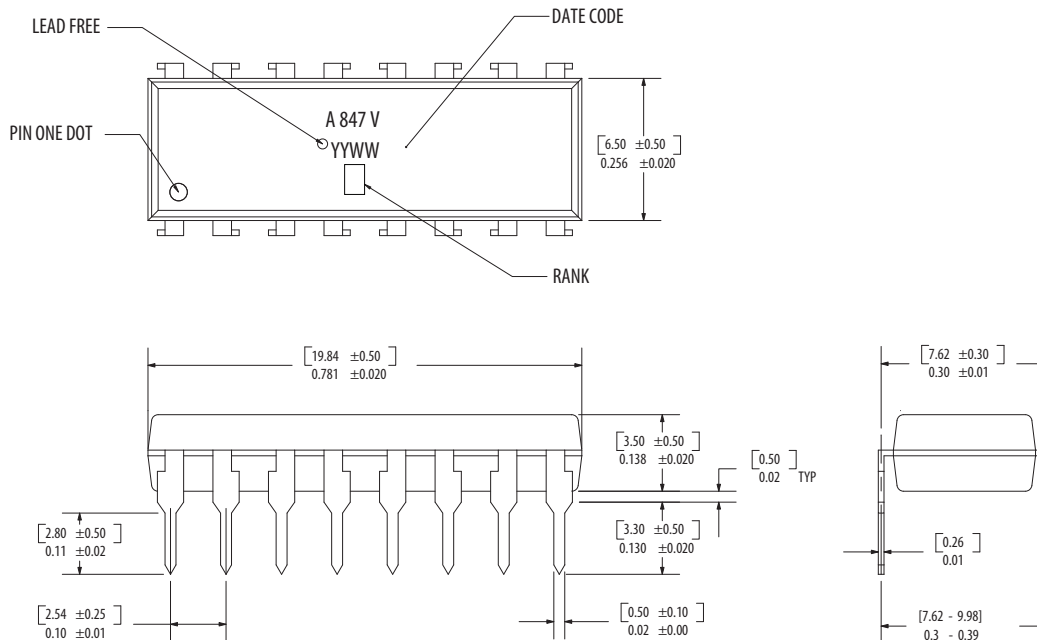

NOTE: Dimensions are in [millimeters] and inches.

ACPL-847 Package Outline – Option W00

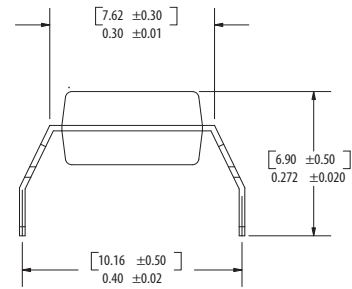
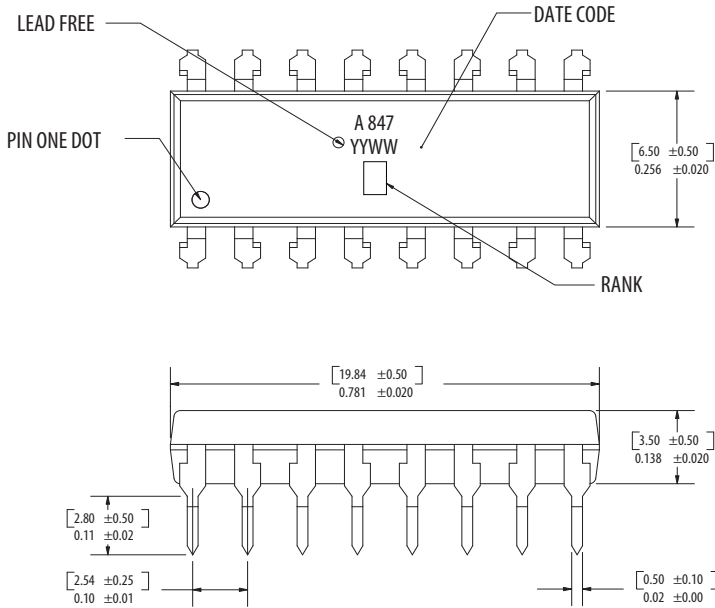

NOTE: Dimensions are in [millimeters] and inches.

ACPL-847 Package Outline – Option 300

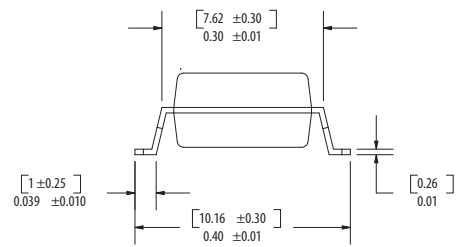
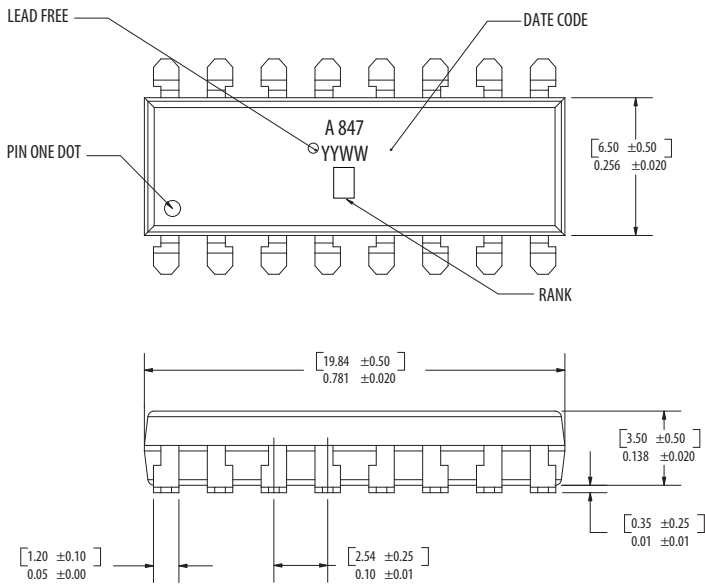

NOTE: Dimensions are in [millimeters] and inches.

Solder Reflow Temperature Profile

1. One-time soldering reflow is recommended within the condition of temperature and time profile shown to the right.
2. When using another soldering method such as infrared ray lamp, the temperature might rise partially in the mold of the device. Keep the temperature on the package of the device within the condition of (1) above.

NOTE: Use non-halide flux.

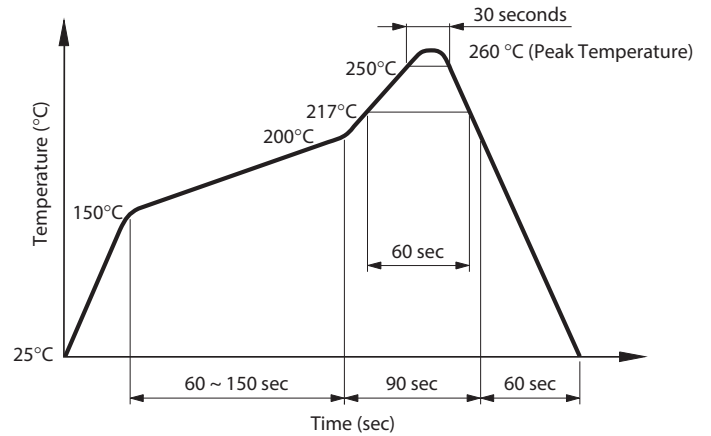

Absolute Maximum Ratings

Parameter	Symbol	Min.	Max.	Units
Storage Temperature	T_S	-55	125	°C
Operating Temperature	T_A	-30	100	°C
Junction Temperature	T_J	—	125	°C
Average Forward Current	$I_{F(AVG)}$	—	50	mA
Input Power Dissipation	P_I	—	70	mW
Input Reverse Voltage	V_R	—	6	V
Collector Current	I_C	—	50	mA
Collector-Emitter Voltage	V_{CEO}	—	70	V
Emitter-Collector Voltage	V_{ECO}	—	6	V
Isolation Voltage (AC for 1 minute, R.H. 40% ~ 60%)	V_{ISO}	—	5000	V_{rms}
Collector Power Dissipation	P_C	—	150	mW
Total Power Dissipation	P_{TOT}	—	200	mW
Lead Solder Temperature	260°C for 10 seconds, 1.6 mm below seating plane			

Electrical Specifications (DC)

Over recommended operating conditions unless otherwise specified.

Parameter	Symbol	Min.	Typ.	Max.	Units	Test Conditions	Note
Forward Voltage	V_F	—	1.2	1.4	V	$I_F = 20 \text{ mA}$	
Reverse Current	I_R	—	—	10	μA	$V_R = 4\text{V}$	
Terminal Capacitance	C_t	—	30	250	pF	$V = 0, f = 1 \text{ kHz}$	
Collector Dark Current	I_{CEO}	—	—	100	nA	$V_{CE} = 20\text{V}, I_F = 0 \text{ mA}$	
Collector-Emitter Breakdown Voltage	BV_{CEO}	70	—	—	V	$I_C = 0.1 \text{ mA}, I_F = 0 \text{ mA}$	
Emitter-Collector Breakdown Voltage	BV_{ECO}	6	—	—	V	$I_E = 10 \mu\text{A}, I_F = 0 \text{ mA}$	
Collector Current	I_C	2.5	—	30	mA	$I_F = 5 \text{ mA}, V_{CE} = 5\text{V}$	CTR = $(I_C/I_F) \times 100\%$
Current Transfer Ratio	CTR	50	—	600	%		
Collector-Emitter Saturation Voltage	$V_{CE(sat)}$	—	0.1	0.2	V	$I_F = 20 \text{ mA}, I_C = 1 \text{ mA}$	
Isolation Resistance	R_{ISO}	5×10^{10}	1×10^{11}	—	Ω	DC 500V, R.H. 40% ~ 60%	
Floating Capacitance	C_F	—	0.6	1	pF	$V = 0, f = 1 \text{ MHz}$	
Cut-off Frequency (–3 dB)	F_C	—	80	—	kHz	$V_{CE} = 5\text{V}, I_C = 2 \text{ mA},$ $R_L = 100\Omega$	See Figure 12 .
Response Time (Rise)	t_r	—	4	18	μs	$V_{CE} = 2\text{V}, I_C = 2 \text{ mA},$ $R_L = 100\Omega$	See Figure 12 .
Response Time (Fall)	t_f	—	3	18	μs		

Figure 1: Forward Current vs. Ambient Temperature

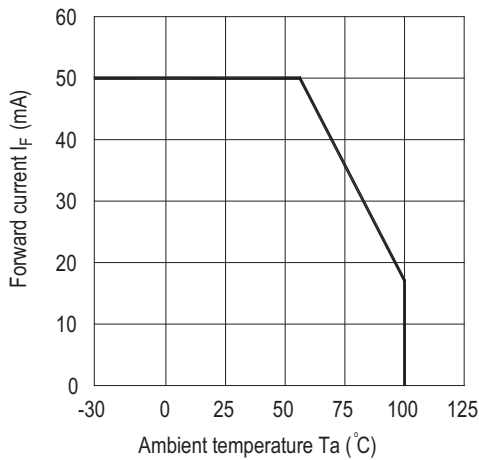

Figure 2: Collector Power Dissipation vs. Ambient Temperature

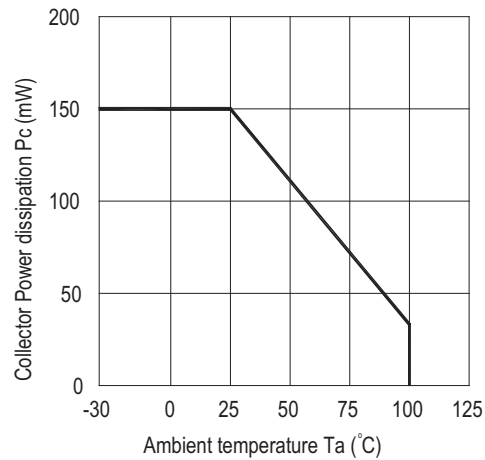

Figure 3: Collector-Emitter Saturation Voltage vs. Forward Current

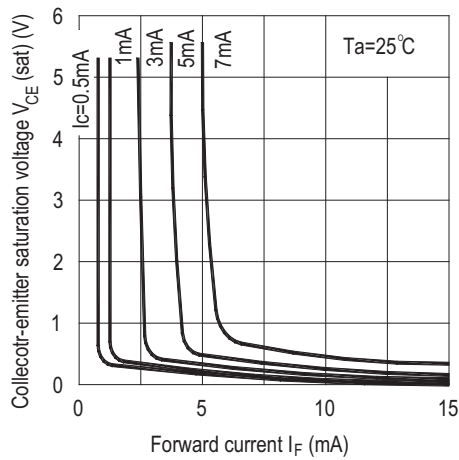

Figure 4: Forward Current vs. Forward Voltage

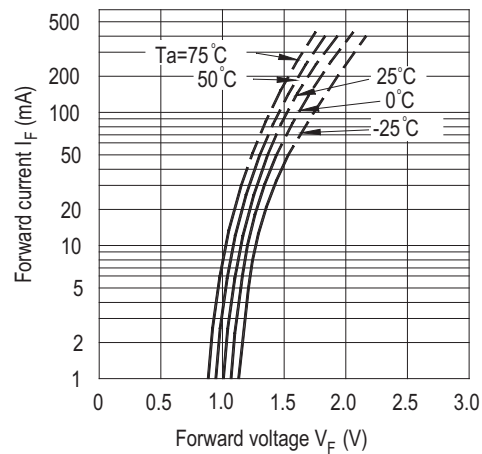

Figure 5: Current Transfer Ratio vs. Forward Current

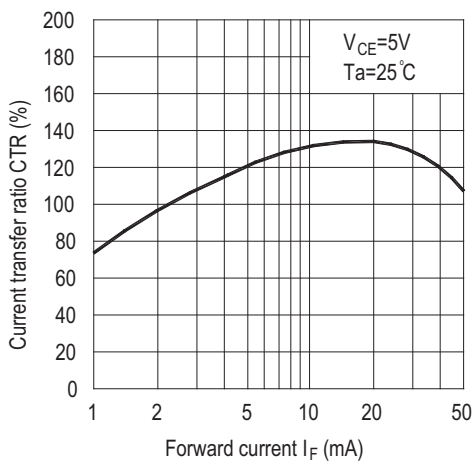

Figure 6: Collector Current vs. Collector-Emitter Voltage

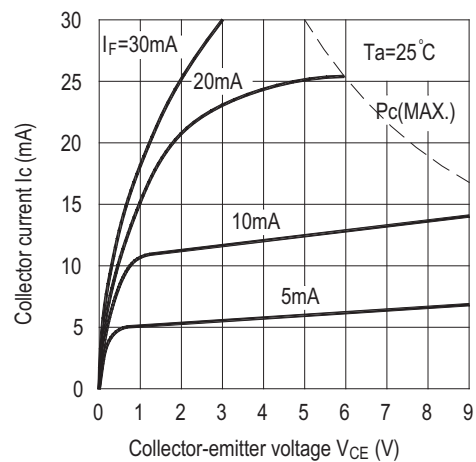

Figure 12: Test Circuit for Response Time

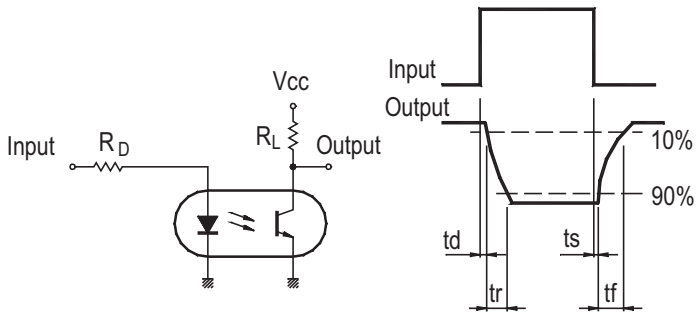
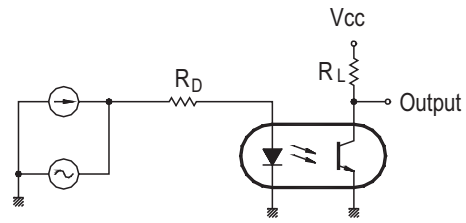

Figure 13: Test Circuit for Frequency Response



Copyright © 2008–2024 Broadcom. All Rights Reserved. The term “Broadcom” refers to Broadcom Inc. and/or its subsidiaries. For more information, go to www.broadcom.com. All trademarks, trade names, service marks, and logos referenced herein belong to their respective companies.

Broadcom reserves the right to make changes without further notice to any products or data herein to improve reliability, function, or design. Information furnished by Broadcom is believed to be accurate and reliable. However, Broadcom does not assume any liability arising out of the application or use of this information, nor the application or use of any product or circuit described herein, neither does it convey any license under its patent rights nor the rights of others.

