

Data Sheet | Item Number: 264-182

2-conductor terminal strip; without push-buttons; suitable for Ex e II applications; with snap-in mounting feet; 2-pole; for plate thickness 0.6 - 1.2 mm; Fixing hole 3.5 mm Ø; 2.5 mm²; CAGE CLAMP®; 2,50 mm²; light gray

<https://www.wago.com/264-182>



Color: ■ light gray

Similar to illustration

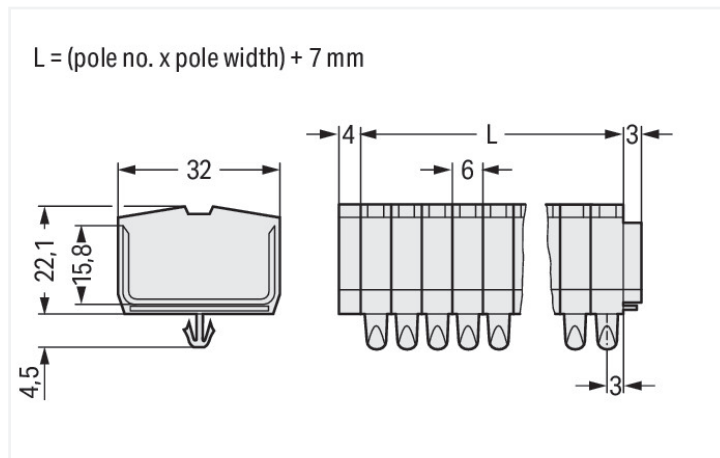

Dimensions in mm

Through terminal block, 264 Series, operating tool

Connecting conductors is quick and easy with this through terminal block (item number 264-182). Strip lengths must be between 8 and 9 mm when connecting conductors to this through terminal block. Our mini rail-mount terminal blocks are perfect for working in tight spaces thanks to their compact design. With various mounting and actuation options, they offer maximum flexibility. This product features conductor terminals and utilizes CAGE CLAMP®. Our CAGE CLAMP® connection offers a convenient and maintenance-free way to connect all types of conductors. You do not need to prepare the conductor in any way, such as crimping ferrules. The dimensions are (19 x 32 x 22.1) mm (width x height x depth). Depending on the type of conductor, this through terminal block is suitable for conductor cross sections ranging from 0.08 mm² to 2.5 mm².

This mini rail-mount terminal block is operated with an operating tool.

Electrical data

Ex information

Reference to hazardous areas	See "Downloads – Documentation – Additional Information: Technical Section; Technical Explanations"
Rated voltage EN (Ex e II)	690 V
Rated current (Ex e II)	23 A

General information

Wiring direction	Front-entry wiring
------------------	--------------------

Connection Data

Clamping units	4
Total number of potentials	2
Number of levels	1

Connection 1

Connection technology	CAGE CLAMP®
Actuation type	Operating tool
Connectable conductor materials	Copper
Solid conductor	0.08 ... 2.5 mm ² / 28 ... 12 AWG
Fine-stranded conductor	0.08 ... 2.5 mm ² / 28 ... 12 AWG
Note (conductor cross-section)	12 AWG: THHN, THWN
Strip length	8 ... 9 mm / 0.31 ... 0.35 inches

Connection 1

Pole number	2
Wiring direction	Front-entry wiring

Physical data

Width	19 mm / 0.748 inches
Height	32 mm / 1.26 inches
Height from the surface	22.1 mm / 0.87 inches
Depth	22.1 mm / 0.87 inches
Module width	6 mm / 0.236 inches

Mechanical data

Design	horizontal type
Mounting type	Snap-in foot
Marking level	Center marking

Material data

Note (material data)	Information on material specifications can be found here
Color	light gray
Material group	I
Insulation material (main housing)	Polyamide (PA66)
Flammability class per UL94	V0
Fire load	0.184 MJ
Halogen-free	Yes
Weight	9.5 g

Commercial data

Product Group	9 (Std Chassis Mt Blocks)
PU (SPU)	100 pcs
Packaging type	Box
Country of origin	DE
GTIN	4044918423250
Customs tariff number	85369010000

Product Classification

UNSPSC	39121410
eCl@ss 10.0	27-14-11-06
eCl@ss 9.0	27-14-11-06
ETIM 9.0	EC001284
ETIM 10.0	EC001284
ECCN	NO US CLASSIFICATION

Environmental Product Compliance

RoHS Compliance Status	Compliant, No Exemption
------------------------	-------------------------

Approvals / Certificates

General approvals **Declarations of conformity and manufacturer's declarations**



Approval	Standard	Certificate Name
CSA DEKRA Certification B.V.	C22.2	70010891
UR Underwriters Laboratories Inc.	UL 1059	E45172

Approval	Standard	Certificate Name
ATEX-Attestation of Conformity WAGO GmbH & Co. KG	-	-

Approvals for marine applications



Approval	Standard	Certificate Name
LR Lloyds Register	IEC 60998	LR22173030TA

Approvals for hazardous areas



Approval	Standard	Certificate Name
AEx UL International Germany GmbH c/o Physikalisch Technische Bundesanstalt	UL 60079	E185892 (AEx eb IIC resp. Ex eb IIC)
ATEX Physikalisch Technische Bundesanstalt (PTB)	EN 60079	PTB 98 ATEX 3129 U (II 2 G Ex eb IIC Gb bzw. I M 2 Ex eb I Mb)
CCC CQST/CNEx	GB/T 3836.3	2020312313000187 (Ex eb IIC Gb, Ex eb I Mb)
IECEX Physikalisch Technische Bundesanstalt (PTB)	IEC 60079	IECEX PTB 04.0003U (Ex e IIC Gb and Ex eb I Mb)
INMETRO TÜV Rheinland do Brasil Ltda.	IEC 60079	TÜV 12.1299 U

Downloads

Environmental Product Compliance

Compliance Search	
Environmental Product Compliance 264-182	↓

Documentation

Bid Text			
264-182	19.02.2019	xml 3.28 KB	
264-182	14.06.2017	doc 25.00 KB	

CAD/CAE-Data

CAD data	CAE data
2D/3D Models 264-182	EPLAN Data Portal 264-182
	WSCAD Universe 264-182
	ZUKEN Portal 264-182

1 Compatible Products

1.1 Optional Accessories

1.1.1 DIN-rail

1.1.1.1 Mounting accessories



Item No.: 210-154
Aluminum carrier rail; 1000 mm long; 18 mm wide; 7 mm high; silver-colored

1.1.2 Ferrule

1.1.2.1 Ferrule



Item No.: 216-131
Ferrule; Sleeve for 0.25 mm² / AWG 24; uninsulated; electro-tin plated; silver-colored



Item No.: 216-201
Ferrule; Sleeve for 0.5 mm² / 20 AWG; insulated; electro-tin plated; electrolytic copper; acc. to DIN 46228, Part 4/09.90; white



Item No.: 216-101
Ferrule; Sleeve for 0.5 mm² / AWG 22; uninsulated; electro-tin plated; silver-colored



Item No.: 216-202
Ferrule; Sleeve for 0.75 mm² / 18 AWG; insulated; electro-tin plated; gray



Item No.: 216-102
Ferrule; Sleeve for 0.75 mm² / AWG 20; uninsulated; electro-tin plated; silver-colored



Item No.: 216-203
Ferrule; Sleeve for 1 mm² / AWG 18; insulated; electro-tin plated; red



Item No.: 216-103
Ferrule; Sleeve for 1 mm² / AWG 18; uninsulated; electro-tin plated



Item No.: 216-204
Ferrule; Sleeve for 1.5 mm² / AWG 16; insulated; electro-tin plated; black



Item No.: 216-104
Ferrule; Sleeve for 1.5 mm² / AWG 16; uninsulated; electro-tin plated; silver-colored



Item No.: 216-205
Ferrule; Sleeve for 2.08 mm² / AWG 14; insulated; electro-tin plated; yellow



Item No.: 216-206
Ferrule; Sleeve for 2.5 mm² / AWG 14; insulated; electro-tin plated; blue

1.1.3 Installation

1.1.3.1 Cover



Item No.: 709-153

Cover; Type 1; suitable for cover carrier, type 1; 1 m long; transparent

1.1.3.2 Cover carrier



Item No.: 709-167

Cover carrier; Type 1; incl. fixing/retaining screws and knurled nut; suitable for 279 to 282 and 880 Series rail-mounted terminal blocks; suitable for 264 Series miniature rail-mounted terminal blocks; suitable for 270 Series sensor and actuator terminal blocks; gray

1.1.4 Jumper

1.1.4.1 Jumper



Item No.: 281-492

Jumper; 2-way; insulated; gray



Item No.: 264-402

Jumper; for conductor entry; 2-way; insulated; gray

1.1.5 Marking

1.1.5.1 Marker

Item No.: 2009-145/000-006

Mini-WSB Inline; for Smart Printer; 1700 pieces on roll; stretchable 5 - 5.2 mm; plain; snap-on type; blue

Item No.: 2009-145/000-007

Mini-WSB Inline; for Smart Printer; 1700 pieces on roll; stretchable 5 - 5.2 mm; plain; snap-on type; gray

Item No.: 2009-145/000-023

Mini-WSB Inline; for Smart Printer; 1700 pieces on roll; stretchable 5 - 5.2 mm; plain; snap-on type; green

Item No.: 2009-145/000-012

Mini-WSB Inline; for Smart Printer; 1700 pieces on roll; stretchable 5 - 5.2 mm; plain; snap-on type; orange

Item No.: 2009-145/000-005

Mini-WSB Inline; for Smart Printer; 1700 pieces on roll; stretchable 5 - 5.2 mm; plain; snap-on type; red

Item No.: 2009-145/000-024

Mini-WSB Inline; for Smart Printer; 1700 pieces on roll; stretchable 5 - 5.2 mm; plain; snap-on type; violet

Item No.: 2009-145

Mini-WSB Inline; for Smart Printer; 1700 pieces on roll; stretchable 5 - 5.2 mm; plain; snap-on type; white

Item No.: 2009-145/000-002

Mini-WSB Inline; for Smart Printer; 1700 pieces on roll; stretchable 5 - 5.2 mm; plain; snap-on type; yellow



Item No.: 248-501/000-006

Mini-WSB marking card; as card; not stretchable; plain; snap-on type; blue

Item No.: 248-501/000-007

Mini-WSB marking card; as card; not stretchable; plain; snap-on type; gray

Item No.: 248-501/000-023

Mini-WSB marking card; as card; not stretchable; plain; snap-on type; green

Item No.: 248-501/000-017

Mini-WSB marking card; as card; not stretchable; plain; snap-on type; light green



Item No.: 248-501/000-012

Mini-WSB marking card; as card; not stretchable; plain; snap-on type; orange

Item No.: 248-501/000-005

Mini-WSB marking card; as card; not stretchable; plain; snap-on type; red

Item No.: 248-501/000-024

Mini-WSB marking card; as card; not stretchable; plain; snap-on type; violet

Item No.: 248-501

Mini-WSB marking card; as card; not stretchable; plain; snap-on type; white



Item No.: 248-501/000-002

Mini-WSB marking card; as card; not stretchable; plain; snap-on type; yellow

1.1.6 Tool

1.1.6.1 Operating tool



Item No.: 210-658

Operating tool; Blade: 3.5 x 0.5 mm; with a partially insulated shaft; angled; short; multicoloured



Item No.: 210-720

Operating tool; Blade: 3.5 x 0.5 mm; with a partially insulated shaft; multicoloured



Item No.: 210-657

Operating tool; Blade: 3.5 x 0.5 mm; with a partially insulated shaft; short; multicoloured



Item No.: 209-130

Operating tool; made of insulating material; 1-way; for 264 Series (1-/2-way), 280, 281 Series (up to 3-way); natural

Installation Notes

Installation

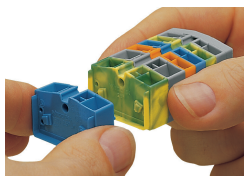

Assembling modular terminal blocks into terminal strips.

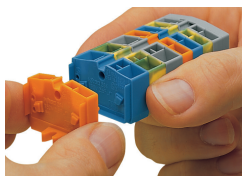

Mounting an "end terminal block" with mounting flange.

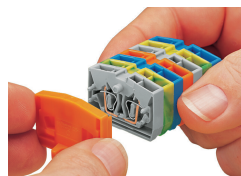

Mounting an end plate.

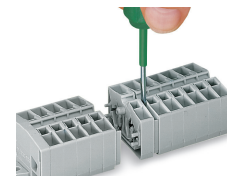

Removing a terminal block.

Conductor termination

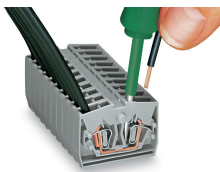

CAGE CLAMP® connection

Inserting a conductor.
With ferruled conductors, it is necessary to use a terminal block one size smaller than the conductor's nominal cross-section.

Commoning

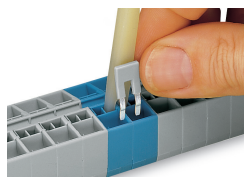

Commoning with comb-style jumper bar.

Testing

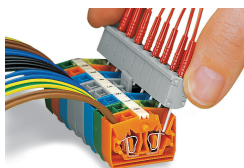

Testing by touch contact to the CAGE CLAMP® spring (limited to 0.5 A and 48 V test voltage) – test pins are not protected against accidental contact.

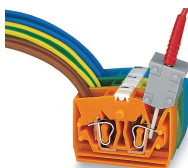

Testing via CAGE CLAMP® on the current bar (max. nominal current: 6 A). CAGE CLAMP® clamps individual test contacts. The maximum test voltage is 400 V.

Marking



Marking via Mini-WSB Quick Marking System.