

Data Sheet | Item Number: 745-3254

PCB terminal block; 4 mm²; Pin spacing 12.5 mm; 4-pole; CAGE CLAMP®; gray

<https://www.wago.com/745-3254>

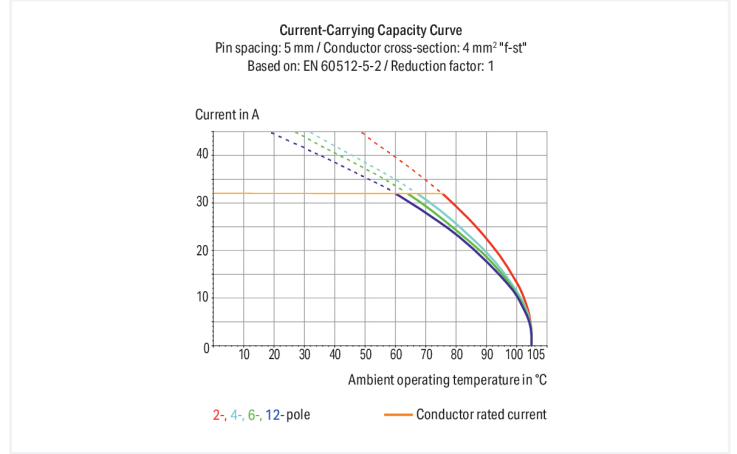

Color: ■ gray

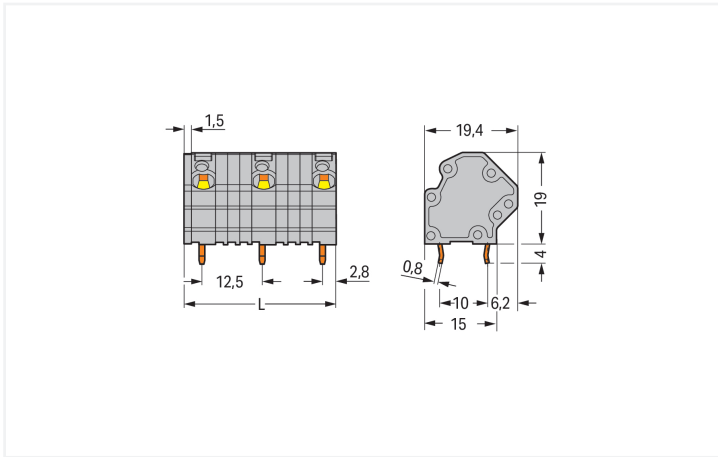

Dimensions in mm

L = (pole no. - 1) x pin spacing + 5 mm + 1.5 mm

PCB terminal block, 745 Series, with 12.5 mm pin spacing

Quick and easy connections are guaranteed with this PCB terminal block (item number 745-3254). It offers the flexibility needed for different mounting types. Strip lengths must be between 8 and 9 mm when connecting conductors to this PCB terminal block. Featuring one conductor terminal along with CAGE CLAMP®, this connector outperforms the competition. Our highly-rated and maintenance-free CAGE CLAMP® connection makes it easy to connect all types of conductors without having to prepare the conductor. For example, you don't need to crimp ferrules. The dimensions are (44 x 23 x 19.4) mm (width x height x depth). Depending on the conductor type, this PCB terminal block is ideal for conductor cross sections ranging from 0.08 mm² to 4 mm².

Tin is used for coating the contact surfaces. This PCB terminal block is operated with an operating tool. THT is used to assemble the PCB terminal block. The conductor is designed to be inserted at an angle of 45°.

Notes

Variants:	Other pole numbers Versions for Ex e II and Ex i Versions for Ex i Other colors Mixed-color PCB connector strips Direct marking Other versions (or variants) can be requested from WAGO Sales or configured at https://configurator.wago.com/ .
-----------	--

Electrical data

Ratings per	IEC/EN 60664-1			Approvals per	UL 1059		
Overvoltage category	III	III	II	Use group	B	C	D
Pollution degree	3	2	2	Rated voltage	600 V	600 V	-
Nominal voltage	1000 V	1000 V	1000 V	Rated current	20 A	20 A	-
Rated impulse withstand voltage	8 kV	8 kV	8 kV				
Rated current	32 A	32 A	32 A				

Approvals per	CSA		
Use group	B	C	D
Rated voltage	600 V	600 V	-
Rated current	20 A	20 A	-

Connection Data

Clamping units	4	Connection 1	
Total number of potentials	4	Connection technology	CAGE CLAMP®
Number of connection types	1	Actuation type	Operating tool
Number of levels	1	Solid conductor	0.08 ... 4 mm ² / 28 ... 12 AWG
		Fine-stranded conductor	0.08 ... 4 mm ² / 28 ... 12 AWG
		Fine-stranded conductor; with insulated ferrule	0.25 ... 2.5 mm ²
		Fine-stranded conductor; with uninsulated ferrule	0.25 ... 2.5 mm ²
		Strip length	8 ... 9 mm / 0.31 ... 0.35 inches
		Conductor connection direction to PCB	45 °
		Pole number	4

Physical data

Pin spacing	12.5 mm / 0.492 inches
Width	44 mm / 1.732 inches
Height	23 mm / 0.906 inches
Height from the surface	19 mm / 0.748 inches
Depth	19.4 mm / 0.764 inches
Solder pin length	4 mm
Solder pin dimensions	0.8 x 1.2 mm
Drilled hole diameter	1.5 ^(+0.1) mm

PCB contact

PCB contact	THT
Solder pin arrangement	over the entire terminal strip (in-line)
Number of solder pins per potential	2

Material data

Note (material data)	Information on material specifications can be found here
Color	gray
Material group	I
Insulation material (main housing)	Polyamide (PA66)
Flammability class per UL94	V0
Clamping spring material	Chrome-nickel spring steel (CrNi)
Contact material	Electrolytic copper (E _{cu})
Contact Plating	Tin
Fire load	0.218 MJ
Weight	11.7 g

Environmental requirements

Limit temperature range	-60 ... +105 °C
-------------------------	-----------------

Commercial data

Product Group	4 (Printed Circuit Connectors)
PU (SPU)	72 pcs
Packaging type	Box
Country of origin	PL
GTIN	4045454001094
Customs tariff number	85369010000

Product Classification

UNSPSC	39121409
eCl@ss 10.0	27-44-04-01
eCl@ss 9.0	27-44-04-01
ETIM 9.0	EC002643
ETIM 10.0	EC002643
ECCN	NO US CLASSIFICATION

Environmental Product Compliance

RoHS Compliance Status	Compliant, No Exemption
------------------------	-------------------------

Approvals / Certificates

General approvals



General approvals

cURus Underwriters Laboratories Inc.	UL 1059	E45172
--	---------	--------

Approval	Standard	Certificate Name
CCA DEKRA Certification B.V.	EN 60947	NTR NL-7095
CCA DEKRA Certification B.V.	EN 60947	71-112275
CSA DEKRA Certification B.V.	C22.2 No. 158	1604421

Declarations of conformity and manufacturer's declarations

Approval	Standard	Certificate Name
EU-Declaration of Confor- mity WAGO GmbH & Co. KG	-	-
UK-Declaration of Confor- mity WAGO GmbH & Co. KG	-	-

Downloads

Environmental Product Compliance

Compliance Search
Environmental Product Compliance 745-3254 

Documentation

Additional Information
Technical Section 03.04.2019 pdf 2027.26 KB 

CAD/CAE-Data

CAD data
2D/3D Models 745-3254 

CAE data
EPLAN Data Portal 745-3254 

ZUKEN Portal 745-3254 
--

PCB Design

Symbol and Footprint via SamacSys 745-3254 
--

Symbol and Footprint via Ultra Librarian 745-3254 

1 Compatible Products

1.1 Optional Accessories

1.1.1 Test and measurement

1.1.1.1 Testing accessories



Item No.: 210-136

Test plug; 2 mm Ø; with 500 mm cable; red

1.1.2 Tool

1.1.2.1 Operating tool



Item No.: 210-658

Operating tool; Blade: 3.5 x 0.5 mm; with a partially insulated shaft; angled; short; multicoloured



Item No.: 210-720

Operating tool; Blade: 3.5 x 0.5 mm; with a partially insulated shaft; multicoloured



Item No.: 210-657

Operating tool; Blade: 3.5 x 0.5 mm; with a partially insulated shaft; short; multicoloured

Installation Notes

Conductor termination

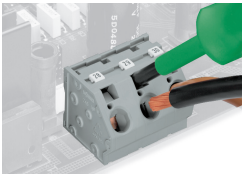

Inserting/removing a conductor via 5.5 mm screwdriver – 745 Series, 16 mm².

Marking

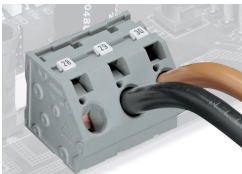

Marking via Mini-WSB and WMB markers or factory direct marking – 745 Series.

Testing

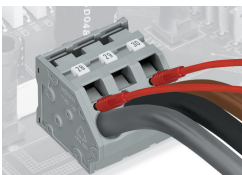

Testing with test plug – 745 Series.

Subject to changes. Please also observe the further product documentation!

Current addresses can be found at: www.wago.com