

Data Sheet | Item Number: 253-107

2-conductor PCB terminal block; 1.5 mm²; Pin spacing 5 mm; 7-pole; PUSH WIRE®; gray

<https://www.wago.com/253-107>

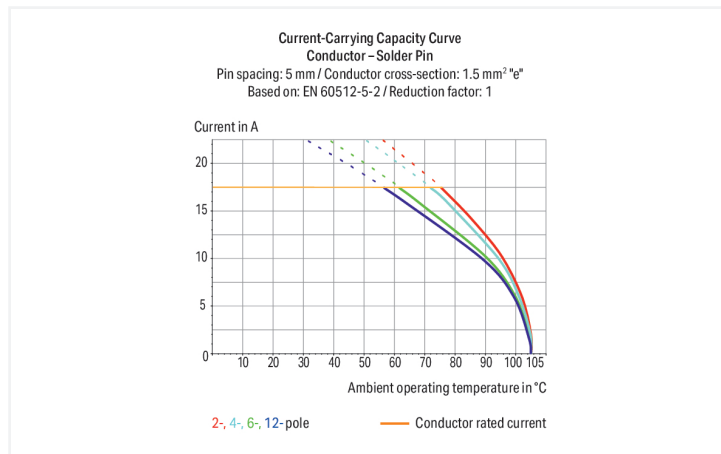
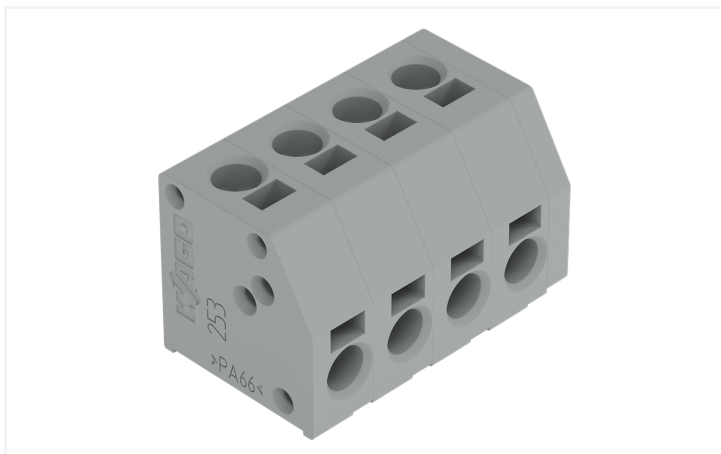

Color: ■ gray

Similar to illustration

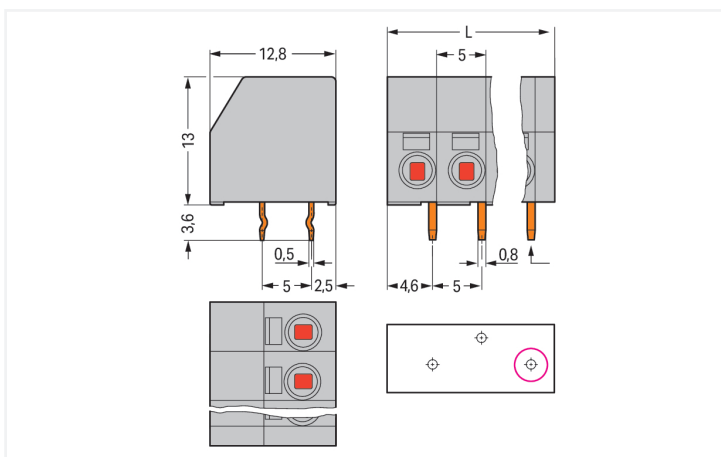

Dimensions in mm

L = (pole no. x pin spacing) + 2 mm First solder pin, front right (red circle)

PCB terminal block, 253 Series, PUSH WIRE®

Easily, quickly and safely connect conductors with this PCB terminal block (item number 253-107). It offers the flexibility needed for different mounting types. Ensure that the strip lengths are between 8.5 and 9.5 mm when connecting conductors to this PCB terminal block. Featuring two conductor terminals along with PUSH WIRE® as well as PUSH WIRE®, this product outperforms the competition. Our PUSH WIRE® connection is the quick and easy method for connecting solid conductors. The item's dimensions are (37 x 16.6 x 12.8) mm (width x height x depth). This PCB terminal block is suitable for conductor cross sections ranging from 0.5 mm² to 1.5 mm² on one side and for conductor cross sections ranging from 0.5 mm² to 1.5 mm² on the other side.

The contact surface is coated with tin. This PCB terminal block is operated with an operating tool. THT is used to assemble the PCB terminal block. Insert the conductor into the board at a 0° angle..

Notes

Variants: 	Other pole numbers Other colors Mixed-color PCB connector strips Direct marking Other versions (or variants) can be requested from WAGO Sales or configured at https://configurator.wago.com/ .
-------------------	--

Electrical data

Ratings per	IEC/EN 60664-1		
Overvoltage category	III	III	II
Pollution degree	3	2	2
Nominal voltage	320 V	320 V	630 V
Rated impulse withstand voltage	4 kV	4 kV	4 kV
Rated current	17.5 A	17.5 A	17.5 A

Approvals per	UL 1059		
Use group	B	C	D
Rated voltage	300 V	-	300 V
Rated current	8 A	-	5 A

Approvals per	CSA		
Use group	B	C	D
Rated voltage	300 V	-	300 V
Rated current	8 A	-	5 A

Connection Data

Clamping units	14
Total number of potentials	7
Number of connection types	2
Number of levels	1

Connection 1

Connection type	PUSH WIRE® connection
Connection technology	PUSH WIRE®
Number of connection points	1
Actuation type	Operating tool
Solid conductor	0.5 ... 1.5 mm ² / 20 ... 16 AWG
Strip length	8.5 ... 9.5 mm / 0.33 ... 0.37 inches
Note (strip length)	7 ... 8 mm / 0.28 ... 0.31 inch (for wiring on both sides)
Conductor connection direction to PCB	0°
Pole number	7

Connection 2

Connection type	PUSH WIRE® connection
Connection technology	PUSH WIRE®
Number of connection points	1
Solid conductor	0.5 ... 1.5 mm ² / 20 ... 16 AWG
Strip length	8.5 ... 9.5 mm / 0.33 ... 0.37 inches
Note (strip length)	7 ... 8 mm / 0.28 ... 0.31 inch (for wiring on both sides)
Conductor connection direction to PCB	90°

Physical data

Pin spacing	5 mm / 0.197 inches
Width	37 mm / 1.457 inches
Height	16.6 mm / 0.654 inches
Height from the surface	13 mm / 0.512 inches
Depth	12.8 mm / 0.504 inches
Solder pin length	3.6 mm
Solder pin dimensions	0.5 x 0.8 mm
Drilled hole diameter with tolerance	1.1 ^(+0.1) mm

PCB contact

PCB contact	THT
Solder pin arrangement	over the entire terminal strip (staggered)
Number of solder pins per potential	1

Material data

Note (material data)	Information on material specifications can be found here
Color	gray
Material group	I
Insulation material (main housing)	Polyamide (PA66)
Flammability class per UL94	V0
Clamping spring material	Chrome-nickel spring steel (CrNi)
Contact material	Electrolytic copper (E _{Cu})
Contact Plating	Tin
Fire load	0.114 MJ
Weight	6.2 g

Environmental requirements

Limit temperature range	-60 ... +105 °C
-------------------------	-----------------

Commercial data

Product Group	4 (Printed Circuit Connectors)
PU (SPU)	120 (30) pcs
Packaging type	Box
Country of origin	CN
GTIN	4044918689403
Customs tariff number	85369010000

Product Classification

UNSPSC	39121409
eCl@ss 10.0	27-44-04-01
eCl@ss 9.0	27-44-04-01
ETIM 9.0	EC002643
ETIM 10.0	EC002643
ECCN	NO US CLASSIFICATION

Environmental Product Compliance	
RoHS Compliance Status	Compliant, No Exemption

Approvals / Certificates

General approvals			Declarations of conformity and manufacturer's declarations		
Approval	Standard	Certificate Name	Approval	Standard	Certificate Name
CCA DEKRA Certification B.V.	EN 60947	NTR NL-7649	EU-Declaration of Confor- mity WAGO GmbH & Co. KG	-	-
CCA DEKRA Certification B.V.	EN 60998	NTR NL 6580	UK-Declaration of Confor- mity WAGO GmbH & Co. KG	-	-
CCA DEKRA Certification B.V.	EN 60998	2126302.02			
cURus Underwriters Laboratories Inc.	UL 1059	E45172			
ENEC DEKRA Certification B.V.	EN 60947	71-101931			
UL UL International Germany GmbH	UL 1977	E45171			

Downloads

Environmental Product Compliance	
Compliance Search	
Environmental Product Compliance 253-107	↓

Documentation

Additional Information			
Technical Section	03.04.2019	pdf 2027.26 KB	↓

CAD/CAE-Data

CAD data		CAE data	
2D/3D Models 253-107	↓	EPLAN Data Portal 253-107	↓
		ZUKEN Portal 253-107	↓

PCB Design	
Symbol and Footprint via SamacSys 253-107	
Symbol and Footprint via Ultra Librarian 253-107	

1 Compatible Products

1.1 Optional Accessories

1.1.1 Marking

1.1.1.1 Marking strip



Item No.: 210-833
 Marking strips; 25 m on roll; 6 mm wide; plain; Self-adhesive; white



Item No.: 210-332/500-202
 Marking strips; as a DIN A4 sheet; MARKED; 1-16 (160x); Height of marker strip: 3 mm; Strip length 182 mm; Horizontal marking; Self-adhesive; white



Item No.: 210-332/500-205
 Marking strips; as a DIN A4 sheet; MARKED; 1-32 (80x); Height of marker strip: 3 mm; Strip length 182 mm; Horizontal marking; Self-adhesive; white



Item No.: 210-332/500-204
 Marking strips; as a DIN A4 sheet; MARKED; 17-32 (160x); Height of marker strip: 3 mm; Strip length 182 mm; Horizontal marking; Self-adhesive; white



Item No.: 210-332/500-206
 Marking strips; as a DIN A4 sheet; MARKED; 33-48 (160x); Height of marker strip: 3 mm; Strip length 182 mm; Horizontal marking; Self-adhesive; white

1.1.2 Tool

1.1.2.1 Operating tool



Item No.: 210-719
 Operating tool; Blade: 2.5 x 0.4 mm; with a partially insulated shaft



Item No.: 210-648
 Operating tool; Blade: 2.5 x 0.4 mm; with a partially insulated shaft; angled; short



Item No.: 210-647
 Operating tool; Blade: 2.5 x 0.4 mm; with a partially insulated shaft; multicoloured

Installation Notes

Conductor termination

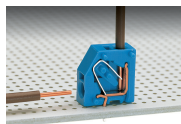

Inserting a conductor via push-in termination.

Conductor removal

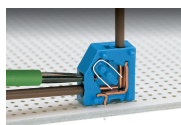

Removing a conductor via 2.5 mm screwdriver.

Installation

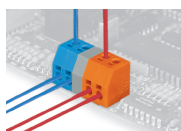

Mixed-color terminal strips (with or without spacer) are available upon request.