

Data Sheet | Item Number: 750-461
 2-channel analog input; For Pt100/RTD resistance sensors

<https://www.wago.com/750-461>

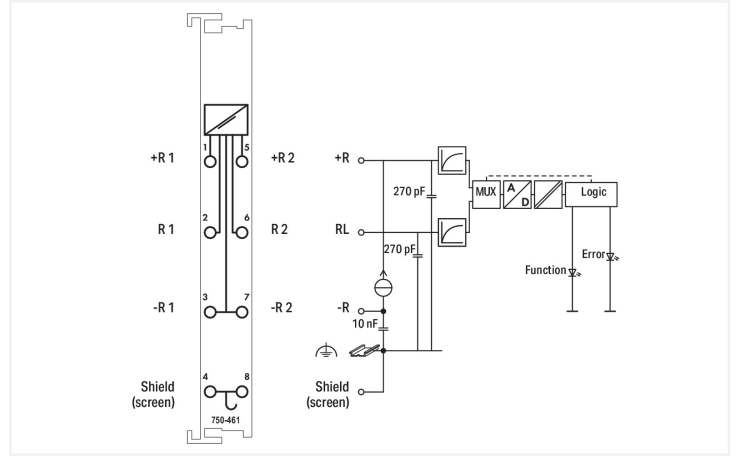

Color: ■ light gray

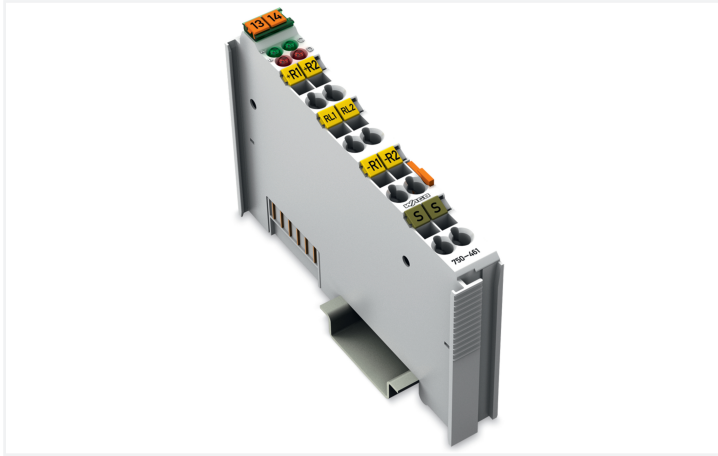
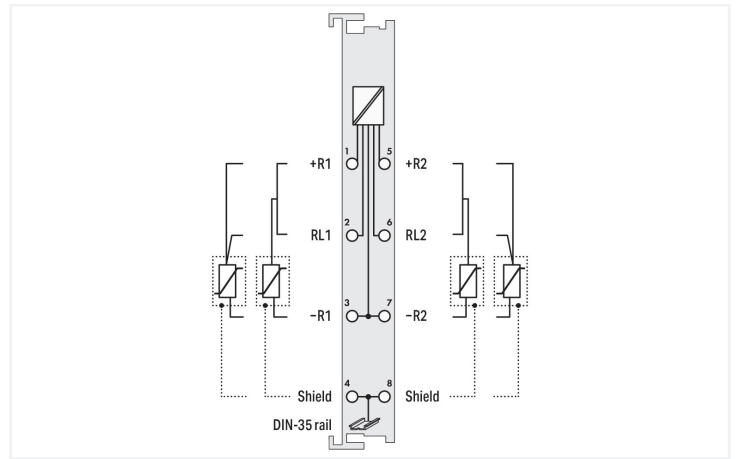
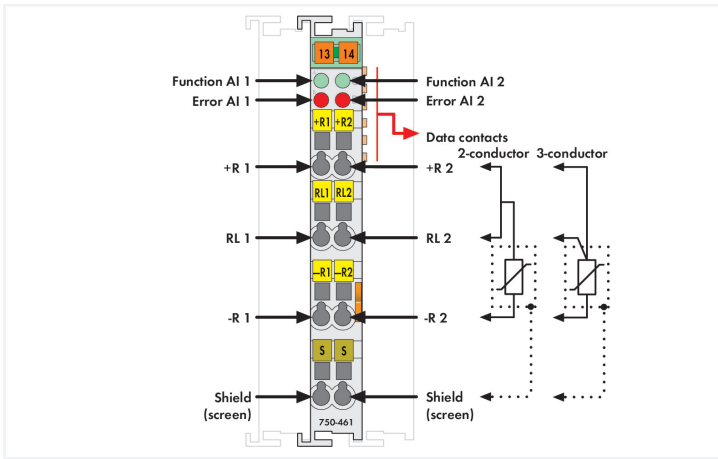

This analog input module directly connects to Pt resistance sensors.

Two- or three-wire sensors can be connected.

The module automatically linearizes the entire temperature range. A sensor error (short circuit, line break or measurement range overflow) is indicated by a red LED.

A green LED indicates readiness for operation and error-free communication with the coupler.

The shield directly connects to the DIN-rail.

Technical data

Number of analog inputs	2
Total number of channels (module)	2
Signal type	Resistance measurement
Sensor connection	2 x (2-wire, 3-wire)
Data width	2 x 16-bit data; 2 x 8-bit control/status (optional)
Resolution (over entire range)	0.1 °C
Conversion time (typ.)	320 ms
Measurement error (reference temperature)	25 °C
Measurement error, deviation (max.) from the upper-range value	0.2 %
Temperature error (max.) of the upper-range value	0.01 %/K
Measuring current (typ.)	0.5 mA
Response time (max.)	4 s

Technical data

Sensor types	Pt100
Temperature range	-200 ... +850 °C
Supply voltage (system)	5 VDC; via data contacts
Current consumption (system supply)	80 mA
Isolation	500 V system/field
Indicators	LED (A, C) green: Function AI 1, AI 2; LED (B, D) red: Error AI 1, AI 2

Connection Data

Connection technology: I/O	8 x CAGE CLAMP®
Connectable conductor materials	Copper
Connection type	Inputs/outputs
Solid conductor	0.08 ... 2.5 mm ² / 28 ... 14 AWG
Fine-stranded conductor	0.08 ... 2.5 mm ² / 28 ... 14 AWG
Strip length	8 ... 9 mm / 0.31 ... 0.35 inches

Physical data

Width	12 mm / 0.472 inches
Height	100 mm / 3.937 inches
Depth	69.8 mm / 2.748 inches
Depth from upper-edge of DIN-rail	62.6 mm / 2.465 inches

Mechanical data

Mounting type	DIN-35 rail
Pluggable connector	fixed

Material data

Color	light gray
Housing material	Polycarbonate; polyamide 6.6
Fire load	0.932 MJ
Weight	50.7 g
Conformity marking	CE

Environmental requirements

Ambient temperature (operation)	0 ... +55 °C
Ambient temperature (storage)	-40 ... +85 °C
Protection type	IP20
Pollution degree	2 per IEC 61131-2
Operating altitude	0 ... 2000 m / 0 ... 6562 ft
Mounting position	Horizontal left, horizontal right, horizontal top, horizontal bottom, vertical top and vertical bottom
Relative humidity (without condensation)	95 %
Vibration resistance	4g per IEC 60068-2-6
Shock resistance	15g per IEC 60068-2-27
EMC immunity to interference	per EN 61000-6-2, marine applications
EMC emission of interference	per EN 61000-6-4, marine applications
Exposure to pollutants	per IEC 60068-2-42 and IEC 60068-2-43
Permissible H ₂ S contaminant concentration at a relative humidity 75 %	10 ppm
Permissible SO ₂ contaminant concentration at a relative humidity 75 %	25 ppm

Commercial data

Product Group	15 (I/O System)
PU (SPU)	1 pcs
Packaging type	Box
Country of origin	DE
GTIN	4045454486679
Customs tariff number	85437090990

Product Classification

UNSPSC	32101506
eCl@ss 10.0	27-24-26-01
eCl@ss 9.0	27-24-26-01
ETIM 9.0	EC001596
ETIM 10.0	EC001596
ECCN	NO US CLASSIFICATION

Environmental Product Compliance

CAS-No.	1303-86-2 1317-36-8 7439-92-1
REACH Candidate List Substance	Diboron trioxide Lead Lead monoxide
RoHS Compliance Status	Compliant,With Exemption
RoHS Exemption	7(c)-I
SCIP notification number (Austria)	75429670-35e3-4569-a32e-8e020348f292
SCIP notification number (Belgium)	bc0715bd-bcab-4da3-92dc-0865a4afe4d8
SCIP notification number (Bulgaria)	e74b48b1-9cb8-41f2-8ffb-42980ae09654
SCIP notification number (Czech Republic)	606ce528-9956-410f-8b46-09b4bb84b033
SCIP notification number (Denmark)	0b1c8695-17df-469a-8d76-27e5dfedd880
SCIP notification number (Finland)	e9157e84-07c5-404f-be1e-fee97dad9dd1
SCIP notification number (France)	e1650623-f1de-4481-9923-0b1cfed3eda0
SCIP notification number (Germany)	3e718a18-6d86-4b76-970f-a5da6282c797
SCIP notification number (Hungary)	5f27b834-6bd0-46cf-bd12-62d975caf481
SCIP notification number (Italy)	1fca87de-4bb2-4af1-8393-eac58bcfa30e
SCIP notification number (Netherlands)	62be64b0-d628-49d4-bc55-65fcd4e4702f
SCIP notification number (Poland)	3ba89961-35de-4aa7-b416-65eebc778cf1
SCIP notification number (Romania)	e5a6ca0d-b02c-40a5-9ac0-ce77d43350d5
SCIP notification number (Sweden)	79fbe2b1-5c4e-4fe3-9706-7fdd31324fb0

Approvals / Certificates

General approvals



Approval	Standard	Certificate Name
EAC GZO Almaty Standart	TP TC 020/2011	EAC CoC 03083
KC National Radio Research Agency	Article 58-2, Clause 3	MSIP-REM-W43-AIM750
UL Underwriters Laboratories Inc. (ORDINARY LOCATIONS)	UL 508	E175199

Declarations of conformity and manufacturer's declarations

Approval	Standard	Certificate Name
EU-Declaration of Conformity WAGO GmbH & Co. KG	-	-
UK-Declaration of Conformity WAGO GmbH & Co. KG	-	-

Approvals for marine applications



Approval	Standard	Certificate Name
ABS American Bureau of Shipping	-	25-0415412
BSH Bundesamt fuer Seeschiff-fahrt und Hydrographie	-	1104
BV Bureau Veritas S.A.	-	13453/E0 BV
DNV DNV GL SE	DNV-CG-0339,Aug.2021	TAA0000194
KR Korean Register of Shipping	-	KR HMB05880-AC001
LR Lloyds Register EMEA	-	LR22180952TA
NK Nippon Kaiji Kyokai	Guidel. Perform. Type Ap-provals	TA25276M
PRS Polski Rejestr Statków	-	TE/1101/880590/23
RINA RINA Germany GmbH	-	ELE343521XG001

Approvals for hazardous areas



Approval	Standard	Certificate Name
ATEX TUEV Nord Cert GmbH	EN 60079-0	TUEV14ATEX148929X (II 3 G Ex ec IIC T4 Gc)
CCCEX CQST/CNEx	CNCA-C23-01	2020312310000213 (Ex ec IIC T4 Gc)
IECEX TUEV Nord Cert GmbH	IEC 60079-0	IECEX TUN 14.0035 X (Ex ec IIC T4 Gc)
INMETRO TÜV Rheinland do Brasil Lt-da.	IEC 60079-0	TÜV 12.1297 X
UKEx WAGO GmbH & Co. KG	EN 60079-0	UKCA_WA GO22UKEX003X_ec
UL Underwriters Laboratories Inc. (HAZARDOUS LOCA-TIONS)	UL 121201	E198726

Downloads

Environmental Product Compliance

Compliance Search

Environmental Product Compliance 750-461	↓
--	-------------------

Documentation

Manual			
Product Manual 2-channel Analog Input for Resistance Sensors	V 1.4.1	pdf 2916.84 KB	↓
System Manual Series 750/753			↓

System Description			
750/753 Series I/O-System – General Product Information		pdf 953.35 KB	↓
Overview on WAGO-I/O-SYSTEM 750 approvals		pdf 770.48 KB	↓

Bid Text			
750-461	19.02.2019	xml 4.58 KB	↓
750-461	20.10.2017	doc 28.00 KB	↓
ausschreiben.de 750-461			↓

Instruction Leaflet			
CCC Ex (Additional information)	26.04.2023	pdf 159.76 KB	↓

CAD/CAE-Data

CAD data
2D/3D Models 750-461

CAE data

EPLAN Data Portal 750-461

WSCAD Universe 750-461

ZUKEN Portal 750-461

Device Files

Device Driver

WAGO USB Service Kabel Treiber / Serie 750 und 857	6.5.3.0 10.09.2014	zip 4721.96 KB	
--	-----------------------	-------------------	--

1 Compatible Products

1.1 Optional Accessories

1.1.1 DIN-rail

1.1.1.1 Mounting accessories



Item No.: 210-196
Aluminum carrier rail; 35 x 8.2 mm; 1.6 mm thick; 2 m long; unslotted; similar to EN 60715; silver-colored



Item No.: 210-198
Copper carrier rail; 35 x 15 mm; 2.3 mm thick; 2 m long; unslotted; according to EN 60715; copper-colored



Item No.: 210-197
Steel carrier rail; 35 x 15 mm; 1.5 mm thick; 2 m long; slotted; similar to EN 60715; silver-colored



Item No.: 210-114
Steel carrier rail; 35 x 15 mm; 1.5 mm thick; 2 m long; unslotted; similar to EN 60715; silver-colored



Item No.: 210-118
Steel carrier rail; 35 x 15 mm; 2.3 mm thick; 2 m long; unslotted; according to EN 60715; silver-colored



Item No.: 210-112
Steel carrier rail; 35 x 7.5 mm; 1 mm thick; 2 m long; slotted; according to EN 60715; "Hole width 25 mm; silver-colored



Item No.: 210-113
Steel carrier rail; 35 x 7.5 mm; 1 mm thick; 2 m long; unslotted; according to EN 60715; silver-colored

1.1.2 Marking

1.1.2.1 Group marker carrier



Item No.: 750-106
Group marker carrier

1.1.2.2 Marker



Item No.: 750-100
Marker card; as a DIN A4 sheet; plain



Item No.: 2009-145/000-006
Mini-WSB Inline; for Smart Printer; 1700 pieces on roll; stretchable 5 - 5.2 mm; plain; snap-on type; blue



Item No.: 2009-145/000-007
Mini-WSB Inline; for Smart Printer; 1700 pieces on roll; stretchable 5 - 5.2 mm; plain; snap-on type; gray



Item No.: 2009-145/000-023
Mini-WSB Inline; for Smart Printer; 1700 pieces on roll; stretchable 5 - 5.2 mm; plain; snap-on type; green



Item No.: 2009-145/000-012
Mini-WSB Inline; for Smart Printer; 1700 pieces on roll; stretchable 5 - 5.2 mm; plain; snap-on type; orange



Item No.: 2009-145/000-005
Mini-WSB Inline; for Smart Printer; 1700 pieces on roll; stretchable 5 - 5.2 mm; plain; snap-on type; red













Item No.: 2009-145/000-024
Mini-WSB Inline; for Smart Printer; 1700 pieces on roll; stretchable 5 - 5.2 mm; plain; snap-on type; violet



Item No.: 2009-145
Mini-WSB Inline; for Smart Printer; 1700 pieces on roll; stretchable 5 - 5.2 mm; plain; snap-on type; white

1.1.2.2 Marker



 <p>Item No.: 2009-145/000-002 Mini-WSB Inline; for Smart Printer; 1700 pieces on roll; stretchable 5 - 5.2 mm; plain; snap-on type; yellow</p>	 <p>Item No.: 248-501/000-006 Mini-WSB marking card; as card; not stretchable; plain; snap-on type; blue</p>	 <p>Item No.: 248-501/000-007 Mini-WSB marking card; as card; not stretchable; plain; snap-on type; gray</p>	 <p>Item No.: 248-501/000-023 Mini-WSB marking card; as card; not stretchable; plain; snap-on type; green</p>
 <p>Item No.: 248-501/000-017 Mini-WSB marking card; as card; not stretchable; plain; snap-on type; light green</p>	 <p>Item No.: 248-501/000-012 Mini-WSB marking card; as card; not stretchable; plain; snap-on type; orange</p>	 <p>Item No.: 248-501/000-005 Mini-WSB marking card; as card; not stretchable; plain; snap-on type; red</p>	 <p>Item No.: 248-501/000-024 Mini-WSB marking card; as card; not stretchable; plain; snap-on type; violet</p>
 <p>Item No.: 248-501 Mini-WSB marking card; as card; not stretchable; plain; snap-on type; white</p>	 <p>Item No.: 248-501/000-002 Mini-WSB marking card; as card; not stretchable; plain; snap-on type; yellow</p>		

1.1.2.3 Marker carrier

 <p>Item No.: 750-103 Group marker carrier</p>
--

1.1.3 Shield termination

1.1.3.1 Shield clamping saddles

 <p>Item No.: 790-108 Shield clamping saddle; 11 mm wide; diameter of compatible conductor; 3 ... 8 mm</p>	 <p>Item No.: 790-208 Shield clamping saddle; 12.4 mm wide; 3 ... 8 mm</p>	 <p>Item No.: 790-116 Shield clamping saddle; 19 mm wide; diameter of compatible conductor; 7 ... 16 mm</p>	 <p>Item No.: 790-216 Shield clamping saddle; 21.8 mm wide; 6 ... 16 mm</p>
 <p>Item No.: 790-124 Shield clamping saddle; 27 mm wide; diameter of compatible conductor; 6 ... 24 mm</p>	 <p>Item No.: 790-220 Shield clamping saddle; 30 mm wide; 6 ... 20 mm</p>	 <p>Item No.: 790-140 Shield clamping saddle; diameter of compatible conductor</p>	

1.1.4 System enclosure

1.1.4.1 System enclosure

 <p>Item No.: 850-825 IP65 enclosure; Aluminium (RAL 7032); Wx-HxD (160x100x160 mm); 9 x M12, 4 x M20</p>	 <p>Item No.: 850-826 IP65 enclosure; Aluminium (RAL 7032); Wx-HxD (240x100x160 mm); 4 x M20, 4 x M16, 14 x M12 cable grip</p>	 <p>Item No.: 850-827 IP65 enclosure; Aluminium (RAL 7032); Wx-HxD (320x100x160 mm); 4 x M20, 8 x M16, 17 x M12 cable grip</p>	 <p>Item No.: 850-828 IP65 enclosure; Aluminium (RAL 7032); Wx-HxD (480x100x160 mm); 4 x M20, 10 x M16, 35 x M12 cable grip</p>
 <p>Item No.: 850-826/002-000 IP65 enclosure; Aluminium (RAL 7035); Wx-HxD (240x100x160 mm); 4 x M20, 4 x M16, 14 x M12 cable grip</p>	 <p>Item No.: 850-827/002-000 IP65 enclosure; Aluminium (RAL 7035); Wx-HxD (320x100x160 mm); 4 x M20, 8 x M16, 17 x M12 cable grip</p>	 <p>Item No.: 850-828/002-000 IP65 enclosure; Aluminium (RAL 7035); Wx-HxD (480x100x160 mm); 4 x M20, 10 x M16, 35 x M12 cable grip</p>	 <p>Item No.: 850-834 IP65 enclosure; Polyester (RAL 7032); Wx-HxD (164x100x164 mm); 9 x M12, 4 x M20</p>
 <p>Item No.: 850-835 IP65 enclosure; Polyester (RAL 7032); Wx-HxD (244x100x164 mm); 4 x M20, 4 x M16, 14 x M12 cable grip</p>	 <p>Item No.: 850-836 IP65 enclosure; Polyester (RAL 7032); Wx-HxD (324x100x164 mm); 4 x M20, 8 x M16, 17 x M12 cable grip</p>	 <p>Item No.: 850-814/002-000 IP65 enclosure; Sheet steel (RAL 7035); Wx-HxD (200x120x200 mm); without flange plate</p>	 <p>Item No.: 850-815/002-000 IP65 enclosure; Sheet steel (RAL 7035); Wx-HxD (300x120x200 mm); without flange plate</p>

1.1.4.1 System enclosure



Item No.: 850-816/002-000

IP65 enclosure; Sheet steel (RAL 7035); Wx-HxD (400x120x200 mm); without flange plate

Item No.: 850-817/002-000

IP65 enclosure; Sheet steel (RAL 7035); Wx-HxD (600x120x200 mm); without flange plate