

Data Sheet | Item Number: 788-312

Relay module; Nominal input voltage: 24 VDC; 2 changeover contacts; Limiting continuous current: 8 A; Red status indicator; Module width: 15 mm; 2,50 mm²; gray

<https://www.wago.com/788-312>

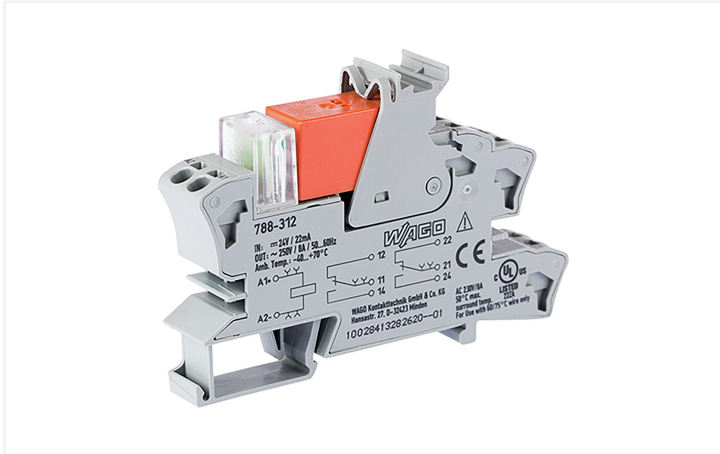

Color: ■ gray

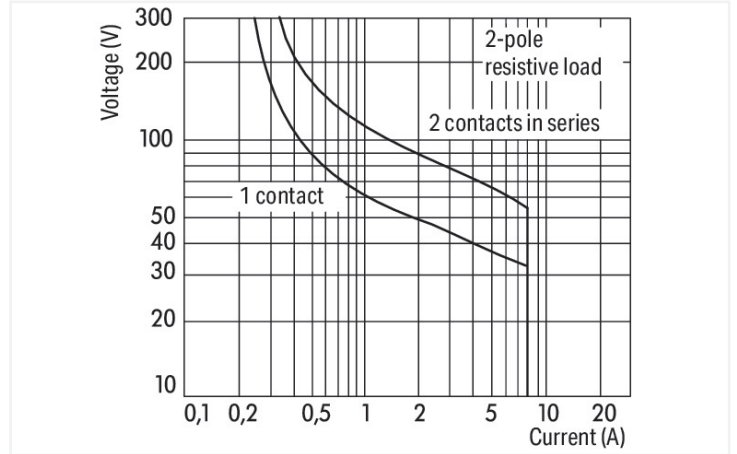

DC load limit curve

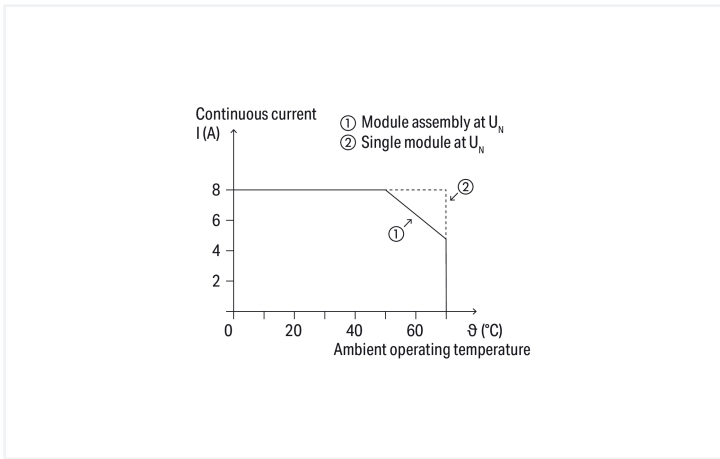

Current-carrying capacity curve

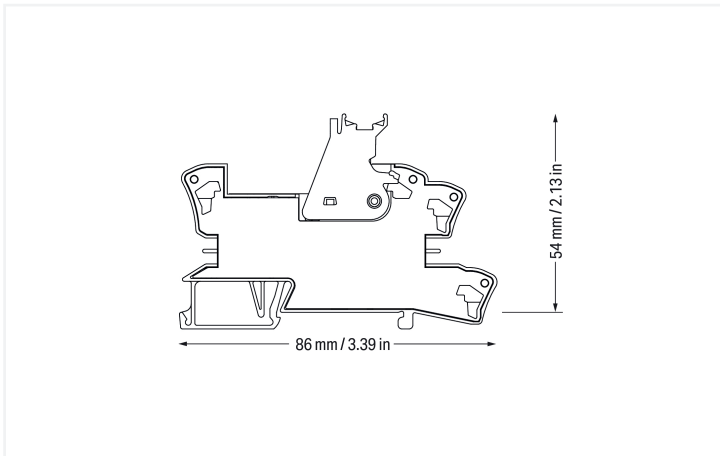
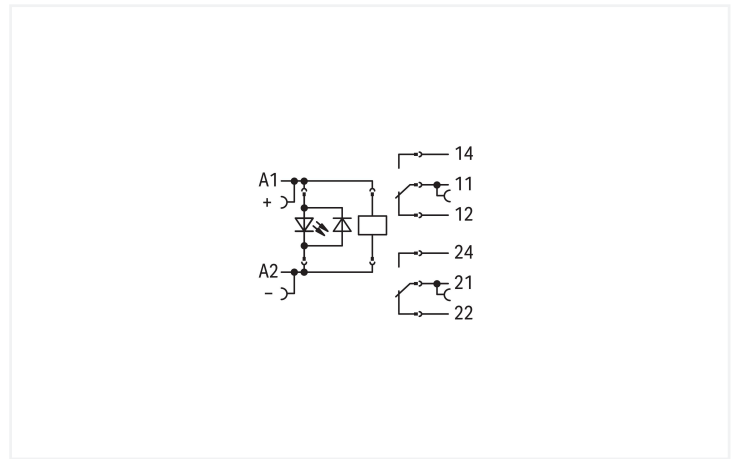

Notes

Safety Information	A separator plate (e.g., 209-191) must be used for voltages exceeding 250 V between adjacent relay modules and to comply with reinforced insulation requirements.
Note	Reinforced insulation between coil and contacts To protect the relay coils and contacts, inductive loads must be dampened with an effective protection circuit.

Technical data

Control circuit

Nominal input voltage U_N	24 VDC
Input voltage range	±10 %
Nominal input current at U_N	19 mA

Load circuit

Number of changeover/switchover contacts	2
Contact material (relay)	AgNi 90/10
Limiting continuous current	8 A
Inrush current (resistive) max.	(AC) 15 A / 4 s
Switching Voltage, Max.	250 VAC
Switching power (resistive) max.	AC 2000 VA; DC (see load limit curve)
Switching capacity	AC-15: 3 A / 250 VAC; DC-13: 2 A / 24 VDC
Recommended minimum load	12 V / 10 mA
Pull-in time (typ.)	8 ms
Drop-out time (typ.)	13 ms
Bounce time (typ.)	10 ms
Electrical life (NO; resistive load; 23 °C)	10 x 10 ³ switching operations
Mechanical life	30 x 10 ⁶ switching operations
Switching frequency with/without load (max.)	6 min ⁻¹ / 1200 min ⁻¹

Signaling

Status indicator	Red LED
------------------	---------

Safety and protection

Rated Voltage	250 V
Rated impulse withstand voltage	4 kV
Pollution degree	3
Dielectric strength (control/load circuit) (AC, 1 min)	5 kVrms
Dielectric strength (open contact) (AC, 1 min)	1 kVrms
Dielectric strength (load/load circuit) (AC, 1 min)	2.5 kVrms
Safety Information	A separator plate (e.g., 209-191) must be used for voltages exceeding 250 V between adjacent relay modules and to comply with reinforced insulation requirements.
Protection type	IP20

Connection Data

Connection technology	Push-in CAGE CLAMP®
Solid conductor	0.34 ... 2.5 mm ² / 22 ... 14 AWG
Fine-stranded conductor	0.34 ... 2.5 mm ² / 22 ... 14 AWG
Strip length	9 ... 10 mm / 0.35 ... 0.39 inches

Physical data

Width	15 mm / 0.591 inches
Height	86 mm / 3.386 inches
Depth from upper-edge of DIN-rail	54 mm / 2.126 inches

Mechanical data

Mounting type	DIN-35 rail
---------------	-------------

Material data

Note (material data)	Information on material specifications can be found here
Color	gray
Fire load	1.286 MJ
Weight	45.5 g

Environmental requirements

Ambient temperature (operation at U_N)	-40 ... +70 °C
Ambient temperature UL (operation at U_N)	-40 ... +50 °C
Ambient temperature (storage)	-40 ... +70 °C
Processing temperature	-25 ... +50 °C
Temperature range of connection cable	$\geq (T_{\text{ambient}} + 20 \text{ K})$

Standards and Specifications

Standards/specifications	EN 61010-2-201 EN 61810-1 EN 61373 UL 508
--------------------------	--

Basic relay

WAGO Basic Relay	788-156
------------------	---------

Commercial data

Product Group	6 (INTERFACE ELECTRONIC)
PU (SPU)	20 (1) pcs
Packaging type	Box
Country of origin	CN
GTIN	4055143184137
Customs tariff number	85364900990

Product Classification

UNSPSC	39122334
eCl@ss 10.0	27-37-16-01
eCl@ss 9.0	27-37-16-01
ETIM 9.0	EC001437
ETIM 10.0	EC001437
ECCN	NO US CLASSIFICATION

Environmental Product Compliance

CAS-No.	7439-92-1 7440-43-9
REACH Candidate List Substance	Cadmium Lead
RoHS Compliance Status	Compliant, No Exemption
SCIP notification number (Austria)	24d2c028-d78a-47d5-854b-7e27c80364cd
SCIP notification number (Belgium)	5ac37397-baae-4e58-a3d3-61435578db9f
SCIP notification number (Bulgaria)	de1cb4da-97c0-4008-9269-da951ab1ef16
SCIP notification number (Czech Republic)	c403f750-ef31-42a4-aad9-12e1c6f4fe05
SCIP notification number (Denmark)	08d49e8e-6e93-4346-8e74-784ca6f59bef
SCIP notification number (Finland)	d1c1e038-ca63-45b9-b8ad-df061b16ed25
SCIP notification number (France)	853c5f70-bd31-4f01-9c72-acb268d802cd
SCIP notification number (Germany)	29efa91e-de52-404a-a3b5-7a02ea50bb5
SCIP notification number (Hungary)	05ecf633-f69c-4fac-b89c-9c17adcb3af3
SCIP notification number (Italy)	d0c19709-ee3b-4706-ba8a-2fcb782cda1
SCIP notification number (Netherlands)	d263f759-daa0-4cac-a565-b787a6062566
SCIP notification number (Poland)	252526f9-7a88-4d6b-b7b5-7ba6d6981d94
SCIP notification number (Romania)	d9b9f293-6b25-417a-96e3-84fe7cee93b2
SCIP notification number (Sweden)	522525c4-ff5a-471a-bb93-f6be7d85275a

Approvals / Certificates

General approvals



Approval	Standard	Certificate Name
EAC GZO Almaty Standart	TP TC 004/2011	EAC CoC 03084
UL Underwriters Laboratories Inc. (ORDINARY LOCATIONS)	UL 508	E175199 Vol.1 Sec.6

Declarations of conformity and manufacturer's declarations

Approval	Standard	Certificate Name
EU-Declaration of Conformity WAGO GmbH & Co. KG	-	-
UK-Declaration of Conformity WAGO GmbH & Co. KG	-	-

Downloads

Environmental Product Compliance





Compliance Search
Environmental Product Compliance 788-312

Documentation

Bid Text			
788-312	25.01.2019	docx 16.40 KB	
788-312	19.02.2019	xml 4.60 KB	
ausschreiben.de 788-312			

Instruction Leaflet			
Sockets with Elementary Relay/ SSR	V 1.0.1 09.10.2020	pdf 2271.22 KB	

CAD/CAE-Data

CAD data	CAE data
2D/3D Models 788-312 	EPLAN Data Portal 788-312 
	WSCAD Universe 788-312 
	ZUKEN Portal 788-312 

1 Compatible Products

1.1 Optional Accessories

1.1.1 Basic relay

1.1.1.1 Basic relay



Item No.: 788-156

Basic relay; Nominal input voltage: 24 VDC; 2 changeover contacts; Limiting continuous current: 8 A; Module width: 13 mm; Module height: 15 mm

1.1.2 Ferrule

1.1.2.1 Ferrule



Item No.: 216-241

Ferrule; Sleeve for 0.5 mm² / 20 AWG; insulated; electro-tin plated; electrolytic copper; gastight crimped; acc. to DIN 46228, Part 4/09.90; white



Item No.: 216-242

Ferrule; Sleeve for 0.75 mm² / 18 AWG; insulated; electro-tin plated; electrolytic copper; gastight crimped; acc. to DIN 46228, Part 4/09.90; gray



Item No.: 216-243

Ferrule; Sleeve for 1 mm² / AWG 18; insulated; electro-tin plated; electrolytic copper; gastight crimped; acc. to DIN 46228, Part 4/09.90; red



Item No.: 216-244

Ferrule; Sleeve for 1.5 mm² / AWG 16; insulated; electro-tin plated; electrolytic copper; gastight crimped; acc. to DIN 46228, Part 4/09.90; black



Item No.: 216-542

Twin ferrule; Sleeve for 2 x 1 mm² / AWG 2 x 18; red, insulated; 12 mm long; red

1.1.3 Indicators

1.1.3.1 Status indication



Item No.: 788-120

Accessories for relay modules; Operation status indicator: red; Nominal operating voltage: 24 VDC

1.1.4 Jumper

1.1.4.1 Jumper



Item No.: 788-118

Jumper; for jumper slot; 2-way; from 1 to 3; insulated; light gray

Item No.: 788-113

Jumper; for jumper slot; 2-way; insulated; light gray

Item No.: 859-402

Jumper; for jumper slot; 2-way; insulated; light gray

Item No.: 788-114

Jumper; for jumper slot; 3-way; insulated; light gray



Item No.: 788-115

Jumper; for jumper slot; 4-way; insulated; light gray

Item No.: 788-116

Jumper; for jumper slot; 6-way; insulated; light gray

Item No.: 788-117

Jumper; for jumper slot; 8-way; insulated; light gray

1.1.5 Marking

1.1.5.1 Double marker carrier



Item No.: 209-128

Adaptor; gray

1.1.5.2 Group marker carrier



Item No.: 249-105

Group marker carrier; gray

Item No.: 209-145

Group marker carrier; white

1.1.5.3 Marker



Item No.: 209-183

Marker; white

Item No.: 793-502

WMB marking card; as card; MARKED; 1 ... 10 (10x); not stretchable; Horizontal marking; snap-on type; white

Item No.: 793-503

WMB marking card; as card; MARKED; 11 ... 20 (10x); not stretchable; Horizontal marking; snap-on type; white

Item No.: 793-504

WMB marking card; as card; MARKED; 21 ... 30 (10x); not stretchable; Horizontal marking; snap-on type; white



Item No.: 793-505

WMB marking card; as card; MARKED; 31 ... 40 (10x); not stretchable; Horizontal marking; snap-on type; white

Item No.: 793-501

WMB marking card; as card; not stretchable; plain; snap-on type; white

Item No.: 2009-115

WMB-Inline; for Smart Printer; 1500 pieces on roll; stretchable 5 - 5.2 mm; plain; snap-on type; white

1.1.5.4 Marking device



Item No.: 210-110

Fiber-tip pen

1.1.5.5 Marking strip



Item No.: 2009-110

Marking strips; for Smart Printer; on reel; not stretchable; plain; snap-on type; white

1.1.5.6 Protective marker cover



Item No.: 209-184

Protection cover; transparent

1.1.6 Tool

1.1.6.1 Operating tool



Item No.: 210-720

Operating tool; Blade: 3.5 x 0.5 mm; with a partially insulated shaft; multicoloured

Installation Notes

Conductor termination

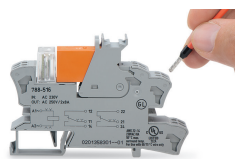

Conductor termination

Commoning



Easy commoning using adjacent jumpers

Marking



Marking using WMB Multi markers and group marker carriers.

Subject to changes. Please also observe the further product documentation!

Current addresses can be found at: www.wago.com