

THIS DRAWING IS UNPUBLISHED. RELEASED FOR PUBLICATION 20  
 © COPYRIGHT 20 BY - ALL RIGHTS RESERVED.

REVISIONS							
LOC	DIST	P	LTR	DESCRIPTION	DATE	DWN	APVD
-	-	A		FIRST RELEASED	03SEP2019	WH	DZ

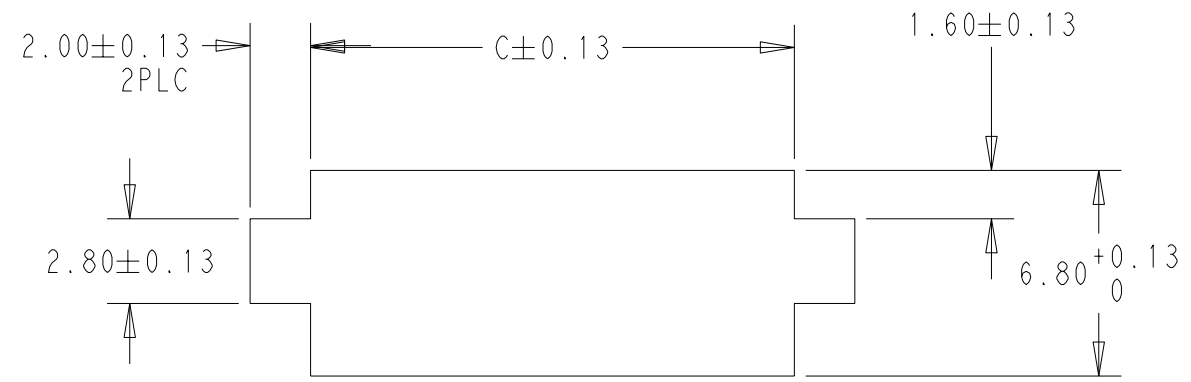

- 1. MATERIAL: NYLON UL94V-0, FLAME RETARDANT
- 2. PART COLOR VARIES IN TINT AND MAY APPEAR UNEVENLY MIXED
- 3. DIMENSIONS SHOWN REPRESENT PRODUCT IN DRY, AS MOLDED, CONDITION. ADDITIONAL 2% GROWTH DUE TO SUBSEQUENT MOISTURE ABSORPTION MAY OCCUR AND SHOULD BE ACCOUNTED FOR
- 4. ACCEPTS TE PIN CONTACTS: 2238007-[ ] OR 2238008-[ ]
- 5. HOUSING ACCEPTS OPTIONAL TPA:[ ]-1969443-[ ] OR [ ]-1969825-[ ]
- 6. RECOMMENDED MATING PART:[ ]-2338183-[ ]
- 7. PACKAGING: LOOSE PIECE.

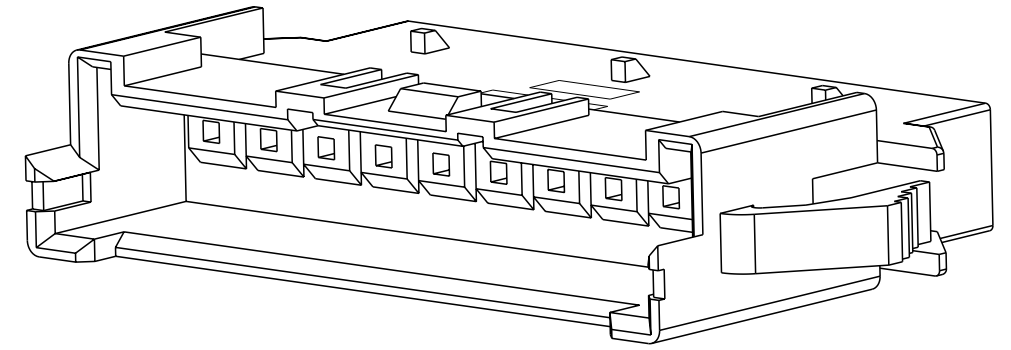
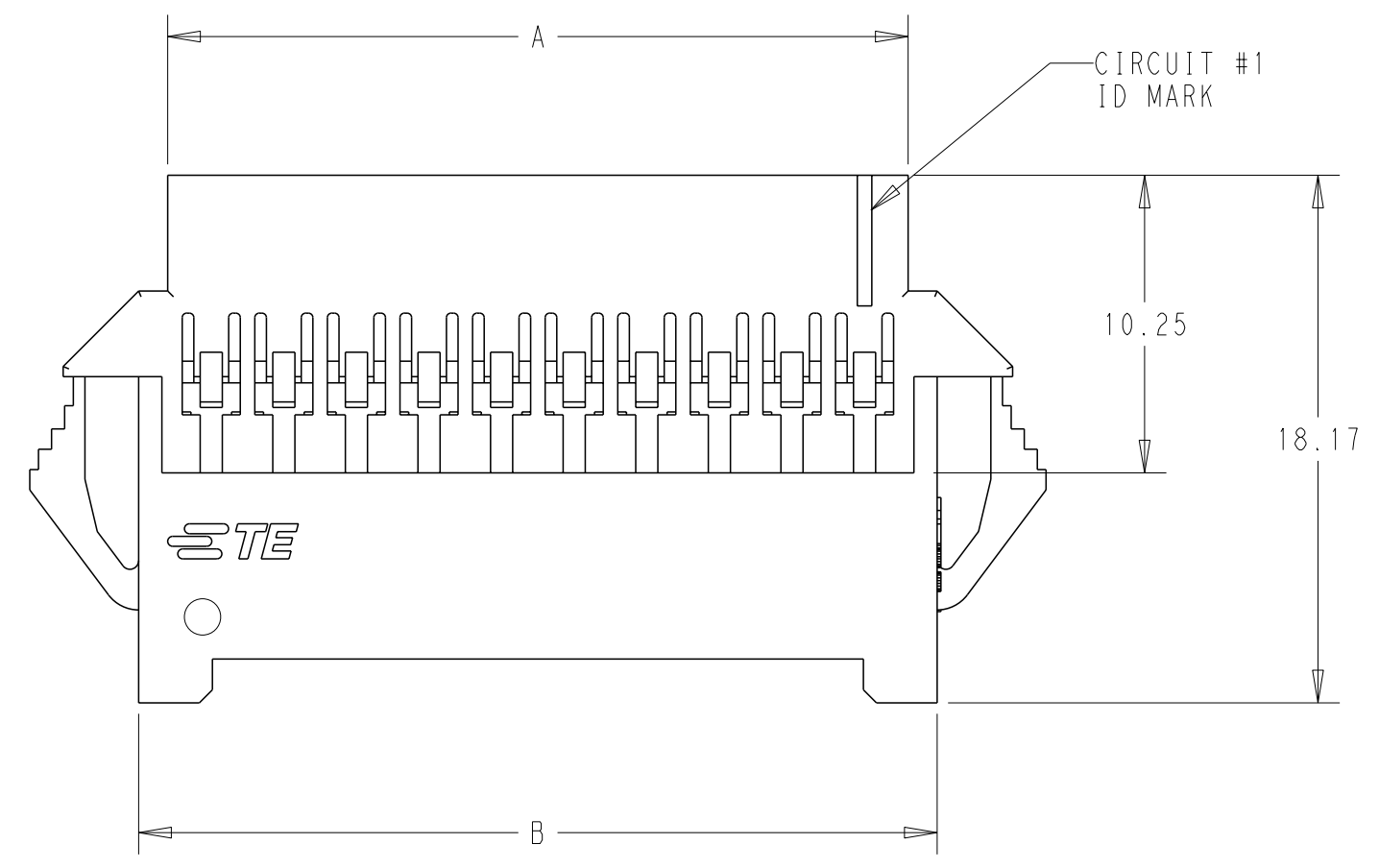
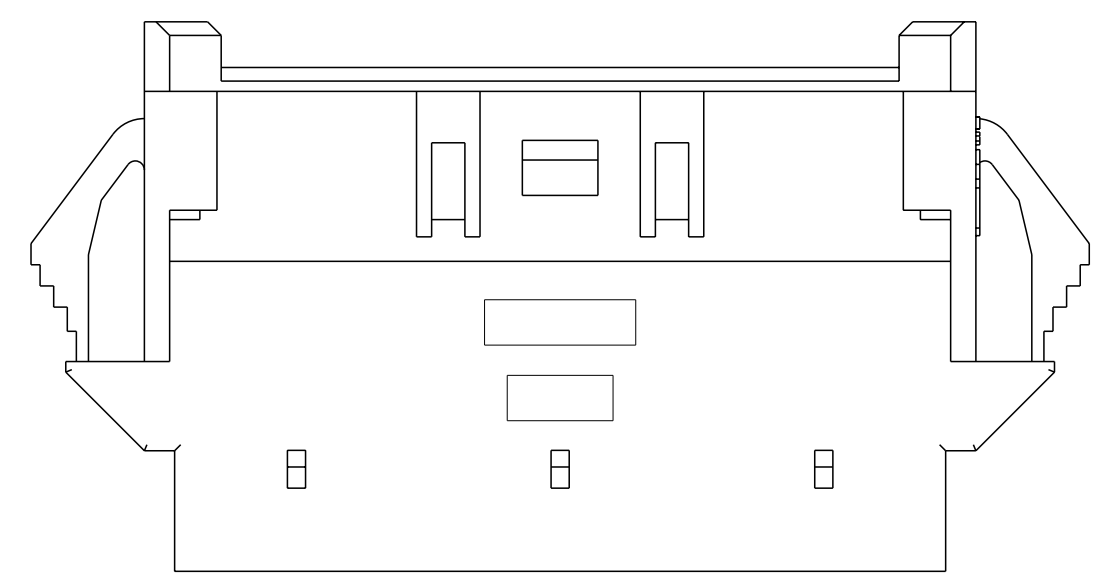
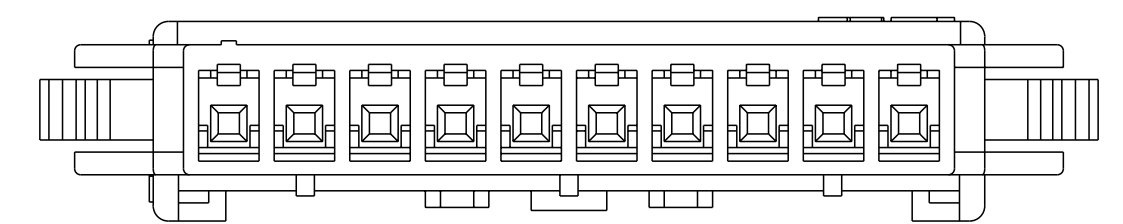
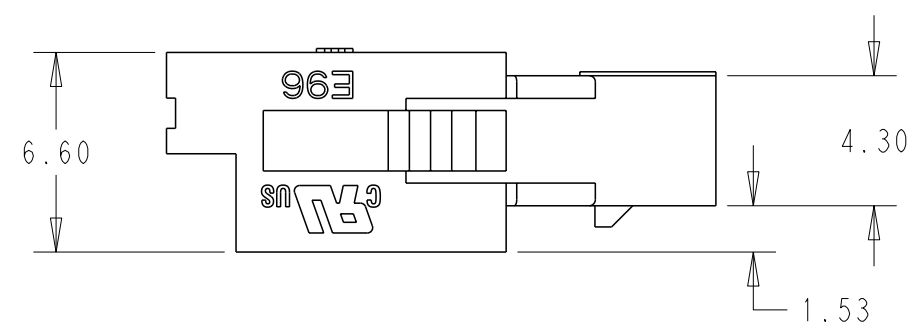
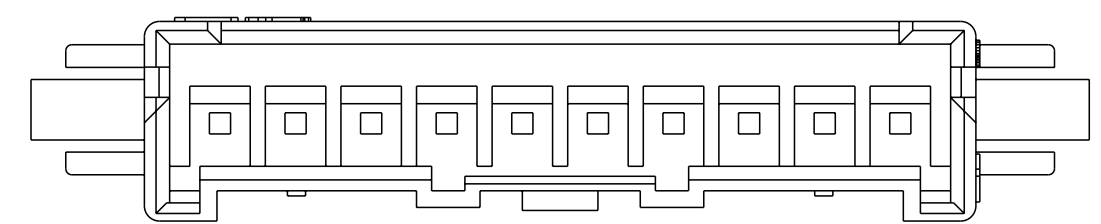

15	41.00	40.00	38.00	1-2349952-5	3-2349952-5	5-2349952-5	7-2349952-5	9-2349952-5
14	38.50	37.50	35.50	1-2349952-4	3-2349952-4	5-2349952-4	7-2349952-4	9-2349952-4
13	36.00	35.00	33.00	1-2349952-3	3-2349952-3	5-2349952-3	7-2349952-3	9-2349952-3
12	33.50	32.50	30.50	1-2349952-2	3-2349952-2	5-2349952-2	7-2349952-2	9-2349952-2
11	31.00	30.00	28.00	1-2349952-1	3-2349952-1	5-2349952-1	7-2349952-1	9-2349952-1
10	28.50	27.50	25.50	1-2349952-0	3-2349952-0	5-2349952-0	7-2349952-0	9-2349952-0
9	26.00	25.00	23.00	2349952-9	2-2349952-9	4-2349952-9	6-2349952-9	8-2349952-9
8	23.50	22.50	20.50	2349952-8	2-2349952-8	4-2349952-8	6-2349952-8	8-2349952-8
7	21.00	20.00	18.00	2349952-7	2-2349952-7	4-2349952-7	6-2349952-7	8-2349952-7
6	18.50	17.50	15.50	2349952-6	2-2349952-6	4-2349952-6	6-2349952-6	8-2349952-6
5	16.00	15.00	13.00	2349952-5	2-2349952-5	4-2349952-5	6-2349952-5	8-2349952-5
4	13.50	12.50	10.50	2349952-4	2-2349952-4	4-2349952-4	6-2349952-4	8-2349952-4
3	11.00	10.00	8.00	2349952-3	2-2349952-3	4-2349952-3	6-2349952-3	8-2349952-3
2	8.50	7.50	5.50	2349952-2	2-2349952-2	4-2349952-2	6-2349952-2	8-2349952-2
POS	DIM.C	DIM.B	DIM.A	PART NUMBER (RED COLOR)	PART NUMBER (BLUE COLOR)	PART NUMBER (BLACK COLOR)	PART NUMBER (YELLOW COLOR)	PART NUMBER (GREEN COLOR)

THIS DRAWING IS A CONTROLLED DOCUMENT.

DIMENSIONS: mm	TOLERANCES UNLESS OTHERWISE SPECIFIED:	DWN 18FEB2019 WARREN HUO	TE Connectivity CAP HOUSING, WTW, PANEL MOUNT ALL COLOR, UL VERSION, SINGLE ROW ECONOMY POWER 2.5
	0 PLC ±	CHK 18FEB2019 DANIEL ZHANG	
	1 PLC ±	APVD 18FEB2019 DANIEL ZHANG	
	2 PLC ±0.20	PRODUCT SPEC 108-2418	
MATERIAL	4 PLC ±	APVD 18FEB2019 DANIEL ZHANG	NAME
	ANGLES ±5°	APPLICATION SPEC 114-13315	SIZE
	FINISH	WEIGHT	CAGE CODE
CUSTOMER DRAWING		SCALE N/A	DRAWING NO
		SHEET 1 OF 2	RESTRICTED TO

Printed on 27 Dec 2023 09:40 (China Standard Time) from TE311234

THIS DRAWING IS UNPUBLISHED. RELEASED FOR PUBLICATION 20  
 © COPYRIGHT 20 BY - ALL RIGHTS RESERVED.

REVISIONS							
LOC	DIST	P	LTR	DESCRIPTION	DATE	DWN	APVD
-	-	-	-	SEE SHEET 1	-	-	-

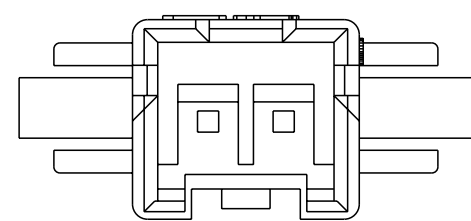

2 POSITION  
2349952-2

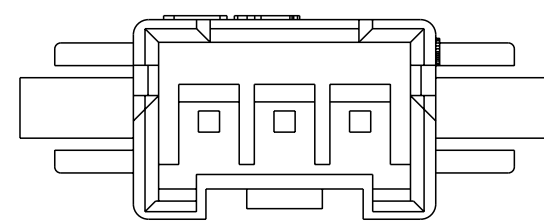

3 POSITION  
2349952-3

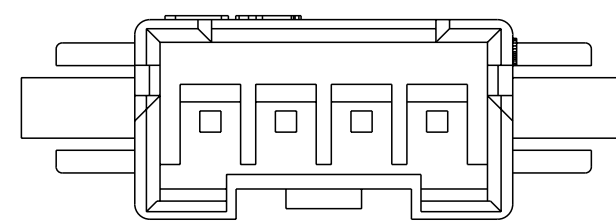

4 POSITION  
2349952-4

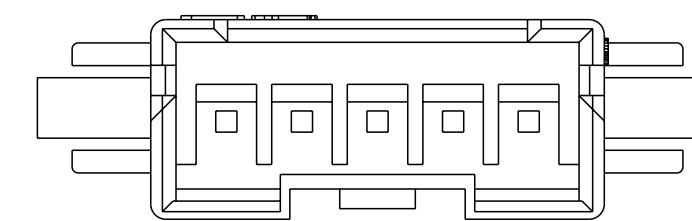

5 POSITION  
2349952-5

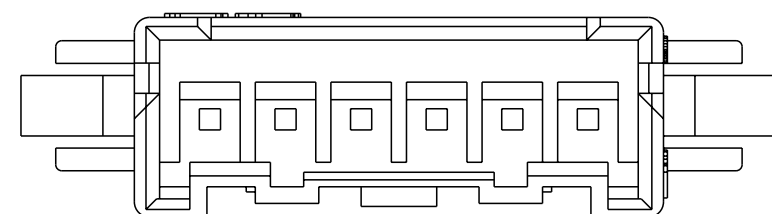

6 - 15 POSITION  
2349952-6 TO 1-2349952-5

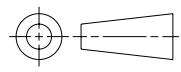
THIS DRAWING IS A CONTROLLED DOCUMENT.		DWN 18FEB2019 WARREN HUO	 TE Connectivity	
DIMENSIONS: mm		CHK 18FEB2019 DANIEL ZHANG		
TOLERANCES UNLESS OTHERWISE SPECIFIED:		APVD 18FEB2019 DANIEL ZHANG	NAME CAP HOUSING, WTW, PANEL MOUNT ALL COLOR, UL VERSION, SINGLE ROW ECONOMY POWER 2.5	
		PRODUCT SPEC 108-2418	SIZE A2	CAGE CODE 00779
MATERIAL		APPLICATION SPEC 114-13315	DRAWING NO C-2349952	
FINISH		WEIGHT -	RESTRICTED TO -	
-		CUSTOMER DRAWING	SCALE N/A	SHEET 2 OF 2 REV A

Printed on 27 Dec 2023 09:40 (China Standard Time) from TE311234