

TB6640AFTG

Full-Bridge DC Motor Driver IC

The TB6640AFTG is a full-bridge DC motor driver with DMOS output transistors.

The low ON-resistance DMOS process and PWM control enables driving DC motors with high thermal efficiency.

Four operating modes are selectable via IN1 and IN2: clockwise (CW), counterclockwise (CCW), Short Brake and Stop.

Features

- Power supply voltage : 40 V (max)
- Output current : 3 A (max)
- Direct PWM control
- PWM constant-current control
- CW/CCW/Short Brake/Stop
- Overcurrent shutdown circuit (ISD)
- Thermal shutdown circuit (TSD)
- Undervoltage lockout circuit (LVD)
- Dead time for preventing shoot-through current

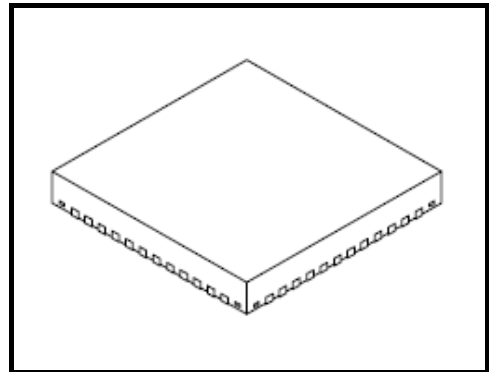

Weight: 0.1g (typ.)

Block Diagram (application circuit example)

The application circuits shown in this document are provided for reference purposes only. Thorough evaluation is required, especially at the mass production design stage.

Toshiba does not grant any license to any industrial property rights by providing these examples of application circuits.

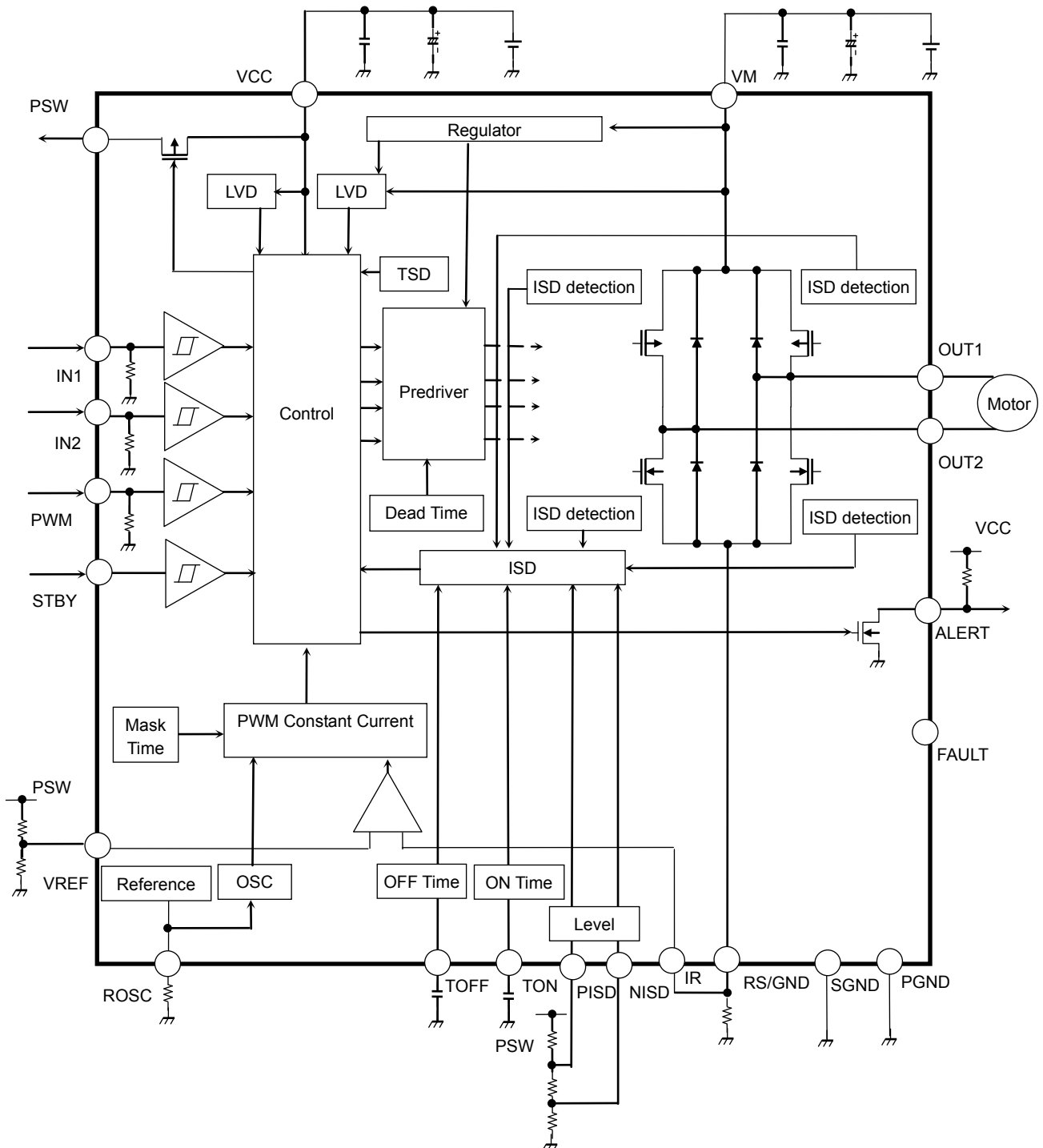

Pin Functions

Pin No.	Pin Name	Functional Description
1	N.C.	No-connect
2	PWM	PWM input pin
3	N.C.	No-connect
4	IN1	Control signal input pin 1
5	N.C.	No-connect
6	IN2	Control signal input pin 2
7	N.C.	No-connect
8	STBY	Standby input pin
9	NISD	Program pin for overcurrent detection control for Nch
10	PISD	Program pin for overcurrent detection control for Pch
11	ROSC	Resistor control pin for reference frequency
12	N.C.	No-connect
13	N.C.	No-connect
14	VCC	Power supply voltage pin
15	VCC	Power supply voltage pin
16	N.C.	No-connect
17	N.C.	No-connect
18	FAULT	TEST pin (The pin should be open.)
19	N.C.	No-connect
20	VM	Power supply voltage pin for motor
21	VM	Power supply voltage pin for motor
22	N.C.	No-connect
23	TOFF	Program pin for OFF time of overcurrent detection
24	N.C.	No-connect
25	N.C.	No-connect
26	OUT2	Output pin 2
27	OUT2	Output pin 2
28	N.C.	No-connect
29	PGND	Connect pin for power ground
30	RS/GND	Detection resistor pin for PWM constant-current control/ Power ground pin
31	RS/GND	Detection resistor pin for PWM constant-current control/ Power ground pin
32	IR	Detection pin for constant current
33	N.C.	No-connect
34	OUT1	Output pin 1
35	OUT1	Output pin 1
36	N.C.	No-connect
37	N.C.	No-connect
38	TON	Program pin for ON time of overcurrent detection
39	N.C.	No-connect
40	ALERT	Error detection output pin
41	N.C.	No-connect

42	N.C.	No-connect
43	SGND	Small signal ground pin
44	SGND	Small signal ground pin
45	N.C.	No-connect
46	VREF	Supply voltage pin for PWM constant-current control
47	PSW	Output pin for VCC
48	N.C.	No-connect

Pin Assignment (top view)

Note: Design the pattern in consideration of the heat design because the back side has the role of heat radiation.
 (The back side should be connected to GND because it is connected to the back of the chip electrically.)

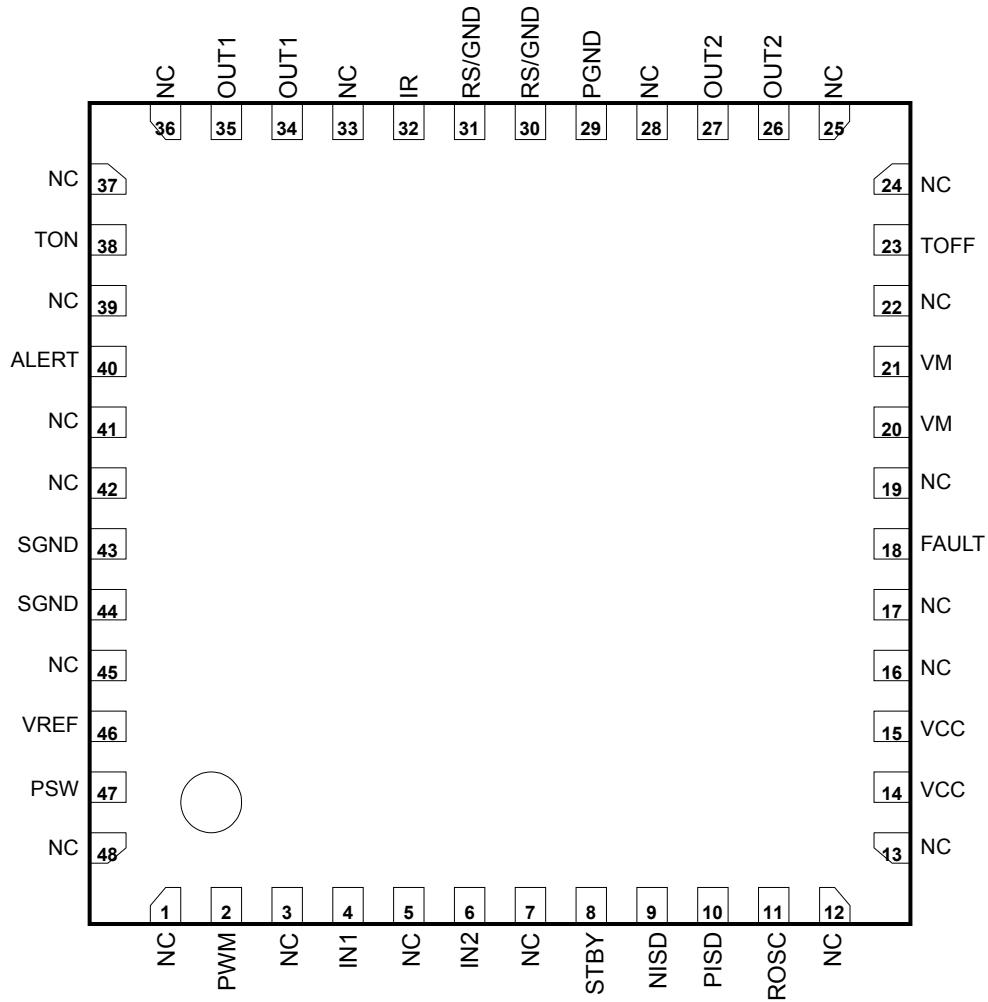

Absolute Maximum Ratings (Ta = 25°C)

The absolute maximum ratings of a semiconductor device are a set of ratings that must not be exceeded, even for a moment. Do not exceed any of these ratings.

Exceeding the rating (s) may cause the device breakdown, damage or deterioration, and may result injury by explosion or combustion.

Characteristics	Symbol	Rating	Unit	Appropriate pin	Remarks
Power supply voltage	VM	40	V	VM	
	VCC	6	V	VCC	
Output voltage	VO1	40	V	OUT1,OUT2	
	VO2	6	V	ALERT,PSW	
Output current	IO1 peak	3	A	OUT1,OUT2	Use the IC not to exceed 3A (Rating value) including parasitic diode of output transistor (DMOS).
	IO2 peak	1	mA	ALERT,PSW	
Input voltage	VIN	-0.3 to 6	V	IN1,IN2,PWM,STBY,VREF	
Power dissipation	PD	2.5	W	—	35 mm × 50 mm × 1.6 mm CEM-3 double-sided, Cu dimension: 50%
Operating temperature	Topr	-40 to 85	°C	—	
Storage temperature	Tstg	-55 to 150	°C	—	

Operating Ranges

Characteristics	Symbol	Min.	Typ.	Max.	Unit	Appropriate pin	Remarks
Power supply voltage	VMopr	4.5	24	38	V	VM	
	VCCopr1	4.5	5	5.5	V	VCC	In case of using constant current PWM control.
	VCCopr2	3.0	5	5.5	V	VCC	In case of not using constant current PWM control.
Input voltage of VREF and IR	VREFopr	0	—	0.5	V	VREF,IR	
PWM frequency	fPWMopr	—	100	—	kHz	PWM, IN1, IN2	Reference value The switching characteristic of the output transistor strains the frequency.
Output current	IO (Ave)	—	1	—	A	—	Reference value The average output current shall be increased or decreased depending on usage conditions such as ambient temperature and IC mounting method). Use the average output current so that the junction temperature of 150°C (Tj) and the absolute maximum output current rating are not exceeded.

Electrical Characteristics (unless otherwise specified, Ta = 25°C, VM = 24 V, and VCC = 5 V)

Characteristics		Symbol	Test Condition	Min	Typ.	Max	Unit
Power supply voltage		IM	VM operation mode	—	1.3	5	mA
		ICC	VCC operation mode	—	3	7	mA
		IMSTBY	VM standby mode	—	—	1	μA
		ICCSTBY	VCC standby mode	—	—	1	μA
IN1 pin IN2 pin PWM pin	Input voltage	VINH	—	2	—	5.5	V
		VINL	—	0	—	0.7	
	Hysteresis voltage	VINHYS	—	—	0.2	—	
	Input current	IINH	VIN = 5 V	—	20	30	μA
IINL		VIN = 0 V	—	—	1		
STBY pin	Input voltage	VINHSB	—	2	—	5.5	V
		VINLSB	—	0	—	0.7	
	Hysteresis voltage	VSBHYS	—	—	0.2	—	V
	Input current	IINSB	—	—	—	1	μA
	Output response time 1	TSTBY1	STBY = H → L (Reference value *)	—	0.1	—	μs
	Output response time 2	TSTBY2	STBY = L → H (Reference value *)	—	16	30	μs
OUT1 pin OUT2 pin	Output ON resistance	RONU	Io = -2.5 A	—	0.6	0.9	Ω
		RONL	Io = 2.5 A	—	0.4	0.6	
	Output leakage current	ILU	VM = 40 V, VOUT = 0 V	-1	0	—	μA
		ILL	VM = VOUT = 40 V	—	0	1	
	Diode forward voltage	VFU	Io = 2.5 A	—	1.3	1.7	V
		VFL	Io = -2.5 A	—	1.15	1.5	
ALERT pin	Output LOW voltage	VALLO	IAlert = 1 mA	—	0.02	0.4	V
	Output leakage current	IALLE	VALERT = 5.5 V	—	0	1	μA
TON pin	TON voltage	VTON	—	1.1	1.25	1.4	V
	TON charge current	ITON	—	30	110	200	μA
	TON time	TTON	TON: 470 pF (Reference value *)	2.3	5.35	9.4	μs
TOFF pin	TOFF voltage	VTOFF	—	1.1	1.25	1.4	V
	TOFF charge current	ITOFF	—	0.3	1.25	2.5	μA
	TOFF time	TTOFF	TOFF: 1000 pF (Reference value *)	0.4	1	1.6	ms
PISD pin	PISD over current set	IPISD	PISD = 3 V (Reference value *)	4	5	7	A
NISD pin	NISD over current set	INISD	NISD = 3 V (Reference value *)	4	5	6	A
ROSC pin	OSC frequency	fOSC	ROSC = 24 kΩ (Reference value *)	8	10	12	MHz
	Constant current PWM short brake time	TSHB	ROSC = 24 kΩ	13.3	16	20	μs
	Constant current PWM minimum charge width	TMIN	ROSC = 24 kΩ (Reference value *) VREF=0.25V	1.2	1.7	2.2	μs
VREF pin	Input current	IVREF	—	-0.5	—	0.5	μA
IR pin	Constant current PWM offset voltage	VIROFS	VREF = 0 V IR (Reference value *)	-10	0	10	mV
PSW pin	Output ON resistance	PSWRON	IPSW = -1 mA	—	25	75	Ω
	Output leakage current	PSWIL	VPSW = 0 V, VCC = 5.5 V	—	0	1	μA
Operation temperature of thermal shutdown circuit		TSDON	(Reference value *)	—	170	—	°C

Characteristics	Symbol	Test Condition	Min	Typ.	Max	Unit
Recover temperature of thermal shutdown circuit	TSDOFF	(Reference value *)	—	130	—	°C
Hysteresis temperature width of thermal shutdown circuit	TSDHYS	(Reference value *)	—	40	—	°C
Detect voltage for VM decreasing	VMD	—	—	4.0	—	V
Recover voltage for VM decreasing	VMR	—	—	4.2	—	V
Hysteresis voltage width for VM decreasing	VMHYS	(Reference value *)	—	0.2	—	V
Detect voltage for VCC decreasing	VCCD	—	—	2.7	—	V
Recover voltage for VCC decreasing	VCCR	—	—	2.8	—	V
Hysteresis voltage width for VCC decreasing	VCCHYS	(Reference value *)	—	0.1	—	V

*: Toshiba does not implement testing before shipping.

Characteristics of Power Dissipation (Reference value)

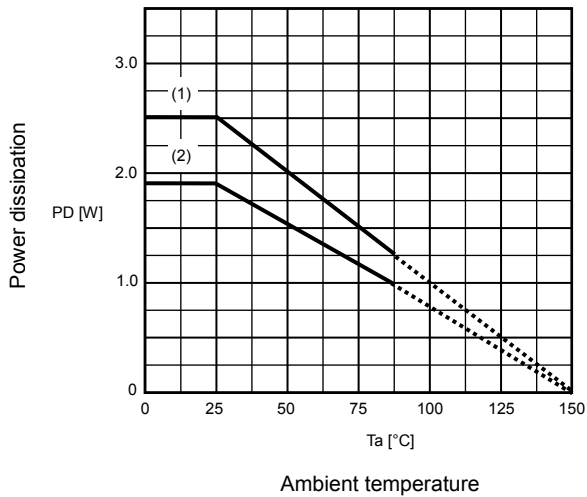

1) When mounted on the board: $\theta_{ja} = 49.3^{\circ}\text{C}/\text{W}$ (35 mm × 50 mm × 1.6 mm CEM-3(thermal conductivity; 1.0 W/m·K) Double-sided Cu dimension: 50%)

2) When mounted on the board: $\theta_{ja} = 65.7^{\circ}\text{C}/\text{W}$ (35 mm × 50 mm × 1.6 mm CEM-3(thermal conductivity; 1.0 W/m·K) Double-sided Cu dimension: 25%)

I/O Equivalent Circuits

The equivalent circuit diagrams may be simplified or some parts of them may be omitted for explanatory purposes.

Pin name	I/O Internal Circuit	Pin name	I/O Internal Circuit
IN1 IN2 PWM	<p>IN1 IN2 PWM 250 kΩ(Typ.)</p>	ALERT	<p>ALERT</p>
STBY	<p>STBY</p>	PSW	<p>VCC PSW VCC</p>
ROSC	<p>VCC VCC ROSC</p>	TON TOFF	<p>VCC VCC TON TOFF</p>
IR VREF	<p>VREF VCC IR</p>	PISD NISD	<p>VCC PISD NISD</p>
OUT1 OUT2 RS/GND	<p>VM OUT1(OUT2) RS/GND</p>		

Functional Description

The equivalent circuit diagrams may be simplified or some parts of them may be omitted for explanatory purposes.

Timing charts may be simplified for explanatory purposes.

1. Input/Output Functions

Input				Output		Mode
STBY	IN1	IN2	PWM	OUT1	OUT2	
H	H	H	H	L	L	Short brake
			L	L	L	Short brake
	L	H	H	L	L	Short brake
			L	L	H	CCW/CW
	H	L	H	L	L	Short brake
			L	H	L	CW/CCW
L	L	—	OFF (Hi-Z)	OFF (Hi-Z)	Stop	
L	—	—	—	OFF (Hi-Z)	OFF (Hi-Z)	Standby

2. Protective Operation Alert Output (ALERT pin)

The ALERT pin behaves as an open-drain output and provides a high-impedance state on output being pulled up by a resistor externally wired.

The output is Low when the TB6640AFTG performs a normal operation. The output is High when the operation is in the states of the standby mode, the thermal shutdown circuit (TSD), the overcurrent detection circuit (ISD), and the under voltage lockout (LVD).

3. VCC Output (PSW pin)

PSW pin behaves as an open-drain output and provides VCC in the normal operation.

The output is High when the operation is in the states of standby mode and the under voltage lockout (LVD). The standby power requirement can be reduced by using it as a set voltage of the external part because it synchronizes with the standby mode.

4. Standby Mode

The operation state moves to the standby mode when STBY pin outputs Low. The power consumption can be reduced in this mode.

Standby mode can also release the thermal shutdown circuit (TSD) and the overcurrent detection circuit (ISD) forcedly.

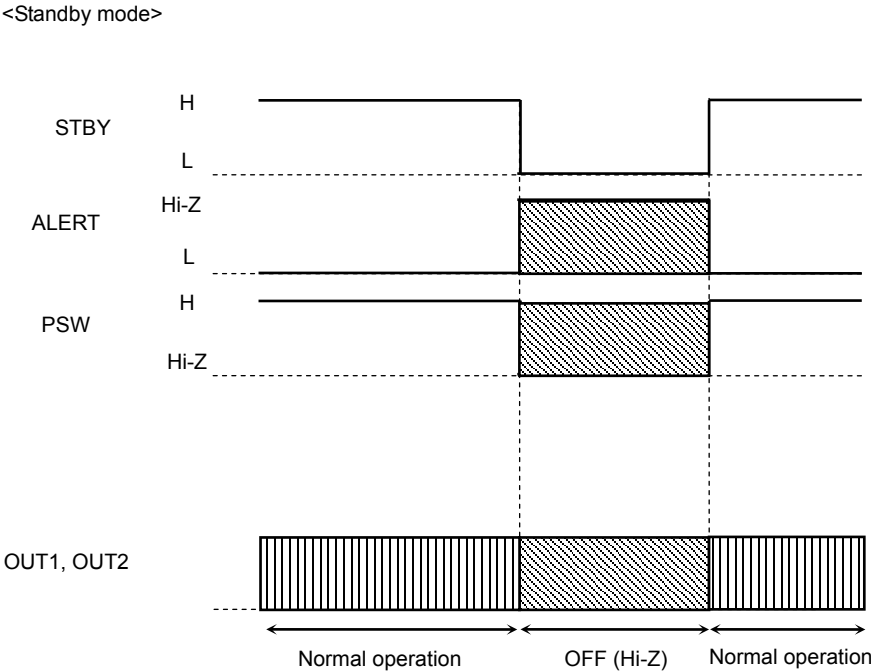

5. Undervoltage Lockout Circuit (LVD)

The TB6640AFTG incorporates an undervoltage lockout circuit for VM and VCC.

When VM drops under 4.0 V (typ.), all the outputs are turned off (Hi-Z). The LVD circuit has a hysteresis of 0.2 V (typ.); the TB6640AFTG resumes the normal operation at 4.2 V (typ.).

When VCC drops under 2.7 V (typ.), all the outputs are turned off (Hi-Z). The LVD circuit has a hysteresis of 0.1 V (typ.); the TB6640AFTG resumes the normal operation at 2.8 V (typ.).

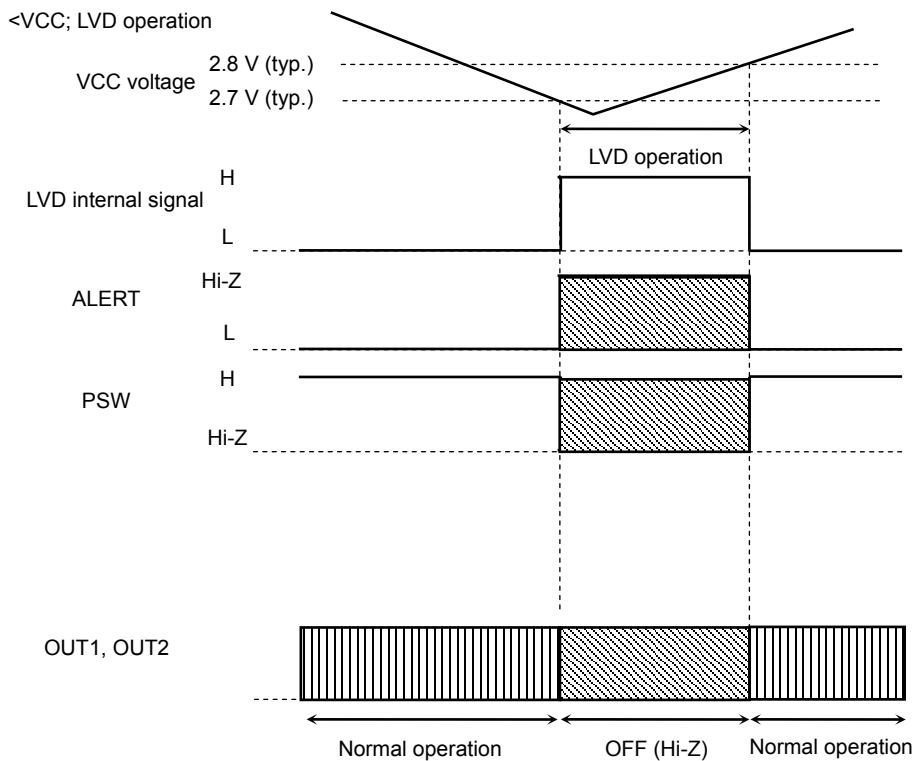
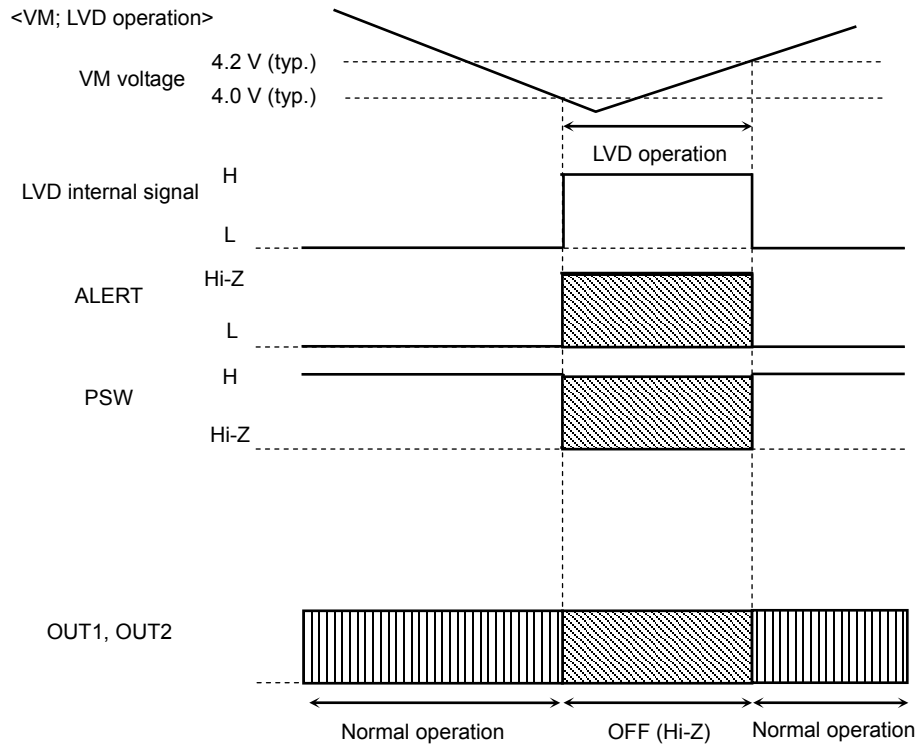

6. Thermal Shutdown Circuit (TSD)

The TB6640AFTG incorporates a thermal shutdown circuit. If the junction temperature (T_j) exceeds 170°C (typ.), all the outputs are turned off (Hi-Z).

The TB6640AFTG has a hysteresis of 40°C (typ.); the TB6640AFTG resumes the normal operation automatically when both of the following conditions are provided; the temperature is 130°C (typ.) or less. The operation stops for more than toff.

Stop time (toff) can be programmed by the capacitor of TOFF pin.

In order not to resume the normal operation automatically after the thermal shutdown mode, connect TOFF pin to the GND.

The TB6640AFTG resumes the normal operation by transferring to the standby mode (STBY pin = Low).

<TSD operation>

TOFF: Connect to capacitor

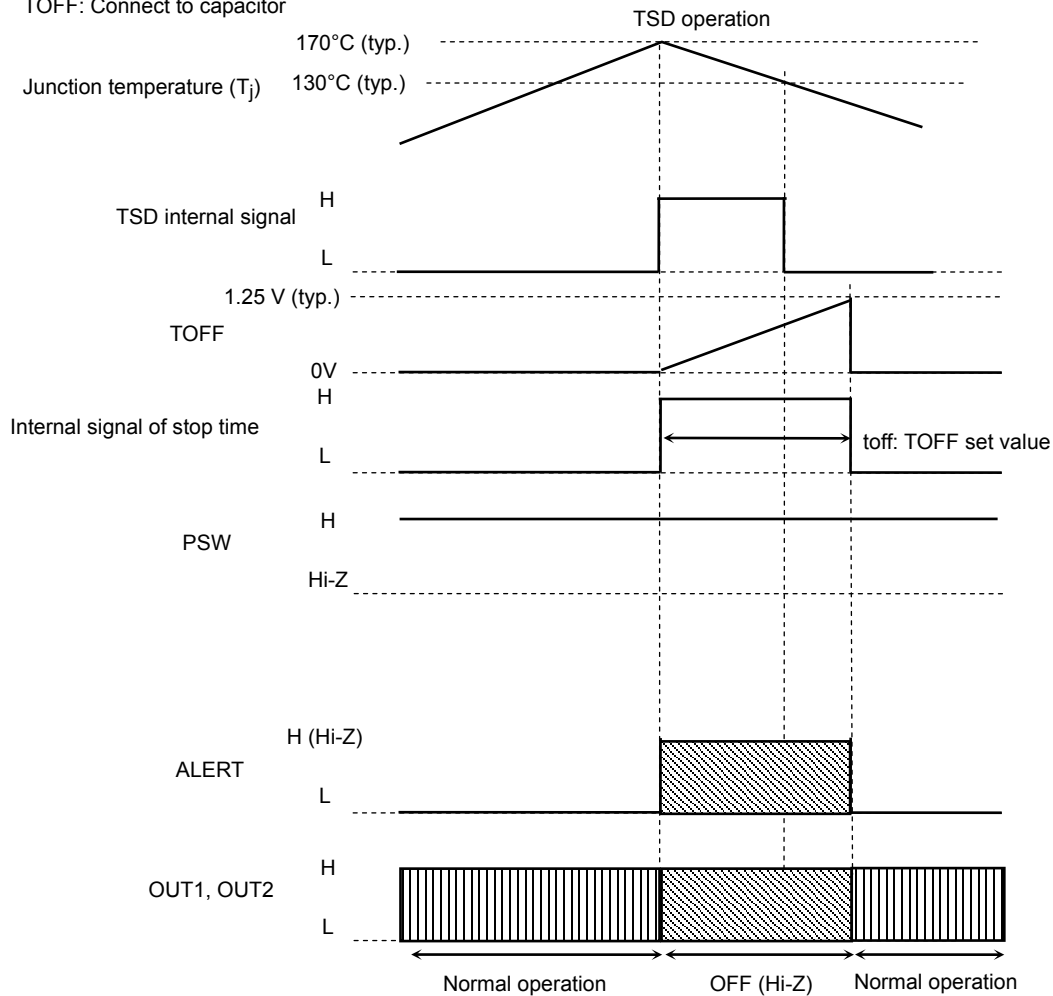

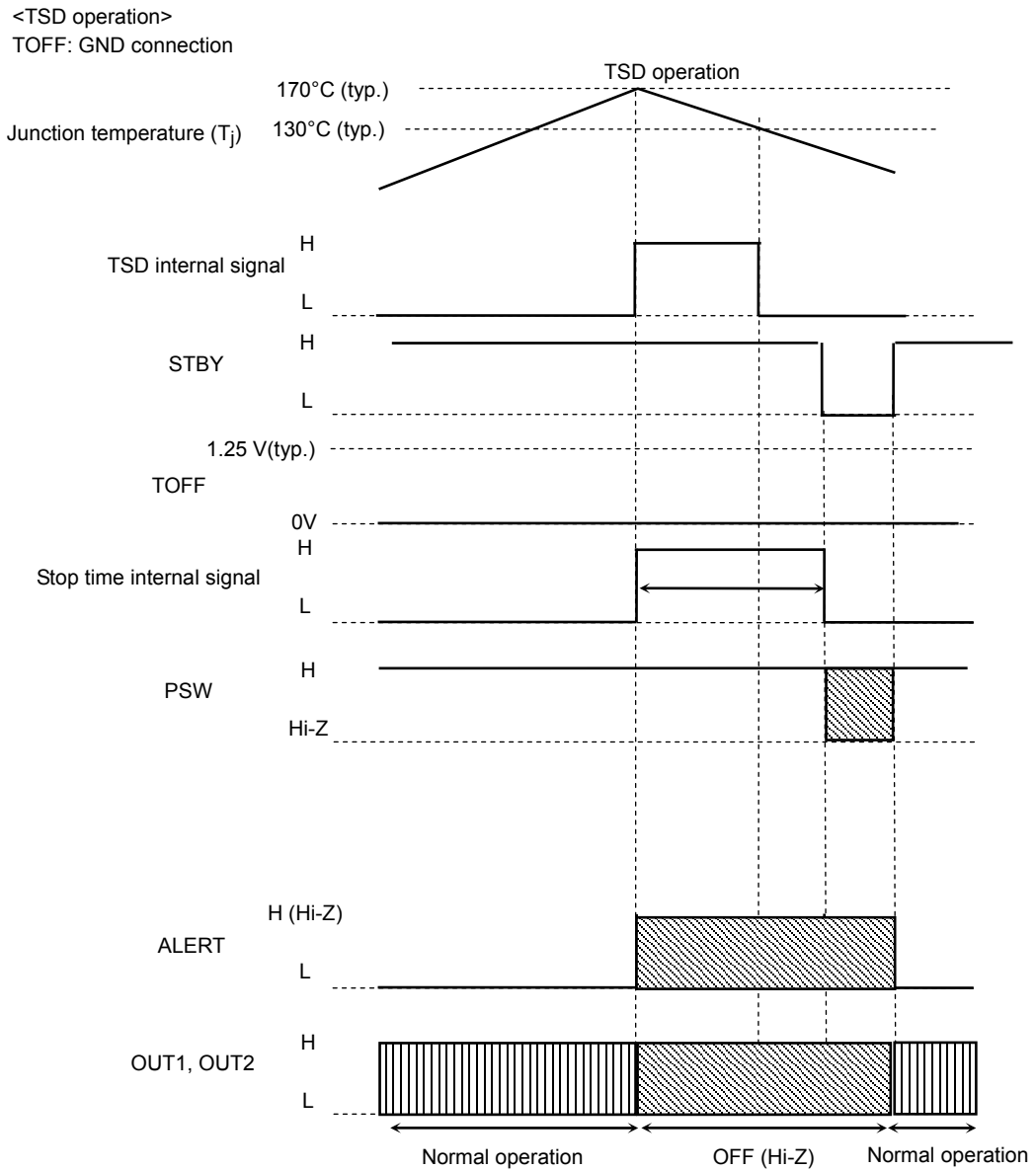

Note: The TSD circuit is activated if the absolute maximum junction temperature rating (T_j) of 150°C is violated. Note that the circuit is provided as an auxiliary only and does not necessarily provide the IC with a perfect protection from any kind of damages.

7. Overcurrent Shutdown Circuit (ISD)

The TB6640AFTG incorporates overcurrent detection (ISD) circuits monitoring the current that flows through each of all the four output power transistors.

The detection current is programmable by setting input voltage of NISD pin and PISD pin. If the overcurrent flowing through any one of the ISD circuit flows beyond the detected time threshold, outputs of OUT1 and OUT2 are turned off (Hi-Z) and that of ALERT is programmed High (Hi-Z).

Then, the TB6640AFTG resumes the normal operation automatically after stop time (toff) has passed.

The detection time (ton) is controllable through the external resistor of the TON pin.

The stop time (toff) is controllable through the capacitor of the TOFF pin.

In order not to resume the normal operation automatically after detection of overcurrent, connect TOFF pin to the GND.

The TB6640AFTG resumes the normal operation by transferring to the standby mode (STBY pin = Low).

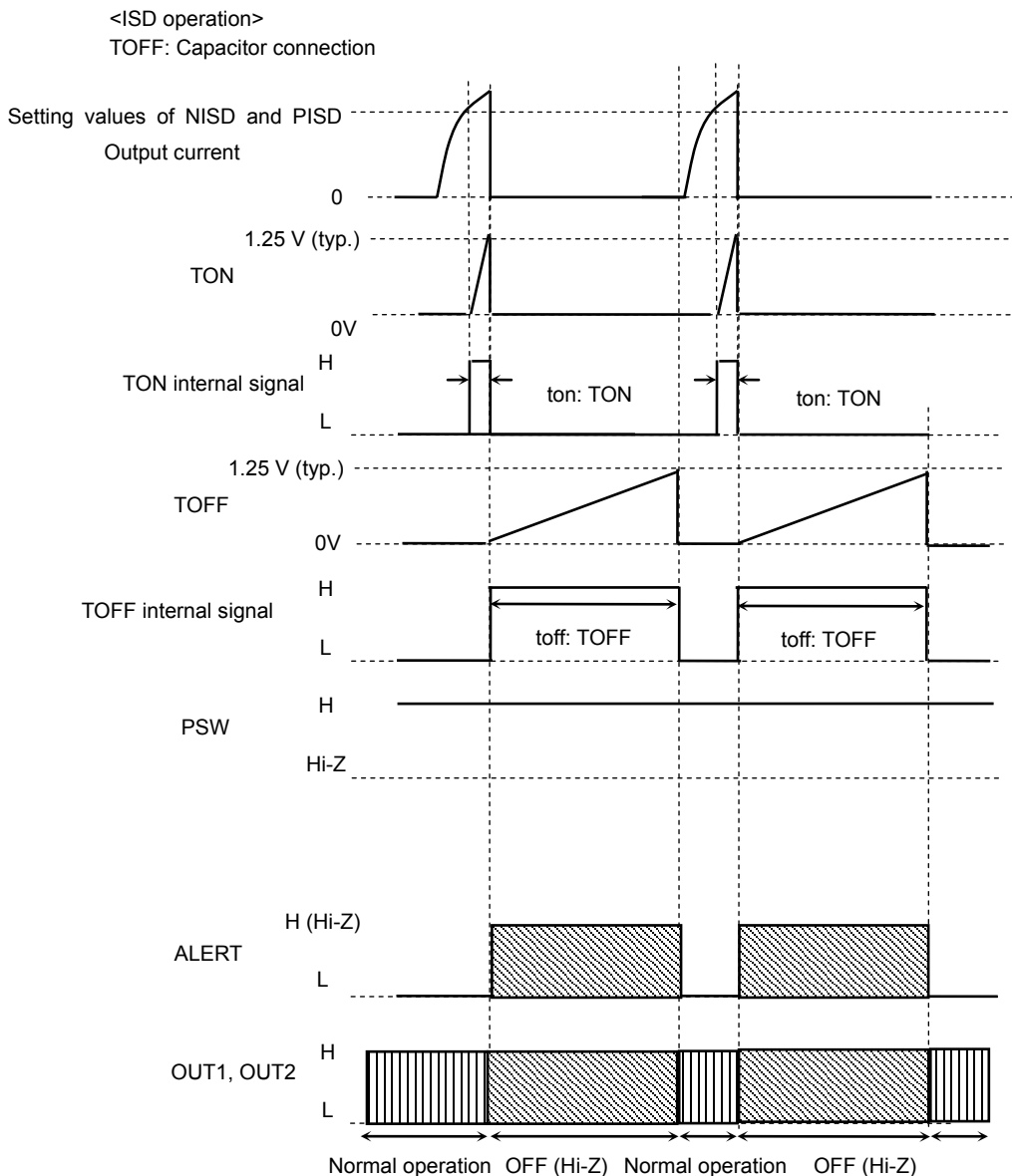

Note: The ISD circuit is activated if the absolute maximum current rating is violated. Note that the circuit is provided as an auxiliary only and does not necessarily provide the IC with a perfect protection from damages due to overcurrent caused by power fault, ground fault, load-short and the like.

8. Direct PWM Control

The motor rotation speed is controllable by the PWM input sent through the PWM pin.

It is also possible to control the motor rotation speed by sending in the PWM signal through not the PWM pin but the IN1 and IN2 pins.

When the motor drive is controlled by the PWM input, the TB6640AFTG repeats operating in Normal Operation mode and Short Brake mode alternately.

For preventing the shoot-through current in the output circuit caused by the upper and lower power transistors being turned on simultaneously, the dead time is internally generated at the time the upper and lower power transistors switches between on and off.

This eliminates the need of inserting Off time externally; thus the PWM control with synchronous rectification is enabled.

Note that inserting Off time externally is not required on operation mode changes between CW and CCW, and CW (CCW) and Short Brake, again, because of the dead time generated internally.

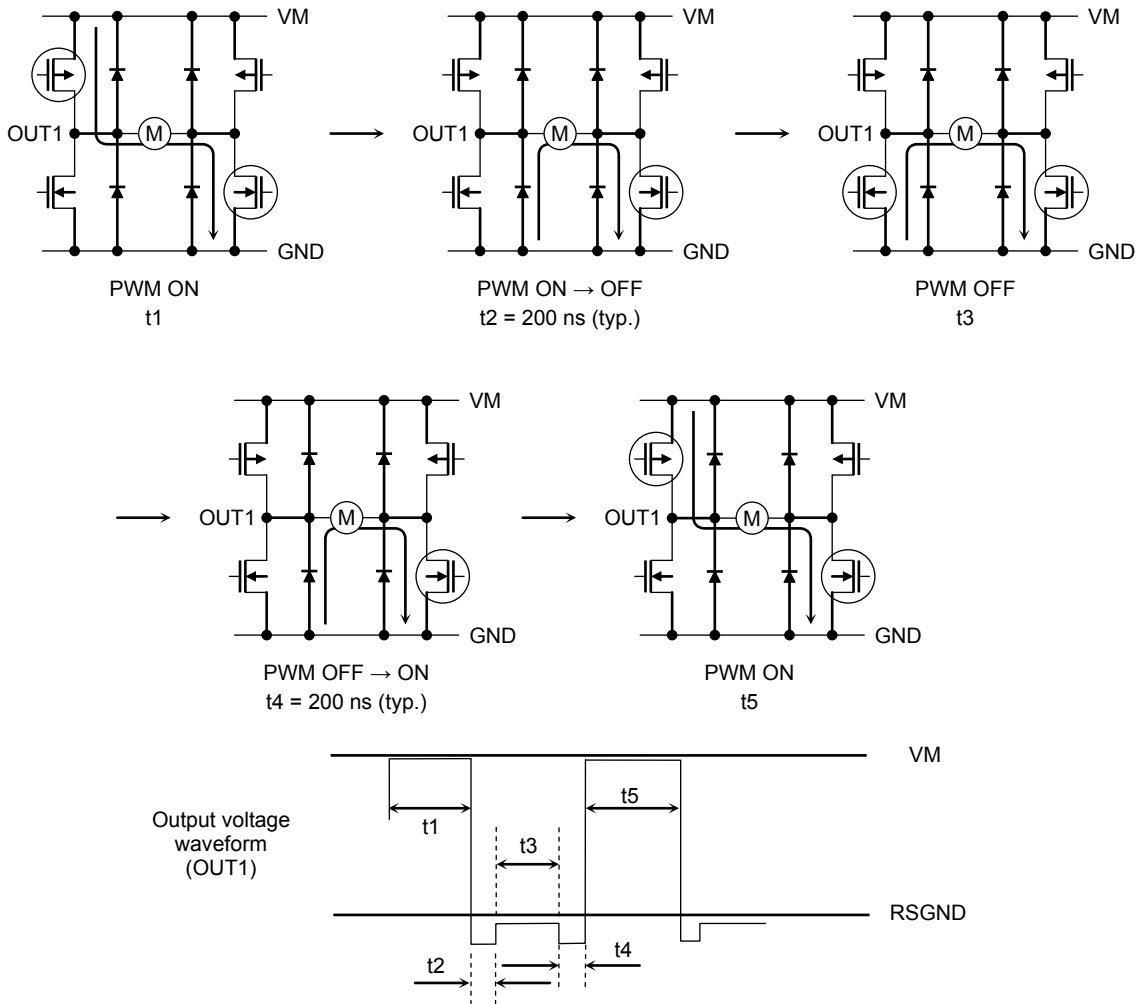

9. Output Circuit

The switching characteristics of the output transistors of the OUT1 and OUT2 pins are as shown below:

Ta = 25°C, VM = 24 V, VCC= 5V, No load

Characteristic	Typ. (Reference value*)	Max. (Reference value)	Unit
t _{pLH}	260	500	ns
t _{pHL}	260	500	
t _r	50	100	
t _f	50	100	

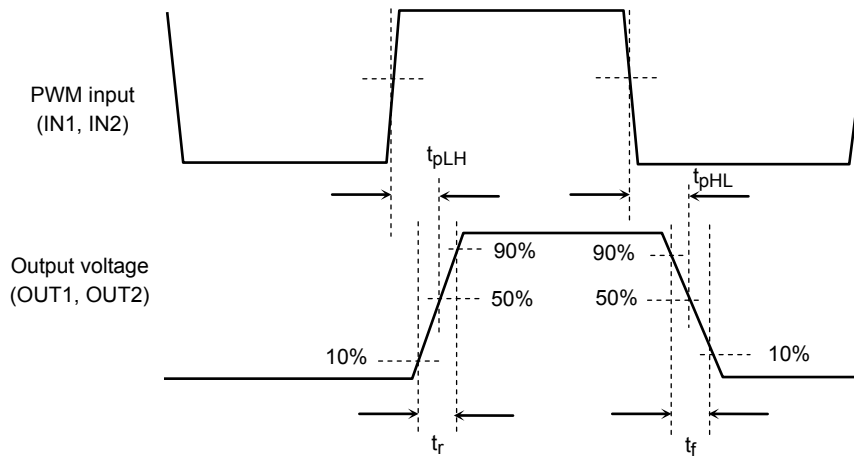

10. PWM Constant-Current Control

The TB6640AFTG uses a peak current detection technique to keep the output current constant by applying constant voltage through the VREF pin. When running in Discharge mode, the TB6640AFTG powers the motor to operate in Short-brake mode (OUT1 = OUT2 = Low).

(1) PWM constant-current control programming

The peak current upon the constant-current operation is determined by applying voltage on the VREF pin. The peak current value is calculated by the following equation:

$$I_O = V_{REF}/R \quad [A]$$

(2) PWM constant-current programming time

Reference oscillation frequency is determined by connecting the resistance to the ROSC pin.

Short brake time (discharging time) corresponds to 39 internal clocks of four cycles of OSC signal and adding analog delay time.

Minimum charge width corresponds to 13 internal clocks of OSC signal and adding analog delay time.

Short brake time = $4/f_{OSC} \times 39$ internal clocks + A A: Analog delay time (400 ns (typ.))

Minimum charge width = $1/f_{OSC} \times 13$ internal clocks + B B: Analog delay time (350 ns (typ.))

Ex.: $f_{OSC} = 10$ MHz; Short brake time = 16 μ s (typ.) Minimum charge width = 1.7 μ s (typ.)

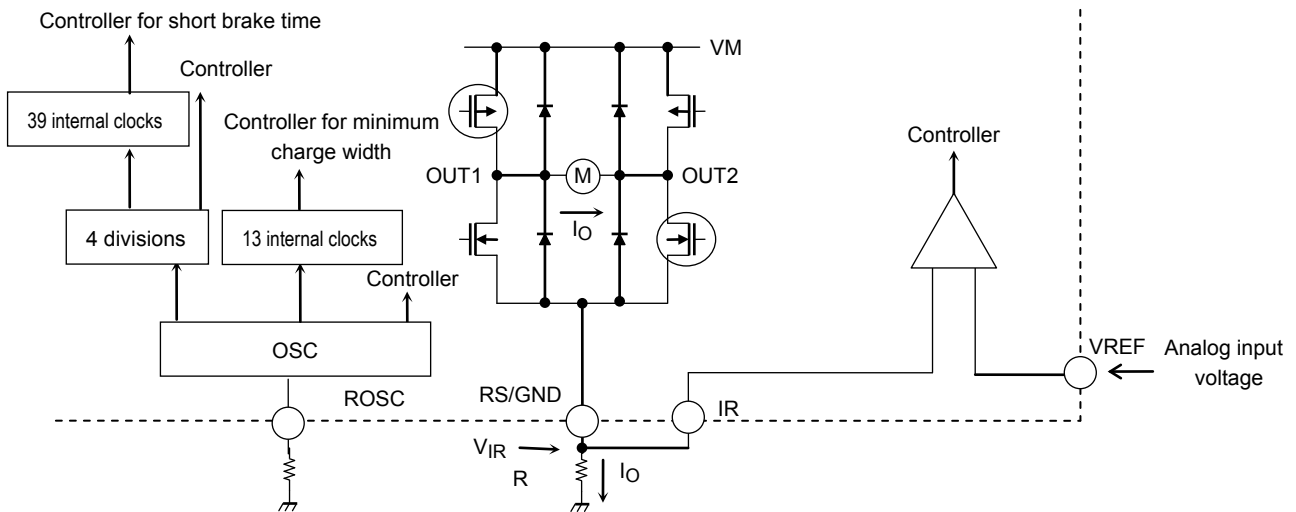

(3) Constant-current chopping

The TB6640AFTG enters Discharge mode when V_{IR} reaches the predetermined voltage (V_{REF}).

After a lapse of 39 internal clocks + A which is generated by the 4 cycles of OSC signal, the TB6640AFTG shifts to Charge mode.

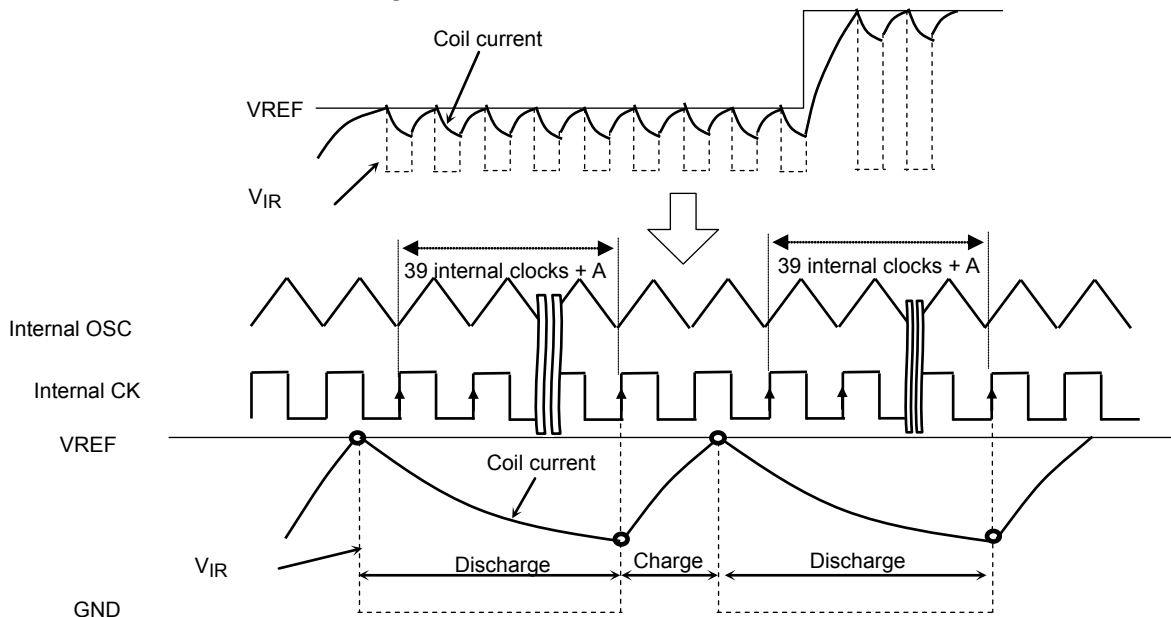

(4) Operation on change of predetermined current value (when in Discharge mode)

The TB6640AFTG enters Discharge mode as V_{IR} reaches the predetermined voltage (V_{REF}) and then transits to Charge mode after 39 internal clocks + A. However, if $V_{IR} > V_{REF}$ at the time, the TB6640AFTG goes back to Discharge mode. If $V_{IR} < V_{REF}$ after another 39 internal clocks + A, then the TB6640AFTG enters Charge mode and stays until V_{IR} reaches V_{REF} .

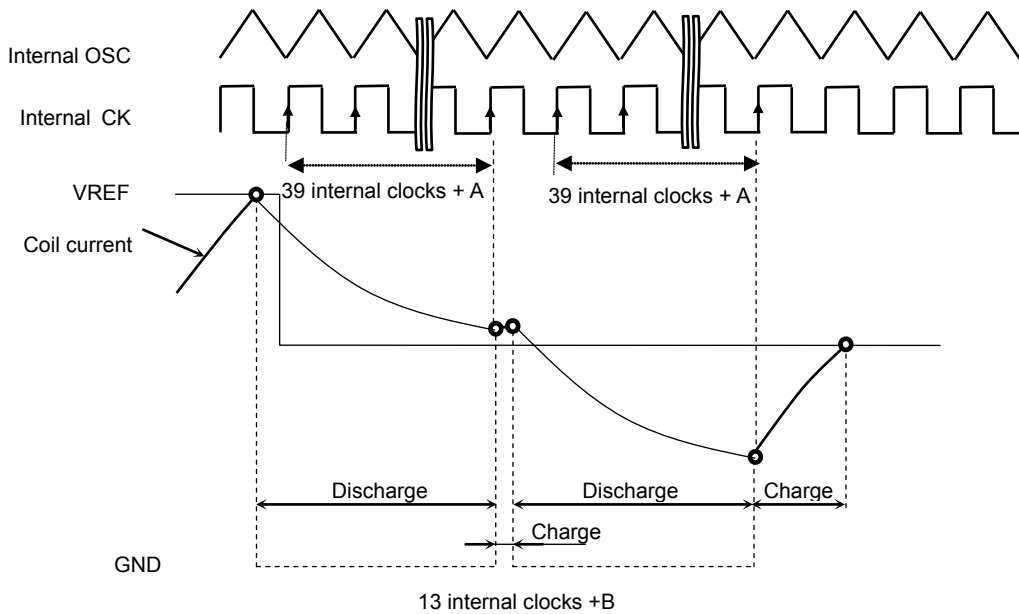

(5) Operation on change of predetermined current value (when in Charge mode)

Even though V_{REF} reaches the predetermined current value, Discharge mode continues for 39 internal clocks + A after that. And then Charge mode is entered.

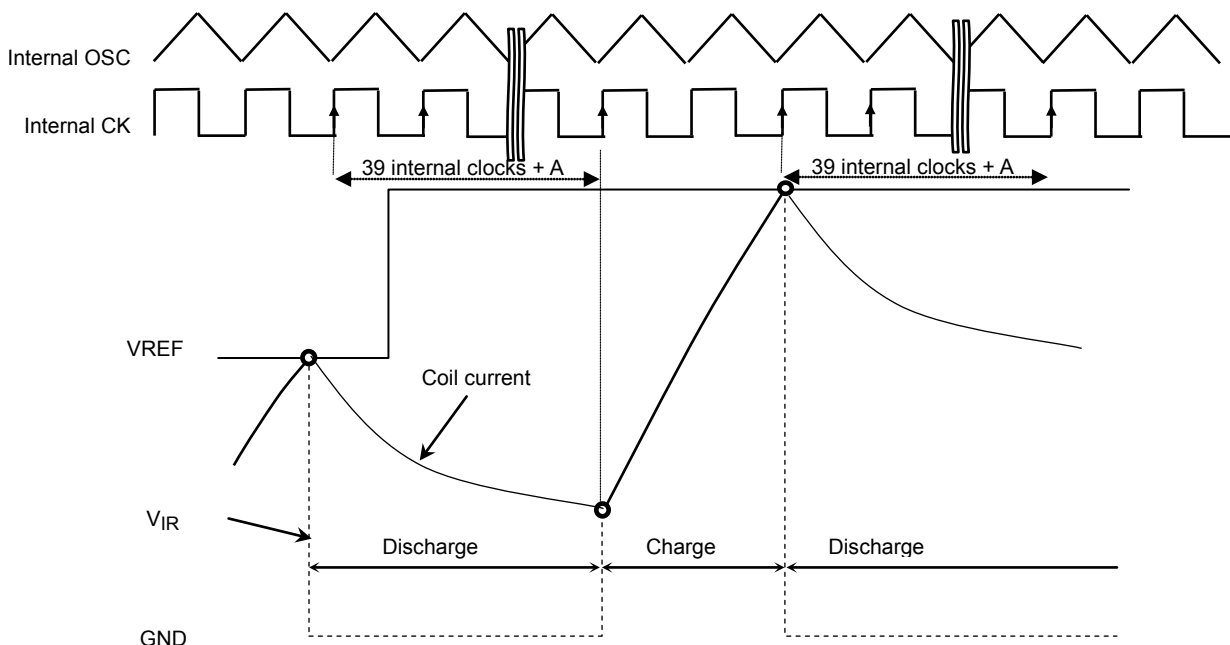

Due to the peak current detection technique, the average current value of the constant-current operation shall be smaller than the predetermined value. Because this depends on characteristics of used motor coils, precise identification of the used motor coils must be performed when determining the current value.

Notes on Contents

1. Block Diagrams

Some of the functional blocks, circuits, or constants in the block diagram may be omitted or simplified for explanatory purposes.

2. Equivalent Circuits

The equivalent circuit diagrams may be simplified or some parts of them may be omitted for explanatory purposes.

3. Timing Charts

Timing charts may be simplified for explanatory purposes.

4. Application Circuits

The application circuits shown in this document are provided for reference purposes only. Thorough evaluation is required, especially at the mass production design stage.

Toshiba does not grant any license to any industrial property rights by providing these examples of application circuits.

5. Test Circuits

Components in the test circuits are used only to obtain and confirm the device characteristics. These components and circuits are not guaranteed to prevent malfunction or failure from occurring in the application equipment.

IC Usage Considerations

Notes on handling of ICs

- [1] The absolute maximum ratings of a semiconductor device are a set of ratings that must not be exceeded, even for a moment. Do not exceed any of these ratings.
Exceeding the rating(s) may cause the device breakdown, damage or deterioration, and may result injury by explosion or combustion.
- [2] Use an appropriate power supply fuse to ensure that a large current does not continuously flow in case of over current and/or IC failure. The IC will fully break down when used under conditions that exceed its absolute maximum ratings, when the wiring is routed improperly or when an abnormal pulse noise occurs from the wiring or load, causing a large current to continuously flow and the breakdown can lead smoke or ignition. To minimize the effects of the flow of a large current in case of breakdown, appropriate settings, such as fuse capacity, fusing time and insertion circuit location, are required.
- [3] If your design includes an inductive load such as a motor coil, incorporate a protection circuit into the design to prevent device malfunction or breakdown caused by the current resulting from the inrush current at power ON or the negative current resulting from the back electromotive force at power OFF. IC breakdown may cause injury, smoke or ignition.
Use a stable power supply with ICs with built-in protection functions. If the power supply is unstable, the protection function may not operate, causing IC breakdown. IC breakdown may cause injury, smoke or ignition.
- [4] Do not insert devices in the wrong orientation or incorrectly.
Make sure that the positive and negative terminals of power supplies are connected properly.
Otherwise, the current or power consumption may exceed the absolute maximum rating, and exceeding the rating(s) may cause the device breakdown, damage or deterioration, and may result injury by explosion or combustion.
In addition, do not use any device that is applied the current with inserting in the wrong orientation or incorrectly even just one time.

Points to remember on handling of ICs**(1) Over current Protection Circuit**

Over current protection circuits (referred to as current limiter circuits) do not necessarily protect ICs under all circumstances. If the over current protection circuits operate against the over current, clear the over current status immediately.

Depending on the method of use and usage conditions, such as exceeding absolute maximum ratings can cause the over current protection circuit to not operate properly or IC breakdown before operation. In addition, depending on the method of use and usage conditions, if over current continues to flow for a long time after operation, the IC may generate heat resulting in breakdown.

(2) Thermal Shutdown Circuit

Thermal shutdown circuits do not necessarily protect ICs under all circumstances. If the thermal shutdown circuits operate against the over temperature, clear the heat generation status immediately.

Depending on the method of use and usage conditions, such as exceeding absolute maximum ratings can cause the thermal shutdown circuit to not operate properly or IC breakdown before operation.

(3) Heat Radiation Design

In using an IC with large current flow such as power amp, regulator or driver, please design the device so that heat is appropriately radiated, not to exceed the specified junction temperature (T_j) at any time and condition. These ICs generate heat even during normal use. An inadequate IC heat radiation design can lead to decrease in IC life, deterioration of IC characteristics or IC breakdown. In addition, please design the device taking into consideration the effect of IC heat radiation with peripheral components.

(4) Back-EMF

When a motor rotates in the reverse direction, stops or slows down abruptly, a current flow back to the motor's power supply due to the effect of back-EMF. If the current sink capability of the power supply is small, the device's motor power supply and output pins might be exposed to conditions beyond absolute maximum ratings. To avoid this problem, take the effect of back-EMF into consideration in system design.

RESTRICTIONS ON PRODUCT USE

- Toshiba Corporation, and its subsidiaries and affiliates (collectively "TOSHIBA"), reserve the right to make changes to the information in this document, and related hardware, software and systems (collectively "Product") without notice.
- This document and any information herein may not be reproduced without prior written permission from TOSHIBA. Even with TOSHIBA's written permission, reproduction is permissible only if reproduction is without alteration/omission.
- Though TOSHIBA works continually to improve Product's quality and reliability, Product can malfunction or fail. Customers are responsible for complying with safety standards and for providing adequate designs and safeguards for their hardware, software and systems which minimize risk and avoid situations in which a malfunction or failure of Product could cause loss of human life, bodily injury or damage to property, including data loss or corruption. Before customers use the Product, create designs including the Product, or incorporate the Product into their own applications, customers must also refer to and comply with (a) the latest versions of all relevant TOSHIBA information, including without limitation, this document, the specifications, the data sheets and application notes for Product and the precautions and conditions set forth in the "TOSHIBA Semiconductor Reliability Handbook" and (b) the instructions for the application with which the Product will be used with or for. Customers are solely responsible for all aspects of their own product design or applications, including but not limited to (a) determining the appropriateness of the use of this Product in such design or applications; (b) evaluating and determining the applicability of any information contained in this document, or in charts, diagrams, programs, algorithms, sample application circuits, or any other referenced documents; and (c) validating all operating parameters for such designs and applications. **TOSHIBA ASSUMES NO LIABILITY FOR CUSTOMERS' PRODUCT DESIGN OR APPLICATIONS.**
- **PRODUCT IS NEITHER INTENDED NOR WARRANTED FOR USE IN EQUIPMENTS OR SYSTEMS THAT REQUIRE EXTRAORDINARILY HIGH LEVELS OF QUALITY AND/OR RELIABILITY, AND/OR A MALFUNCTION OR FAILURE OF WHICH MAY CAUSE LOSS OF HUMAN LIFE, BODILY INJURY, SERIOUS PROPERTY DAMAGE AND/OR SERIOUS PUBLIC IMPACT ("UNINTENDED USE").** Except for specific applications as expressly stated in this document, Unintended Use includes, without limitation, equipment used in nuclear facilities, equipment used in the aerospace industry, medical equipment, equipment used for automobiles, trains, ships and other transportation, traffic signaling equipment, equipment used to control combustions or explosions, safety devices, elevators and escalators, devices related to electric power, and equipment used in finance-related fields. **IF YOU USE PRODUCT FOR UNINTENDED USE, TOSHIBA ASSUMES NO LIABILITY FOR PRODUCT.** For details, please contact your TOSHIBA sales representative.
- Do not disassemble, analyze, reverse-engineer, alter, modify, translate or copy Product, whether in whole or in part.
- Product shall not be used for or incorporated into any products or systems whose manufacture, use, or sale is prohibited under any applicable laws or regulations.
- The information contained herein is presented only as guidance for Product use. No responsibility is assumed by TOSHIBA for any infringement of patents or any other intellectual property rights of third parties that may result from the use of Product. No license to any intellectual property right is granted by this document, whether express or implied, by estoppel or otherwise.
- **ABSENT A WRITTEN SIGNED AGREEMENT, EXCEPT AS PROVIDED IN THE RELEVANT TERMS AND CONDITIONS OF SALE FOR PRODUCT, AND TO THE MAXIMUM EXTENT ALLOWABLE BY LAW, TOSHIBA (1) ASSUMES NO LIABILITY WHATSOEVER, INCLUDING WITHOUT LIMITATION, INDIRECT, CONSEQUENTIAL, SPECIAL, OR INCIDENTAL DAMAGES OR LOSS, INCLUDING WITHOUT LIMITATION, LOSS OF PROFITS, LOSS OF OPPORTUNITIES, BUSINESS INTERRUPTION AND LOSS OF DATA, AND (2) DISCLAIMS ANY AND ALL EXPRESS OR IMPLIED WARRANTIES AND CONDITIONS RELATED TO SALE, USE OF PRODUCT, OR INFORMATION, INCLUDING WARRANTIES OR CONDITIONS OF MERCHANTABILITY, FITNESS FOR A PARTICULAR PURPOSE, ACCURACY OF INFORMATION, OR NONINFRINGEMENT.**
- Do not use or otherwise make available Product or related software or technology for any military purposes, including without limitation, for the design, development, use, stockpiling or manufacturing of nuclear, chemical, or biological weapons or missile technology products (mass destruction weapons). Product and related software and technology may be controlled under the applicable export laws and regulations including, without limitation, the Japanese Foreign Exchange and Foreign Trade Law and the U.S. Export Administration Regulations. Export and re-export of Product or related software or technology are strictly prohibited except in compliance with all applicable export laws and regulations.
- Please contact your TOSHIBA sales representative for details as to environmental matters such as the RoHS compatibility of Product. Please use Product in compliance with all applicable laws and regulations that regulate the inclusion or use of controlled substances, including without limitation, the EU RoHS Directive. **TOSHIBA ASSUMES NO LIABILITY FOR DAMAGES OR LOSSES OCCURRING AS A RESULT OF NONCOMPLIANCE WITH APPLICABLE LAWS AND REGULATIONS.**