

Data Sheet | Item Number: 2716-258

PCB terminal block; lever; 16 mm²; Pin spacing 15 mm; 8-pole; CAGE CLAMP®; commoning option; gray

<https://www.wago.com/2716-258>



Color: ■ gray

Similar to illustration

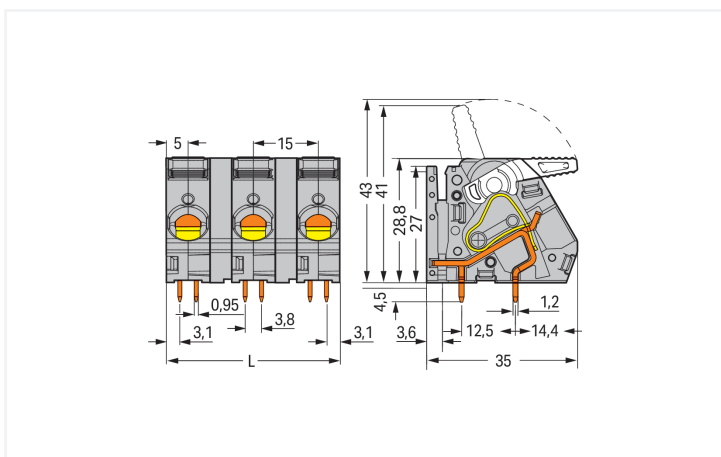
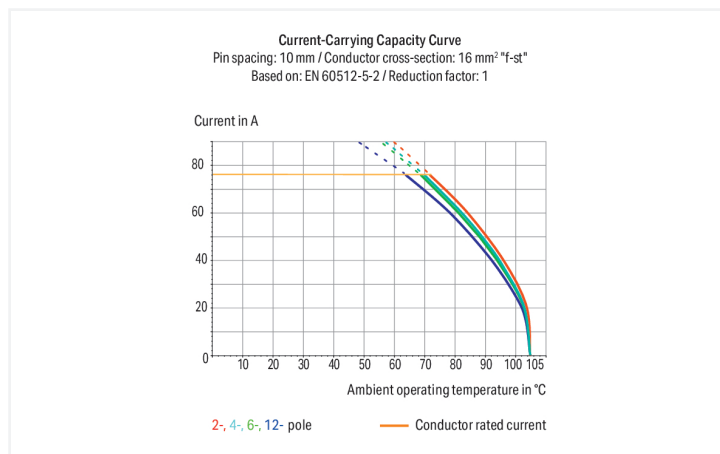

Dimensions in mm

L = (pole no. x pin spacing) – 5 mm

PCB terminal block, 2716 Series, CAGE CLAMP®

This PCB terminal block (item number 2716-258) is designed for simple and secure connections. It is a universal connector that can be used practically anywhere, for example, as a pluggable PCB connector, panel feedthrough header, connector for rail-mount terminal blocks, or a floating connector for different mounting methods. Strip lengths must be between 12 and 13 mm when connecting conductors to this PCB terminal block. This product features one conductor terminal and utilizes CAGE CLAMP®. Our CAGE CLAMP® connection provides a proven and maintenance-free way to connect all types of conductors. You do not need to prepare the conductor in any way, such as crimping ferrules. The dimensions are (115 x 33.3 x 35) mm (width x height x depth). This PCB terminal block is suitable for conductor cross sections ranging from 1.5 mm² to 16 mm².

Tin is used for coating the contact surfaces. A lever is used to operate this PCB terminal block. The PCB terminal block is designed for THT soldering. Insert the conductor into the board at a 30° angle.

Notes

Variants: 	Other pole numbers Other colors Mixed-color PCB connector strips Direct marking Other versions (or variants) can be requested from WAGO Sales or configured at https://configurator.wago.com/ .
-------------------	--

Electrical data

Ratings per	IEC/EN 60664-1			Approvals per	UL 1059		
Overvoltage category	III	III	II	Use group	B	C	D
Pollution degree	3	2	2	Rated voltage	600 V	600 V	-
Nominal voltage	800 V	1000 V	1000 V	Rated current	65 A	65 A	-
Rated impulse withstand voltage	8 kV	8 kV	8 kV				
Rated current	76 A	76 A	76 A				

Connection Data

Clamping units	8	Connection 1	
Total number of potentials	8	Connection technology	CAGE CLAMP®
Number of connection types	1	Actuation type	Lever
Number of levels	1	Solid conductor	1.5 ... 16 mm ² / 16 ... 6 AWG
Number of jumper slots	1	Fine-stranded conductor	1.5 ... 16 mm ² / 16 ... 6 AWG
		Fine-stranded conductor; with insulated ferrule	1.5 ... 10 mm ²
		Fine-stranded conductor; with uninsulated ferrule	1.5 ... 10 mm ²
		Strip length	12 ... 13 mm / 0.47 ... 0.51 inches
		Conductor connection direction to PCB	30 °
		Pole number	8

Physical data

Pin spacing	15 mm / 0.591 inches
Width	115 mm / 4.528 inches
Height	33.3 mm / 1.311 inches
Height from the surface	28.8 mm / 1.134 inches
Depth	35 mm / 1.378 inches
Solder pin length	4.5 mm
Solder pin dimensions	0.95 x 1.2 mm
!	1.6 ^(±0.1) mm

PCB contact

PCB contact	THT
Solder pin arrangement	over the entire terminal strip (in-line)
Number of solder pins per potential	4

Material data

Note (material data)	Information on material specifications can be found here
Color	gray
Material group	I
Insulation material (main housing)	Polyamide (PA66)
Flammability class per UL94	V0
Clamping spring material	Chrome-nickel spring steel (CrNi)
Contact material	Electrolytic copper (E _{Cu})
Contact Plating	Tin
Fire load	2.05 MJ
Weight	101.7 g

Environmental requirements

Limit temperature range	-60 ... +105 °C
-------------------------	-----------------

Commercial data

Product Group	4 (Printed Circuit Connectors)
PU (SPU)	8 pcs
Packaging type	Box
Country of origin	PL
GTIN	4045454739546
Customs tariff number	85369010000

Product Classification

UNSPSC	39121409
eCl@ss 10.0	27-44-04-01
eCl@ss 9.0	27-44-04-01
ETIM 9.0	EC002643
ETIM 10.0	EC002643
ECCN	NO US CLASSIFICATION

Environmental Product Compliance

RoHS Compliance Status	Compliant, No Exemption
------------------------	-------------------------

Approvals / Certificates

General approvals



Approval	Standard	Certificate Name
CCA DEKRA Certification B.V.	EN 60947	NTR NL-7131
cURus Underwriters Laboratories Inc.	UL 1059	E45172
KEMA/KEUR DEKRA Certification B.V.	EN 60947	71-117512

Downloads

Environmental Product Compliance

Compliance Search	
Environmental Product Compliance 2716-258	↓

Documentation

Additional Information			
Technical Section	03.04.2019	pdf 2027.26 KB	↓

CAD/CAE-Data

CAD data	
2D/3D Models 2716-258	↓

CAE data	
ZUKEN Portal 2716-258	↓

PCB Design

Symbol and Footprint via SamacSys 2716-258	↓
--	-------------------

Symbol and Footprint via Ultra Librarian 2716-258	↓
---	-------------------

1 Compatible Products

1.1 Optional Accessories

1.1.1 Ferrule

1.1.1.1 Ferrule

<p>Item No.: 216-264 Ferrule; Sleeve for 1.5 mm² / AWG 16; insulated; electro-tin plated; electrolytic copper; gastight crimped; acc. to DIN 46228, Part 4/09.90; black</p>	<p>Item No.: 216-284 Ferrule; Sleeve for 1.5 mm² / AWG 16; insulated; electro-tin plated; electrolytic copper; gastight crimped; acc. to DIN 46228, Part 4/09.90; black</p>	<p>Item No.: 216-289 Ferrule; Sleeve for 10 mm² / AWG 8; insulated; electro-tin plated; electrolytic copper; gastight crimped; acc. to DIN 46228, Part 4/09.90; red</p>	<p>Item No.: 216-209 Ferrule; Sleeve for 10 mm² / AWG 8; insulated; electro-tin plated; red</p>
<p>Item No.: 216-109 Ferrule; Sleeve for 10 mm² / AWG 8; un-insulated; electro-tin plated</p>	<p>Item No.: 216-266 Ferrule; Sleeve for 2.5 mm² / AWG 14; insulated; electro-tin plated; electrolytic copper; gastight crimped; acc. to DIN 46228, Part 4/09.90; blue</p>	<p>Item No.: 216-286 Ferrule; Sleeve for 2.5 mm² / AWG 14; insulated; electro-tin plated; electrolytic copper; gastight crimped; acc. to DIN 46228, Part 4/09.90; blue</p>	<p>Item No.: 216-267 Ferrule; Sleeve for 4 mm² / AWG 12; insulated; electro-tin plated; electrolytic copper; gastight crimped; acc. to DIN 46228, Part 4/09.90; gray</p>
<p>Item No.: 216-287 Ferrule; Sleeve for 4 mm² / AWG 12; insulated; electro-tin plated; electrolytic copper; gastight crimped; acc. to DIN 46228, Part 4/09.90; gray</p>	<p>Item No.: 216-208 Ferrule; Sleeve for 6 mm² / AWG 10; insulated; electro-tin plated; electrolytic copper; gastight crimped; acc. to DIN 46228, Part 4/09.90; yellow</p>	<p>Item No.: 216-288 Ferrule; Sleeve for 6 mm² / AWG 10; insulated; electro-tin plated; electrolytic copper; gastight crimped; acc. to DIN 46228, Part 4/09.90; yellow</p>	<p>Item No.: 216-108 Ferrule; Sleeve for 6 mm² / AWG 10; un-insulated; electro-tin plated; silver-colored</p>

1.1.2 Jumper

1.1.2.1 Jumper



Item No.: 745-632

Jumper; 2-way; silver-colored

Item No.: 745-631

Jumper; 2-way; unplated; silver-colored

Item No.: 745-633

Jumper; 3-way; unplated; silver-colored

Item No.: 745-634

Jumper; 4-way; silver-colored



Item No.: 745-635

Jumper; 5-way; unplated; silver-colored

1.1.3 Test and measurement

1.1.3.1 Testing accessories



Item No.: 210-136

Test plug; 2 mm Ø; with 500 mm cable; red

Installation Notes

Conductor termination

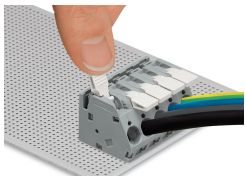

To open the clamping unit, pull the operating lever all the way back — 2706 and 2716 Series.

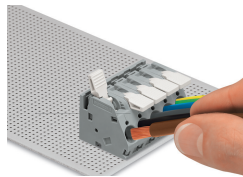

Inserting/removing a conductor – 2706 and 2716 Series.

Testing

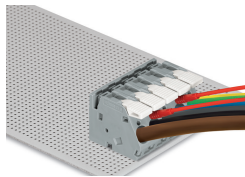

Testing with test plug – 2706 and 2716 Series.

Commoning

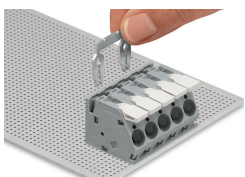

Inserting a comb-style jumper bar.

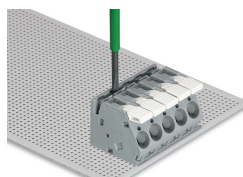

Push jumper bar down firmly using a screwdriver until it hits the backstop – 2706 and 2716 Series.

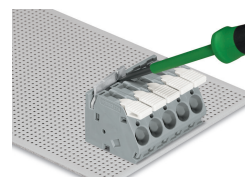

To remove the comb-style jumper bar, lift it up using a screwdriver – 2706 and 2716 Series.

Subject to changes. Please also observe the further product documentation!

Current addresses can be found at: www.wago.com