



## 3.0-A ULTRA-LDO WITH PROGRAMMABLE SOFT-START

 Check for Samples: [TPS74401-EP](#)

### FEATURES

- Soft-Start (SS) Pin Provides a Linear Startup with Ramp Time Set by External Capacitor
- 1% Accuracy Over Line, Load, and Temperature
- Supports Input Voltages as Low as 0.9 V with External Bias Supply
- Adjustable Output (0.8 V to 3.6 V)
- Ultra-Low Dropout: 115 mV at 3.0 A (typ)
- Stable with Any or No Output Capacitor
- Excellent Transient Response
- Available in 5 mm × 5 mm × 1 mm QFN Package
- Active High Enable

### SUPPORTS DEFENSE, AEROSPACE, AND MEDICAL APPLICATIONS

- Controlled Baseline
- One Assembly/Test Site
- One Fabrication Site
- Available in Military (–55°C/125°C) Temperature Ranges<sup>(1)</sup>
- Extended Product Life Cycle
- Extended Product-Change Notification
- Product Traceability

(1) Custom temperature ranges available

### APPLICATIONS

- FPGA Applications
- DSP Core and I/O Voltages
- Post-Regulation Applications
- Applications with Special Start-Up Time or Sequencing Requirements
- Hot-Swap and Inrush Controls

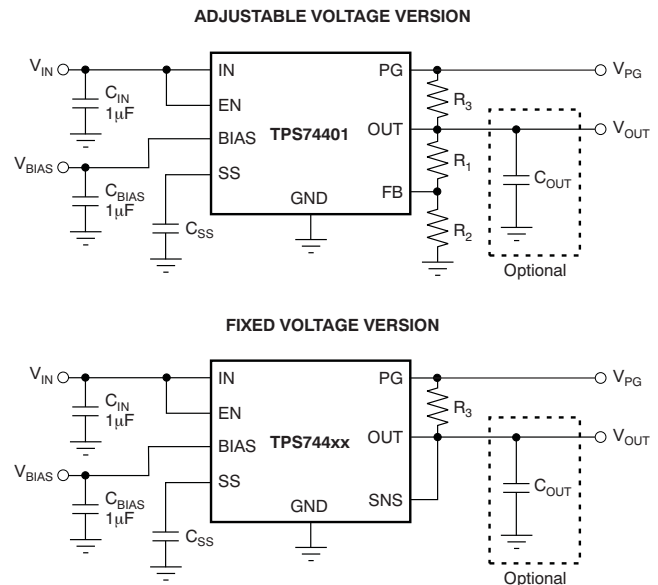

**Figure 1. Typical Application Circuit**



Please be aware that an important notice concerning availability, standard warranty, and use in critical applications of Texas Instruments semiconductor products and disclaimers thereto appears at the end of this data sheet.

All trademarks are the property of their respective owners.

PRODUCTION DATA information is current as of publication date. Products conform to specifications per the terms of the Texas Instruments standard warranty. Production processing does not necessarily include testing of all parameters.

Copyright © 2010, Texas Instruments Incorporated



This integrated circuit can be damaged by ESD. Texas Instruments recommends that all integrated circuits be handled with appropriate precautions. Failure to observe proper handling and installation procedures can cause damage.

ESD damage can range from subtle performance degradation to complete device failure. Precision integrated circuits may be more susceptible to damage because very small parametric changes could cause the device not to meet its published specifications.

## DESCRIPTION

The TPS74401 low-dropout (LDO) linear regulator provides an easy-to-use robust power management solution for a wide variety of applications. User-programmable soft-start minimizes stress on the input power source by reducing capacitive inrush current on start-up. The soft-start is monotonic and well-suited for powering many different types of processors and ASICs. The enable input and power-good output allow easy sequencing with external regulators. This complete flexibility permits the user to configure a solution that will meet the sequencing requirements of FPGAs, DSPs, and other applications with specific start-up requirements.

A precision reference and error amplifier deliver 1% accuracy over load, line, temperature, and process. Each LDO is stable with low-cost ceramic output capacitors and the device is fully specified from  $-55^{\circ}\text{C}$  to  $125^{\circ}\text{C}$ .

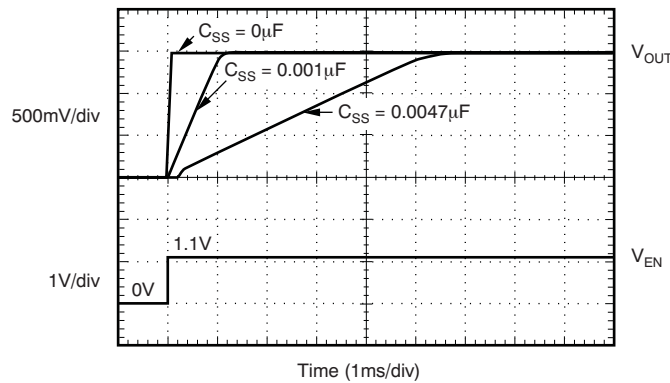

Figure 2. Turn-On Response

Table 1. ORDERING INFORMATION<sup>(1)</sup>

$T_A$	PACKAGE <sup>(2)</sup>		ORDERABLE PART NUMBER	TOP-SIDE MARKING
$-55^{\circ}\text{C}$ to $125^{\circ}\text{C}$	QFN (RGW)	Reel of 3000	TPS74401MRGWREP	TPS74401EP

(1) For the most current package and ordering information, see the Package Option Addendum at the end of this document, or see the TI Web site at [www.ti.com](http://www.ti.com).

(2) Package drawings, standard packing quantities, thermal data, symbolization, and PCB design guidelines are available at [www.ti.com/sc/package](http://www.ti.com/sc/package).

## ABSOLUTE MAXIMUM RATINGS<sup>(1)</sup>

At  $T_J = -55^\circ\text{C}$  to  $+125^\circ\text{C}$ , unless otherwise noted. All voltages are with respect to GND.

			UNIT
$V_{IN}, V_{BIAS}$	Input voltage range	-0.3 to +6	V
$V_{EN}$	Enable voltage range	-0.3 to +6	V
$V_{PG}$	Power-good voltage range	-0.3 to +6	V
$I_{PG}$	PG sink current	0 to +1.5	mA
$V_{SS}$	SS pin voltage range	-0.3 to +6	V
$V_{FB}$	Feedback pin voltage range	-0.3 to +6	V
$V_{OUT}$	Output voltage range	-0.3 to $V_{IN} + 0.3$	V
$I_{OUT}$	Maximum output current	Internally limited	
	Output short circuit duration	Indefinite	
$T_J$	Operating junction temperature range	-55 to +125	$^\circ\text{C}$
$T_{STG}$	Storage junction temperature range	-65 to +150	$^\circ\text{C}$

- (1) Stresses beyond those listed under *Absolute Maximum Ratings* may cause permanent damage to the device. These are stress ratings only and functional operation of the device at these conditions is not implied. Exposure to absolute-maximum-rated conditions for extended periods may affect device reliability.

## THERMAL INFORMATION

THERMAL METRIC <sup>(1)(2)</sup>		TPS74401-EP	UNITS
		RGW (20 PINS)	
$\theta_{JA}$	Junction-to-ambient thermal resistance	36.3	$^\circ\text{C}/\text{W}$
$\theta_{Jc\text{top}}$	Junction-to-case (top) thermal resistance	34.3	
$\theta_{JB}$	Junction-to-board thermal resistance	10.8	
$\psi_{JT}$	Junction-to-top characterization parameter	0.3	
$\psi_{JB}$	Junction-to-board characterization parameter	11.9	
$\theta_{Jc\text{bot}}$	Junction-to-case (bottom) thermal resistance	2.4	

- (1) For more information about traditional and new thermal metrics, see the *IC Package Thermal Metrics* application report, [SPRA953](#).  
 (2) For thermal estimates of this device based on PCB copper area, see the [TI PCB Thermal Calculator](#).

## ELECTRICAL CHARACTERISTICS

At  $V_{EN} = 1.1\text{ V}$ ,  $V_{IN} = V_{OUT} + 0.3\text{ V}$ ,  $C_{IN} = C_{BIAS} = 0.1\text{ }\mu\text{F}$ ,  $C_{OUT} = 10\text{ }\mu\text{F}$ ,  $I_{OUT} = 50\text{ mA}$ ,  $V_{BIAS} = 5.0\text{ V}$ , and  $T_J = -55^\circ\text{C}$  to  $+125^\circ\text{C}$ , unless otherwise noted. Typical values are at  $T_J = +25^\circ\text{C}$ .

PARAMETER		TEST CONDITIONS	MIN	TYP	MAX	UNIT	
$V_{IN}$	Input voltage range		$V_{OUT} + V_{DO}$		5.5	V	
$V_{BIAS}$	Bias pin voltage range		2.375		5.25	V	
$V_{REF}$	Internal reference (Adj.)		0.792		0.808	V	
$V_{OUT}$	Output voltage range	$V_{IN} = 5\text{ V}$ , $I_{OUT} = 1.5\text{ A}$ , $V_{BIAS} = 5\text{ V}$	$V_{REF}$		3.6	V	
	Accuracy <sup>(1)</sup>	$2.97\text{ V} \leq V_{BIAS} \leq 5.25\text{ V}$ , $50\text{ mA} \leq I_{OUT} \leq 3.0\text{ A}$	-1	$\pm 0.2$	+1	%	
$V_{OUT}/V_{IN}$	Line regulation	$V_{OUT(NOM)} + 0.3 \leq V_{IN} \leq 5.5\text{ V}$		0.0005	0.05	%/V	
$V_{OUT}/I_{OUT}$	Load regulation	$0\text{ mA} \leq I_{OUT} \leq 50\text{ mA}$		0.013		%/mA	
		$50\text{ mA} \leq I_{OUT} \leq 3.0\text{ A}$		0.03		%/A	
$V_{DO}$	$V_{IN}$ dropout voltage <sup>(2)</sup>	$I_{OUT} = 3.0\text{ A}$ , $V_{BIAS} - V_{OUT(NOM)} \geq 1.62\text{ V}$		120	195	mV	
	$V_{BIAS}$ dropout voltage <sup>(2)</sup>	$I_{OUT} = 3.0\text{ A}$ , $V_{IN} = V_{BIAS}$			1.62	V	
$I_{CL}$	Current limit	$V_{OUT} = 80\% \times V_{OUT(NOM)}$	3.7		6.0	A	
$I_{BIAS}$	Bias pin current	$I_{OUT} = 0\text{ mA}$ to $3.0\text{ A}$		2	4	mA	
$I_{SHDN}$	Shutdown supply current ( $V_{IN}$ )	$V_{EN} \leq 0.4\text{ V}$		0.4	1	$\mu\text{A}$	
$I_{FB}$	Feedback pin current <sup>(3)</sup>	$I_{OUT} = 50\text{ mA}$ to $3.0\text{ A}$	-250	95	250	nA	
PSRR <sup>(4)</sup>	Power-supply rejection ( $V_{IN}$ to $V_{OUT}$ )	1 kHz, $I_{OUT} = 1.5\text{ A}$ , $V_{IN} = 1.8\text{ V}$ , $V_{OUT} = 1.5\text{ V}$		73		dB	
		800 kHz, $I_{OUT} = 1.5\text{ A}$ , $V_{IN} = 1.8\text{ V}$ , $V_{OUT} = 1.5\text{ V}$		42			
	Power-supply rejection ( $V_{BIAS}$ to $V_{OUT}$ )	1 kHz, $I_{OUT} = 1.5\text{ A}$ , $V_{IN} = 1.8\text{ V}$ , $V_{OUT} = 1.5\text{ V}$			62		dB
		800 kHz, $I_{OUT} = 1.5\text{ A}$ , $V_{IN} = 1.8\text{ V}$ , $V_{OUT} = 1.5\text{ V}$			50		
Noise	Output noise voltage	100 Hz to 100 kHz, $I_{OUT} = 1.5\text{ A}$ , $C_{SS} = 0.001\text{ }\mu\text{F}$		$16 \times V_{OUT}$		$\mu\text{V}_{RMS}$	
$V_{TRAN}$	% $V_{OUT}$ droop during load transient	$I_{OUT} = 100\text{ mA}$ to $3.0\text{ A}$ at $1\text{ A}/\mu\text{s}$ , $C_{OUT} = 0\text{ }\mu\text{F}$		4		% $V_{OUT}$	
$t_{STR}$	Minimum startup time	$I_{OUT} = 1.5\text{ A}$ , $C_{SS} = \text{open}$		100		$\mu\text{s}$	
$I_{SS}$	Soft-start charging current	$V_{SS} = 0.4\text{ V}$	0.5	0.73	1	$\mu\text{A}$	
$V_{EN, HI}$	Enable input high level		1.1		5.5	V	
$V_{EN, LO}$	Enable input low level		0		0.4	V	
$V_{EN, HYS}$	Enable pin hysteresis			50		mV	
$V_{EN, DG}$	Enable pin deglitch time			20		$\mu\text{s}$	
$I_{EN}$	Enable pin current	$V_{EN} = 5\text{ V}$		0.1	1	$\mu\text{A}$	
$V_{IT}$	PG trip threshold	$V_{OUT}$ decreasing	86	90	93.5	% $V_{OUT}$	
$V_{HYS}$	PG trip hysteresis			3		% $V_{OUT}$	
$V_{PG, LO}$	PG output low voltage	$I_{PG} = 1\text{ mA}$ (sinking), $V_{OUT} < V_{IT}$			0.3	V	
$I_{PG, LKG}$	PG leakage current	$V_{PG} = 5.25\text{ V}$ , $V_{OUT} > V_{IT}$		0.03	1	$\mu\text{A}$	
$T_J$	Operating junction temperature		-55		+125	$^\circ\text{C}$	
$T_{SD}$	Thermal shutdown temperature	Shutdown, temperature increasing		+155		$^\circ\text{C}$	
		Reset, temperature decreasing		+140			

- (1) Adjustable devices tested at 0.8 V; external resistor tolerance is not taken into account.
- (2) Dropout is defined as the voltage from the input to  $V_{OUT}$  when  $V_{OUT}$  is 2% below nominal.
- (3)  $I_{FB}$  current flow is out of the device.
- (4) See Figure 10 to Figure 13 for PSRR at different conditions.

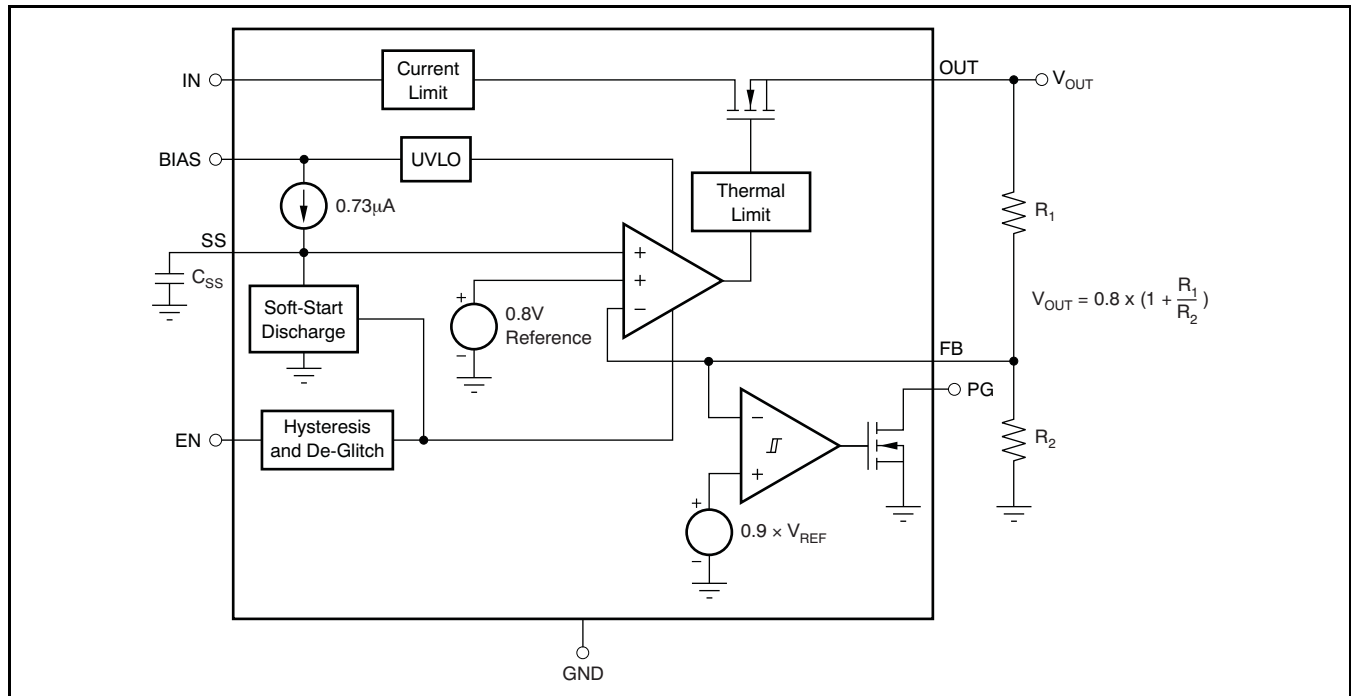
**BLOCK DIAGRAM**

**Table 2. Standard 1% Resistor Values for Programming the Output Voltage<sup>(1)</sup>**

R <sub>1</sub> (kΩ)	R <sub>2</sub> (kΩ)	V <sub>OUT</sub> (V)
Short	Open	0.8
0.619	4.99	0.9
1.13	4.53	1.0
1.37	4.42	1.05
1.87	4.99	1.1
2.49	4.99	1.2
4.12	4.75	1.5
3.57	2.87	1.8
3.57	1.69	2.5
3.57	1.15	3.3

<sup>(1)</sup>  $V_{OUT} = 0.8 \times (1 + R_1/R_2)$ 
**Table 3. Standard Capacitor Values for Programming the Soft-Start Time<sup>(1)</sup>**

C <sub>SS</sub>	SOFT-START TIME
Open	0.1 ms
470 pF	0.5 ms
1000 pF	1 ms
4700 pF	5 ms
0.01 µF	10 ms
0.015 µF	16 ms

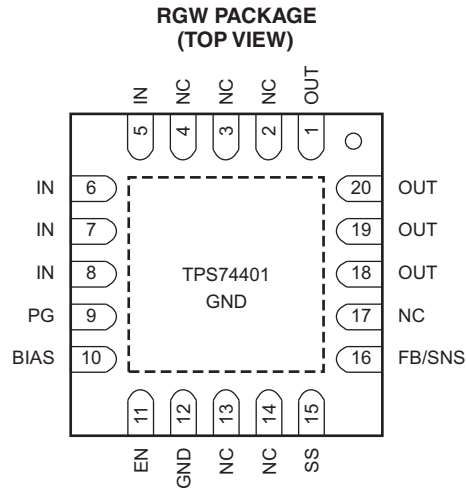
<sup>(1)</sup>  $t_{SS}(s) = 0.8 \times C_{SS}(F)/7.3 \times 10^{-7}$



**PIN DESCRIPTIONS**

NAME	NO.	DESCRIPTION
IN	5–8	Unregulated input to the device.
EN	11	Enable pin. Driving this pin high enables the regulator. Driving this pin low puts the regulator into shutdown mode. This pin must not be left floating.
SS	15	Soft-Start pin. A capacitor connected on this pin to ground sets the start-up time. If this pin is left floating, the regulator output soft-start ramp time is typically 100µs.
BIAS	10	Bias input voltage for error amplifier, reference, and internal control circuits.
PG	9	Power-Good (PG) is an open-drain, active-high output that indicates the status of $V_{OUT}$ . When $V_{OUT}$ exceeds the PG trip threshold, the PG pin goes into a high-impedance state. When $V_{OUT}$ is below this threshold the pin is driven to a low-impedance state. A pull-up resistor from 10kΩ to 1MΩ should be connected from this pin to a supply up to 5.5V. The supply can be higher than the input voltage. Alternatively, the PG pin can be left floating if output monitoring is not necessary.
FB	16	This pin is the feedback connection to the center tap of an external resistor divider network that sets the output voltage. This pin must not be left floating.
OUT	1, 18–20	Regulated output voltage. No capacitor is required on this pin for stability.
NC	2–4, 13, 14, 17	No connection. This pin can be left floating or connected to GND to allow better thermal contact to the top-side plane.
GND	12	Ground
PAD/TAB		Should be soldered to the ground plane for increased thermal performance.

### TYPICAL CHARACTERISTICS

At  $T_J = +25^\circ\text{C}$ ,  $V_{OUT} = 1.5\text{ V}$ ,  $V_{IN} = V_{OUT(TYP)} + 0.3\text{ V}$ ,  $V_{BIAS} = 3.3\text{ V}$ ,  $I_{OUT} = 50\text{ mA}$ ,  $C_{IN} = 1\ \mu\text{F}$ ,  $C_{BIAS} = 1\ \mu\text{F}$ ,  $C_{SS} = 0.01\ \mu\text{F}$ , and  $C_{OUT} = 10\ \mu\text{F}$ , unless otherwise noted.

**LOAD REGULATION**

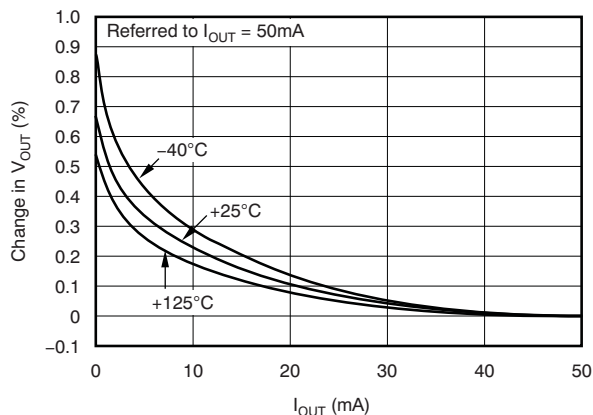

**Figure 3.**

**LOAD REGULATION**

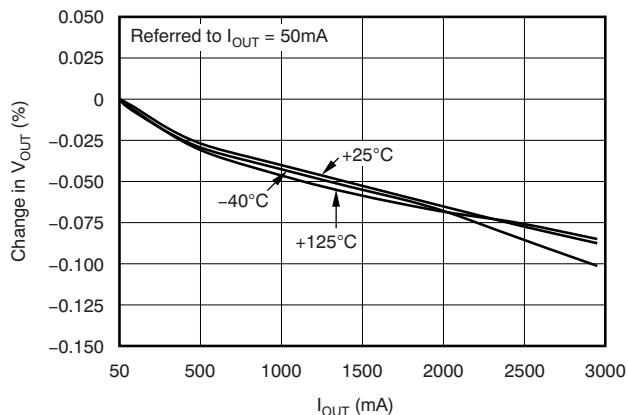

**Figure 4.**

**LINE REGULATION**

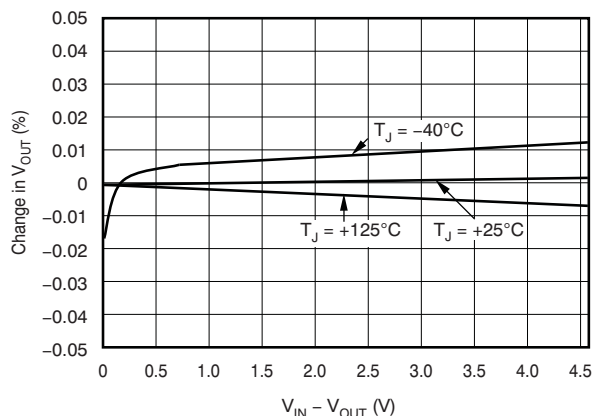

**Figure 5.**

**V<sub>IN</sub> DROPOUT VOLTAGE vs I<sub>OUT</sub> AND TEMPERATURE (T<sub>J</sub>)**

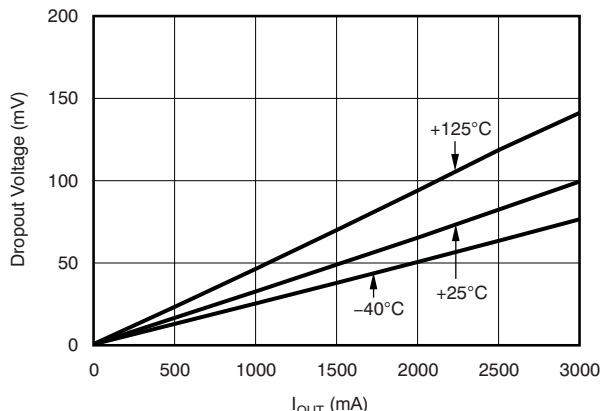

**Figure 6.**

**V<sub>IN</sub> DROPOUT VOLTAGE vs V<sub>BIAS</sub> - V<sub>OUT</sub> AND TEMPERATURE (T<sub>J</sub>)**

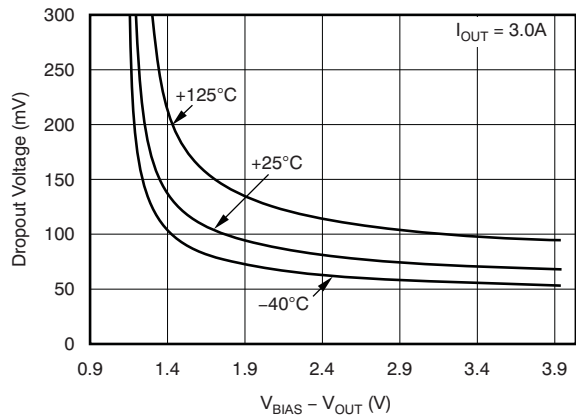

**Figure 7.**

**V<sub>IN</sub> DROPOUT VOLTAGE vs V<sub>BIAS</sub> - V<sub>OUT</sub> AND TEMPERATURE (T<sub>J</sub>)**

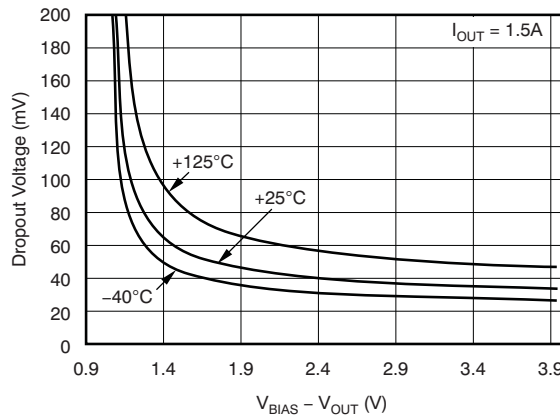

**Figure 8.**

**TYPICAL CHARACTERISTICS (continued)**

At  $T_J = +25^\circ\text{C}$ ,  $V_{OUT} = 1.5\text{ V}$ ,  $V_{IN} = V_{OUT(TYP)} + 0.3\text{ V}$ ,  $V_{BIAS} = 3.3\text{ V}$ ,  $I_{OUT} = 50\text{ mA}$ ,  $C_{IN} = 1\ \mu\text{F}$ ,  $C_{BIAS} = 1\ \mu\text{F}$ ,  $C_{SS} = 0.01\ \mu\text{F}$ , and  $C_{OUT} = 10\ \mu\text{F}$ , unless otherwise noted.

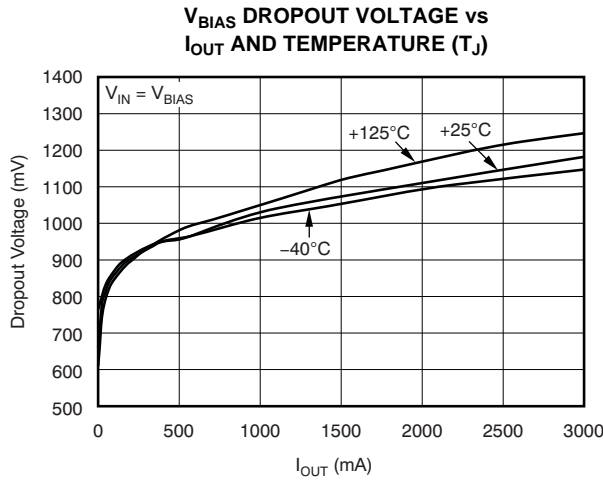

Figure 9.

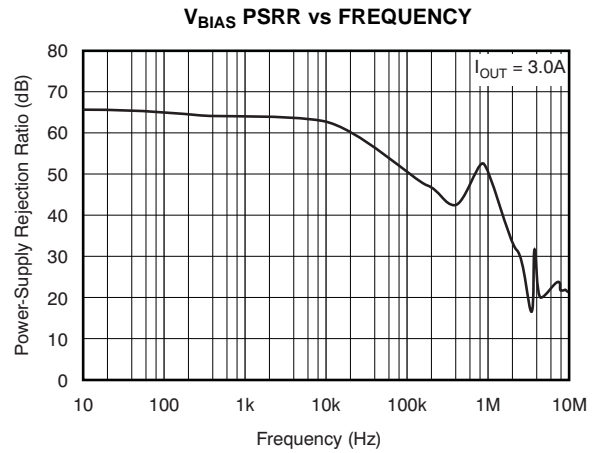

Figure 10.

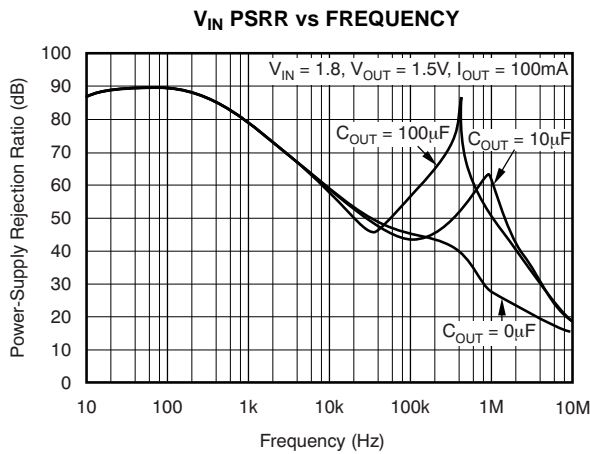

Figure 11.

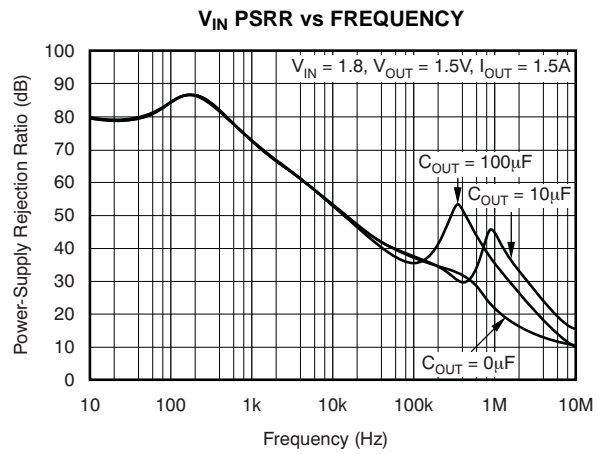

Figure 12.

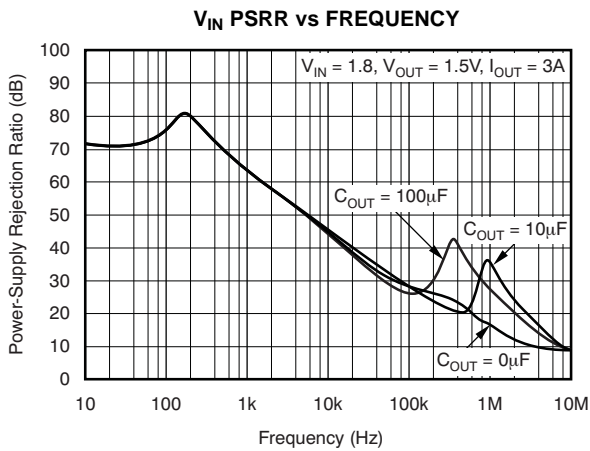

Figure 13.

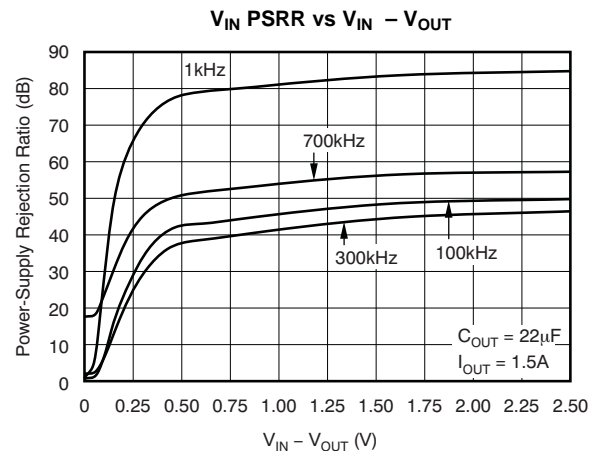

Figure 14.



**TYPICAL CHARACTERISTICS (continued)**

At  $T_J = +25^\circ\text{C}$ ,  $V_{OUT} = 1.5\text{ V}$ ,  $V_{IN} = V_{OUT(TYP)} + 0.3\text{ V}$ ,  $V_{BIAS} = 3.3\text{ V}$ ,  $I_{OUT} = 50\text{ mA}$ ,  $C_{IN} = 1\ \mu\text{F}$ ,  $C_{BIAS} = 1\ \mu\text{F}$ ,  $C_{SS} = 0.01\ \mu\text{F}$ , and  $C_{OUT} = 10\ \mu\text{F}$ , unless otherwise noted.

**NOISE SPECTRAL DENSITY**

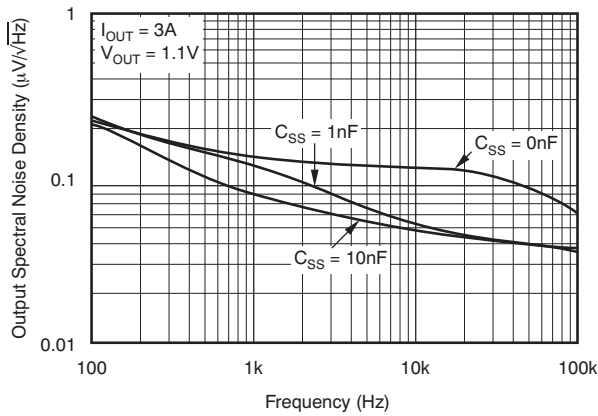

**Figure 15.**

**NOISE SPECTRAL DENSITY**

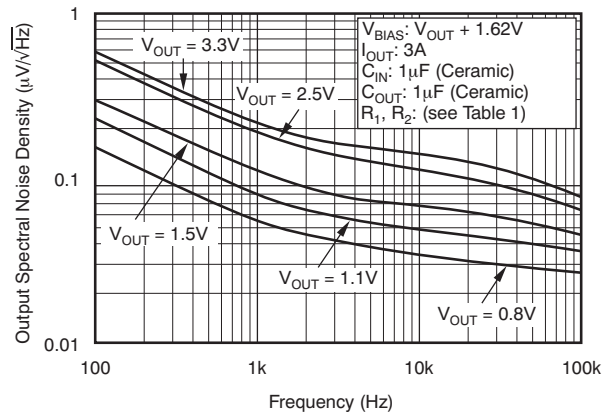

**Figure 16.**

**I<sub>BIAS</sub> vs I<sub>OUT</sub> AND TEMPERATURE**

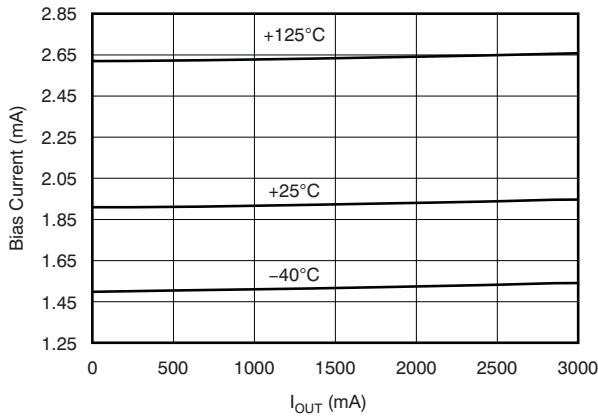

**Figure 17.**

**I<sub>BIAS</sub> vs V<sub>BIAS</sub> AND V<sub>OUT</sub>**

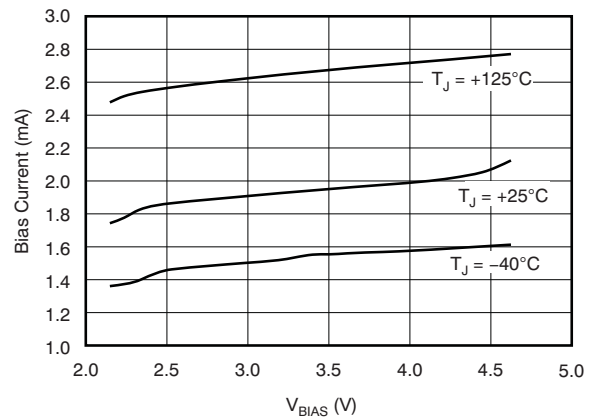

**Figure 18.**

**I<sub>BIAS</sub> SHUTDOWN vs TEMPERATURE**

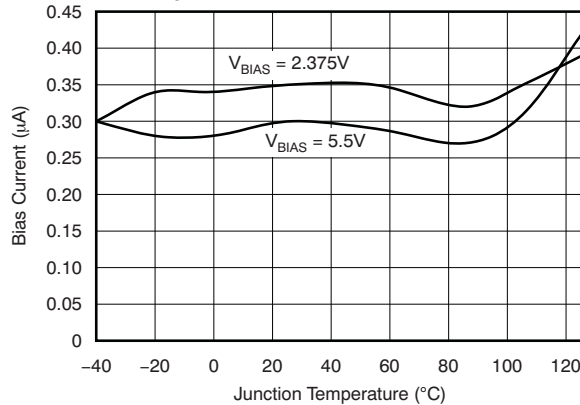

**Figure 19.**

**TYPICAL CHARACTERISTICS (continued)**

At  $T_J = +25^\circ\text{C}$ ,  $V_{OUT} = 1.5\text{ V}$ ,  $V_{IN} = V_{OUT(TYP)} + 0.3\text{ V}$ ,  $V_{BIAS} = 3.3\text{ V}$ ,  $I_{OUT} = 50\text{ mA}$ ,  $C_{IN} = 1\ \mu\text{F}$ ,  $C_{BIAS} = 1\ \mu\text{F}$ ,  $C_{SS} = 0.01\ \mu\text{F}$ , and  $C_{OUT} = 10\ \mu\text{F}$ , unless otherwise noted.

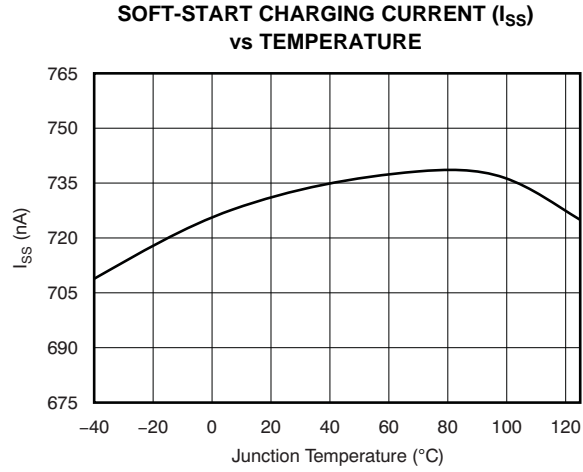

Figure 20.

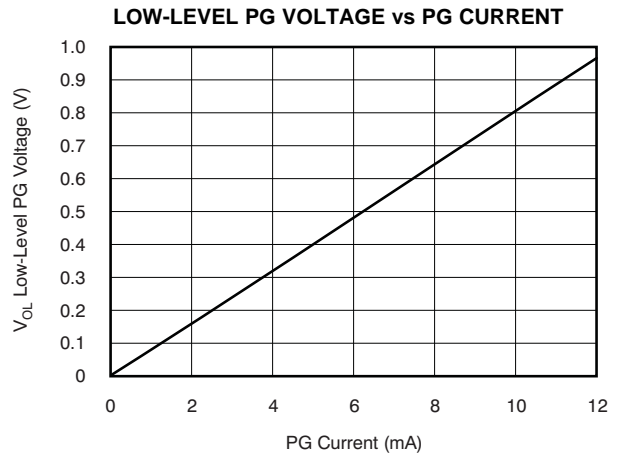
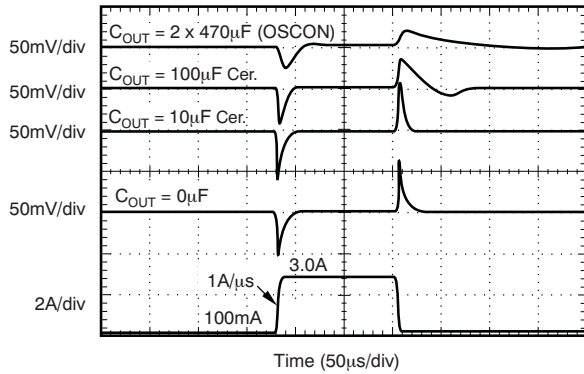

Figure 21.

**TYPICAL CHARACTERISTICS (continued)**

At  $T_J = +25^\circ\text{C}$ ,  $V_{OUT} = 1.5\text{ V}$ ,  $V_{IN} = V_{OUT(TYP)} + 0.3\text{ V}$ ,  $V_{BIAS} = 3.3\text{ V}$ ,  $I_{OUT} = 50\text{ mA}$ ,  $C_{IN} = 1\ \mu\text{F}$ ,  $C_{BIAS} = 1\ \mu\text{F}$ ,  $C_{SS} = 0.01\ \mu\text{F}$ , and  $C_{OUT} = 10\ \mu\text{F}$ , unless otherwise noted.

**LOAD TRANSIENT RESPONSE**



**Figure 22.**

**V<sub>BIAS</sub> LINE TRANSIENT (3A)**

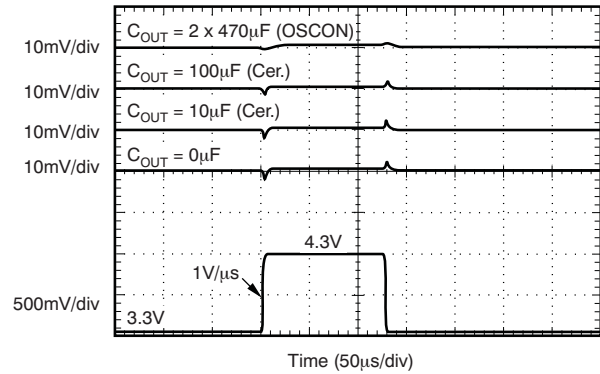

**Figure 23.**

**V<sub>IN</sub> LINE TRANSIENT (3A)**

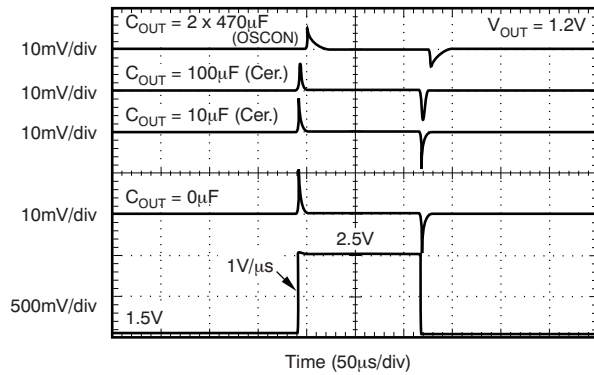

**Figure 24.**

**TURN-ON RESPONSE**

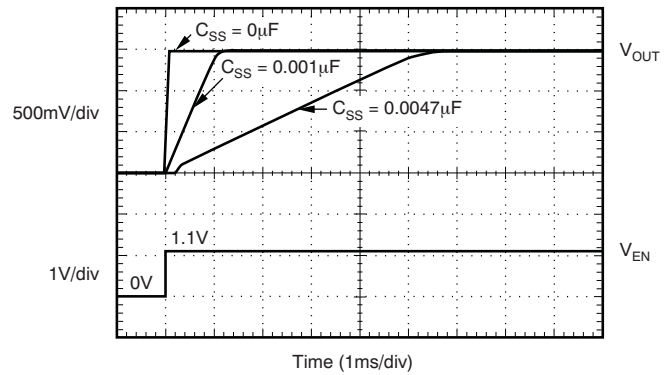

**Figure 25.**

**POWER-UP/POWER-DOWN**

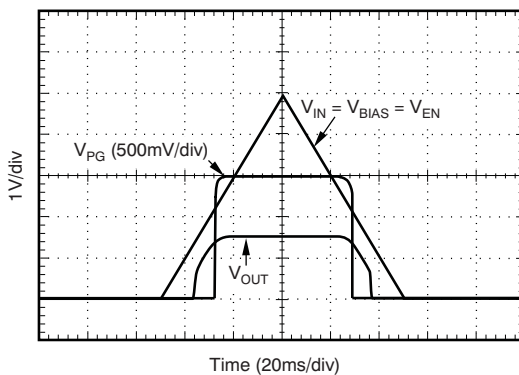

**Figure 26.**

**OUTPUT SHORT-CIRCUIT RECOVERY**

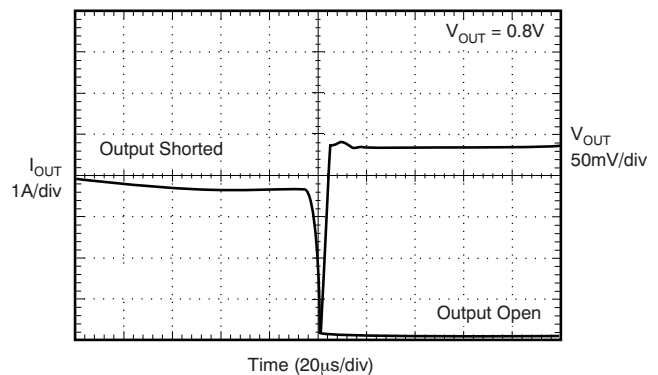

**Figure 27.**

## APPLICATION INFORMATION

The TPS74401 belongs to a family of new generation ultra-low dropout regulators that feature soft-start and tracking capabilities. These regulators use a low current bias input to power all internal control circuitry, allowing the NMOS pass transistor to regulate very low input and output voltages.

The use of an NMOS-pass FET offers several critical advantages for many applications. Unlike a PMOS topology device, the output capacitor has little effect on loop stability. This architecture allows the TPS74401 to be stable with any or even no output capacitor. Transient response is also superior to PMOS topologies, particularly for low  $V_{IN}$  applications.

The TPS74401 features a programmable, voltage-controlled soft-start circuit that provides a smooth, monotonic start-up and limits startup inrush currents that may be caused by large capacitive loads. A power-good (PG) output is available to allow supply monitoring and sequencing of other supplies. An enable (EN) pin with hysteresis and deglitch allows slow-ramping signals to be used for sequencing the device. The low  $V_{IN}$  and  $V_{OUT}$  capability allows for inexpensive, easy-to-design, and efficient linear regulation between the multiple supply voltages often present in processor intensive systems.

**Figure 28** illustrates a typical application circuit for the TPS74401 adjustable output device.

$R_1$  and  $R_2$  can be calculated for any output voltage using the formula shown in **Figure 28**. Refer to **Table 2** for sample resistor values of common output voltages. In order to achieve the maximum accuracy specifications,  $R_2$  should be  $\leq 4.99 \text{ k}\Omega$ .

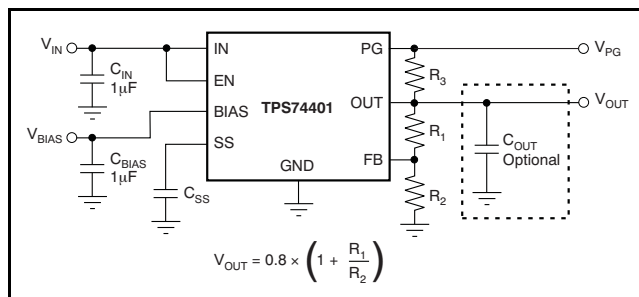

**Figure 28. Typical Application Circuit for the TPS74401 (Adjustable)**

### INPUT, OUTPUT, AND BIAS CAPACITOR REQUIREMENTS

The device does not require any output capacitor for stability. If an output capacitor is needed, the device is designed to be stable for all available types and values of output capacitance. The device is also stable with multiple capacitors in parallel, of any type or value.

The capacitance required on the IN and BIAS pins strongly depends on the input supply source impedance. To counteract any inductance in the input, the minimum recommended capacitor for  $V_{IN}$  and  $V_{BIAS}$  is  $1 \mu\text{F}$ . If  $V_{IN}$  and  $V_{BIAS}$  are connected to the same supply, the recommended minimum capacitor for  $V_{BIAS}$  is  $4.7 \mu\text{F}$ . Good quality, low ESR capacitors should be used on the input; ceramic X5R and X7R capacitors are preferred. These capacitors should be placed as close the pins as possible for optimum performance.

### TRANSIENT RESPONSE

The TPS74401 was designed to have transient response within 5% for most applications without any output capacitor. In some cases, the transient response may be limited by the transient response of the input supply. This limitation is especially true in applications where the difference between the input and output is less than 300 mV. In this case, adding additional input capacitance improves the transient response much more than just adding additional output capacitance. With a solid input supply, adding additional output capacitance reduces undershoot and overshoot during a transient at the expense of a slightly longer  $V_{OUT}$  recovery time. Refer to **Figure 22** in the Typical Characteristics section. Since the TPS74401 is stable without an output capacitor, many applications may allow for little or no capacitance at the LDO output. For these applications, local bypass capacitance for the device under power may be sufficient to meet the transient requirements of the application. This design reduces the total solution cost by avoiding the need to use expensive high-value capacitors at the LDO output.

## DROPOUT VOLTAGE

The TPS74401 offers industry-leading dropout performance, making it well-suited for high-current low  $V_{IN}$ /low  $V_{OUT}$  applications. The extremely low dropout of the TPS74401 allows the device to be used in place of a DC/DC converter and still achieve good efficiencies. This efficiency allows users to rethink the power architecture for their applications to achieve the smallest, simplest, and lowest cost solution.

There are two different specifications for dropout voltage with the TPS74401. The first specification (see Figure 29) is referred to as  $V_{IN}$  Dropout and is for users that wish to apply an external bias voltage to achieve low dropout. This specification assumes that  $V_{BIAS}$  is at least 1.62 V above  $V_{OUT}$ , which is the case for  $V_{BIAS}$  when powered by a 3.3-V rail with 5% tolerance and with  $V_{OUT} = 1.5V$ . If  $V_{BIAS}$  is higher than  $3.3 V \times 0.95$  or  $V_{OUT}$  is less than 1.5 V,  $V_{IN}$  dropout is less than specified.

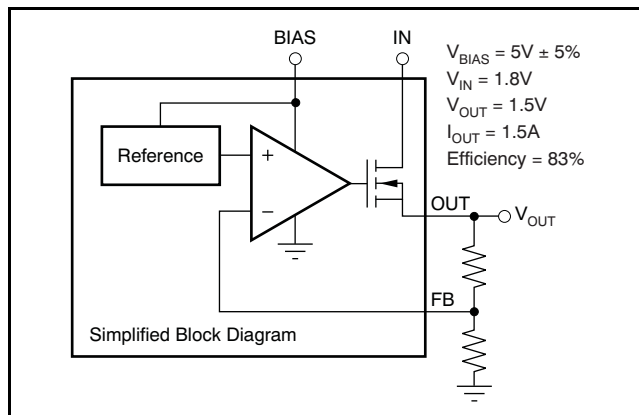

**Figure 29. Typical Application of the TPS74401 Using an Auxiliary Bias Rail**

The second specification (see Figure 30) is referred to as  $V_{BIAS}$  Dropout and is for users that wish to tie IN and BIAS together. This option allows the device to be used in applications where an auxiliary bias voltage is not available or low dropout is not required. Dropout is limited by BIAS in these applications because  $V_{BIAS}$  provides the gate drive to the pass FET and therefore must be 1.62 V above  $V_{OUT}$ . Because of this usage, IN and BIAS tied together easily consume huge power. Pay attention not to exceed the power rating of the IC package.

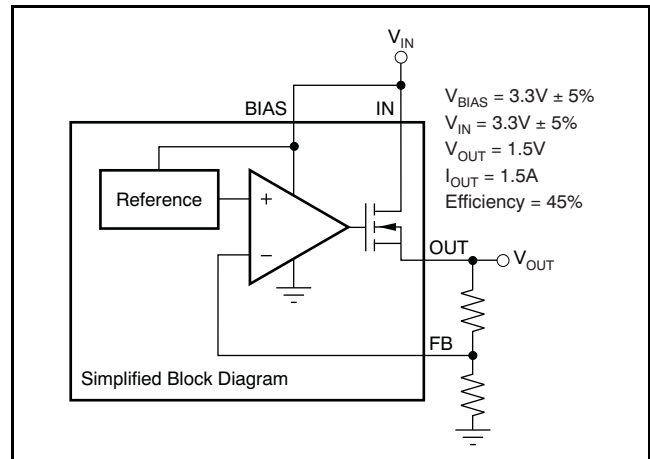

**Figure 30. Typical Application of the TPS74401 Without an Auxiliary Bias**

## PROGRAMMABLE SOFT-START

The TPS74401 features a programmable, monotonic, voltage-controlled soft-start that is set with an external capacitor ( $C_{SS}$ ). This feature is important for many applications because it eliminates power-up initialization problems when powering FPGAs, DSPs, or other processors. The controlled voltage ramp of the output also reduces peak inrush current during start-up, minimizing start-up transients to the input power bus.

To achieve a linear and monotonic soft-start, the TPS74401 error amplifier tracks the voltage ramp of the external soft-start capacitor until the voltage exceeds the internal reference. The soft-start ramp time depends on the soft-start charging current ( $I_{SS}$ ), the soft-start capacitance ( $C_{SS}$ ), and the internal reference voltage ( $V_{REF}$ ), and can be calculated using Equation 1:

$$t_{SS} = \frac{(V_{REF} \times C_{SS})}{I_{SS}} \quad (1)$$

If large output capacitors are used, the device current limit ( $I_{CL}$ ) and the output capacitor may set the start-up time. In this case, the start-up time is given by Equation 2:

$$t_{SSCL} = \frac{(V_{OUT(NOM)} \times C_{OUT})}{I_{CL(MIN)}} \quad (2)$$

$V_{OUT(NOM)}$  is the nominal set output voltage as set by the user,  $C_{OUT}$  is the output capacitance, and  $I_{CL(MIN)}$  is the minimum current limit for the device. In applications where monotonic startup is required, the soft-start time given by Equation 1 should be set to be greater than Equation 2.

The maximum recommended soft-start capacitor is 0.015  $\mu\text{F}$ . Larger soft-start capacitors can be used and will not damage the device; however, the soft-start capacitor discharge circuit may not be able to fully discharge the soft-start capacitor when re-enabled. Soft-start capacitors larger than 0.015  $\mu\text{F}$  could be a problem in applications where the user needs to rapidly pulse the enable pin and still requires the device to soft-start from ground.  $C_{\text{SS}}$  must be low-leakage; X7R, X5R, or C0G dielectric materials are preferred. Refer to [Table 3](#) for suggested soft-start capacitor values.

## SEQUENCING REQUIREMENTS

The device can have  $V_{\text{IN}}$ ,  $V_{\text{BIAS}}$ , and  $V_{\text{EN}}$  sequenced in any order without causing damage to the device. However, for the soft-start function to work as intended, certain sequencing rules must be applied. Enabling the device after  $V_{\text{IN}}$  and  $V_{\text{BIAS}}$  are present is preferred, and can be accomplished using a digital output from a processor or supply supervisor. An analog signal from an external RC circuit, as shown in [Figure 31](#), can also be used as long as the delay time is long enough for  $V_{\text{IN}}$  and  $V_{\text{BIAS}}$  to be present.

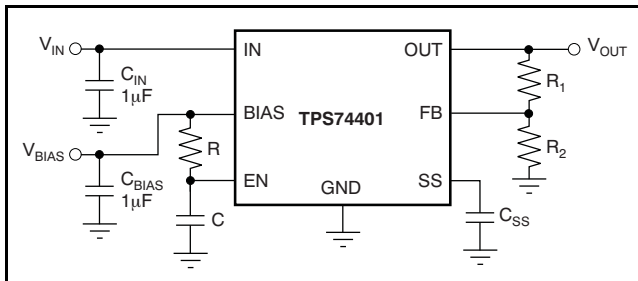

**Figure 31. Soft-Start Delay Using an RC Circuit on Enable**

If a signal is not available to enable the device after  $V_{\text{IN}}$  and  $V_{\text{BIAS}}$ , simply connecting  $V_{\text{EN}}$  to  $V_{\text{IN}}$  is acceptable for most applications as long as  $V_{\text{IN}}$  is greater than 1.1 V and the ramp rate of  $V_{\text{IN}}$  and  $V_{\text{BIAS}}$  is faster than the set soft-start ramp rate. If the ramp rate of the input sources is slower than the set soft-start time, the output will track the slower supply minus the dropout voltage until it reaches the set output voltage. If  $V_{\text{EN}}$  is connected to  $V_{\text{BIAS}}$ , the device will soft-start as programmed provided that  $V_{\text{IN}}$  is present before  $V_{\text{BIAS}}$ . If  $V_{\text{BIAS}}$  and  $V_{\text{EN}}$  are present before  $V_{\text{IN}}$  is applied and the set soft-start time has expired then  $V_{\text{OUT}}$  will track  $V_{\text{IN}}$ .

**NOTE:** When  $V_{\text{BIAS}}$  and  $V_{\text{EN}}$  are present and  $V_{\text{IN}}$  is not supplied, this device outputs approximately 50  $\mu\text{A}$  of current from  $V_{\text{OUT}}$ . Although this condition will not cause any damage to the device, the output current may charge up the  $V_{\text{OUT}}$  node if total resistance between  $V_{\text{OUT}}$  and  $V_{\text{GND}}$  (including external feedback resistors) is greater than 10  $\text{k}\Omega$ .

## OUTPUT NOISE

The TPS74401 provides low output noise when a soft-start capacitor is used. When the device reaches the end of the soft-start cycle, the soft-start capacitor serves as a filter for the internal reference. By using a 0.001- $\mu\text{F}$  soft-start capacitor, the output noise is reduced by half and is typically 19  $\mu\text{V}_{\text{RMS}}$  for a 1.2-V output (100 Hz to 100 kHz). Because most of the output noise is generated by the internal reference, the noise is a function of the set output voltage. The RMS noise with a 0.001- $\mu\text{F}$  soft-start capacitor is given in [Equation 3](#).

$$V_{\text{N}}(\mu\text{V}_{\text{RMS}}) = 16 \left( \frac{\mu\text{V}_{\text{RMS}}}{\text{V}} \right) \times V_{\text{OUT}}(\text{V}) \quad (3)$$

The low output noise of the TPS74401 makes it a good choice for powering transceivers, PLLs, or other noise-sensitive circuitry.

## ENABLE/SHUTDOWN

The enable ( $V_{\text{EN}}$ ) pin is active high and is compatible with standard digital signaling levels.  $V_{\text{EN}}$  below 0.4 V turns the regulator off, while  $V_{\text{EN}}$  above 1.1 V turns the regulator on. Unlike many regulators, the enable circuitry has hysteresis and deglitching for use with relatively slow-ramping analog signals. This configuration allows the TPS74401 to be enabled by connecting the output of another supply to the  $V_{\text{EN}}$  pin. The enable circuitry typically has 50 mV of hysteresis and a deglitch circuit to help avoid on-off cycling because of small glitches in the  $V_{\text{EN}}$  signal.

The enable threshold is typically 0.8 V and varies with temperature and process variations. Temperature variation is approximately  $-1 \text{ mV}/^\circ\text{C}$ ; therefore, process variation accounts for most of the variation in the enable threshold. If precise turn-on timing is required, a fast rise-time signal should be used to enable the TPS74401.

If not used,  $V_{\text{EN}}$  can be connected to either  $V_{\text{IN}}$  or  $V_{\text{BIAS}}$ . If  $V_{\text{EN}}$  is connected to  $V_{\text{IN}}$ , it should be connected as close as possible to the largest capacitance on the input to prevent voltage droops on that line from triggering the enable circuit.

## POWER-GOOD (QFN Package Only)

The power-good ( $V_{\text{PG}}$ ) pin is an open-drain output and can be connected to any 5.5 V or lower rail through an external pull-up resistor. This pin requires at least 1.1 V on  $V_{\text{BIAS}}$  in order to have a valid output. The  $V_{\text{PG}}$  output is high-impedance when  $V_{\text{OUT}}$  is greater than  $V_{\text{IT}} + V_{\text{HYS}}$ . If  $V_{\text{OUT}}$  drops below  $V_{\text{IT}}$  or if  $V_{\text{BIAS}}$  drops below 1.9 V, the open-drain output turns on and pulls the  $V_{\text{PG}}$  output low. The  $V_{\text{PG}}$  pin also asserts when the device is disabled. The recommended operating condition of  $V_{\text{PG}}$  pin sink current is up to 1 mA, so the



pull-up resistor for PG should be in the range of 10 kΩ to 1 MΩ. The pull-up resistor for PG should be in the range of 10 kΩ to 1 MΩ. PG is only provided on the QFN package. If output voltage monitoring is not needed, the PG pin can be left floating.

### INTERNAL CURRENT LIMIT

The TPS74401 features a factory-trimmed, accurate current limit that is flat over temperature and supply voltage. The current limit allows the device to supply surges of up to 3.5 A and maintain regulation. The current limit responds in about 10 μs to reduce the current during a short-circuit fault. Recovery from a short-circuit condition is well-controlled and results in very little output overshoot when the load is removed. See [Figure 27](#) in the Typical Characteristics section for short-circuit recovery performance.

The internal current limit protection circuitry of the TPS74401 is designed to protect against overload conditions. It is not intended to allow operation above the rated current of the device. Continuously running the TPS74401 above the rated current degrades device reliability.

### THERMAL PROTECTION

Thermal protection disables the output when the junction temperature rises to approximately +155°C, allowing the device to cool. When the junction temperature cools to approximately +140°C, the output circuitry is enabled. Depending on power dissipation, thermal resistance, and ambient temperature the thermal protection circuit may cycle on and off. This cycling limits the dissipation of the regulator, protecting it from damage as a result of overheating.

Activation of the thermal protection circuit indicates excessive power dissipation or inadequate heatsinking. For reliable operation, junction temperature should be limited to +125°C maximum. To estimate the margin of safety in a complete design (including heatsink), increase the ambient temperature until thermal protection is triggered; use worst-case loads and signal conditions. For good reliability, thermal protection should trigger at least +30°C above the maximum expected ambient condition of the application. This condition produces a worst-case junction temperature of +125°C at the highest expected ambient temperature and worst-case load.

The internal protection circuitry of the TPS74401 is designed to protect against overload conditions. It is not intended to replace proper heatsinking. Continuously running the TPS74401 into thermal shutdown degrades device reliability.

### LAYOUT RECOMMENDATIONS AND POWER DISSIPATION

An optimal layout can greatly improve transient performance, PSRR, and noise. To minimize the voltage droop on the input of the device during load transients, the capacitance on IN and BIAS should be connected as close as possible to the device. This capacitance also minimizes the effects of parasitic inductance and resistance of the input source and can therefore improve stability. To achieve optimal transient performance and accuracy, the top side of R<sub>1</sub> in [Figure 28](#) should be connected as close as possible to the load. If BIAS is connected to IN, it is recommended to connect BIAS as close to the sense point of the input supply as possible. This connection minimizes the voltage droop on BIAS during transient conditions and can improve the turn-on response.

Knowing the device power dissipation and proper sizing of the thermal plane that is connected to the tab or pad is critical to avoiding thermal shutdown and ensuring reliable operation. Power dissipation of the device depends on input voltage and load conditions, and can be calculated using [Equation 4](#):

$$P_D = (V_{IN} - V_{OUT}) \times I_{OUT} \quad (4)$$

Power dissipation can be minimized and greater efficiency can be achieved by using the lowest possible input voltage necessary to achieve the required output voltage regulation.

The primary conduction path for heat is through the exposed pad or tab to the printed circuit board (PCB). The pad or tab can be connected to ground or be left floating; however, it should be attached to an appropriate amount of copper PCB area to ensure the device does not overheat. The maximum junction-to-ambient thermal resistance depends on the maximum ambient temperature, maximum device junction temperature, and power dissipation of the device, and can be calculated using [Equation 5](#):

$$R_{\theta JA} = \frac{(+125^{\circ}\text{C} - T_A)}{P_D} \quad (5)$$

Knowing the maximum R<sub>θJA</sub> and system air flow, the minimum amount of PCB copper area needed for appropriate heatsinking can be calculated using [Figure 32](#) through [Figure 34](#).

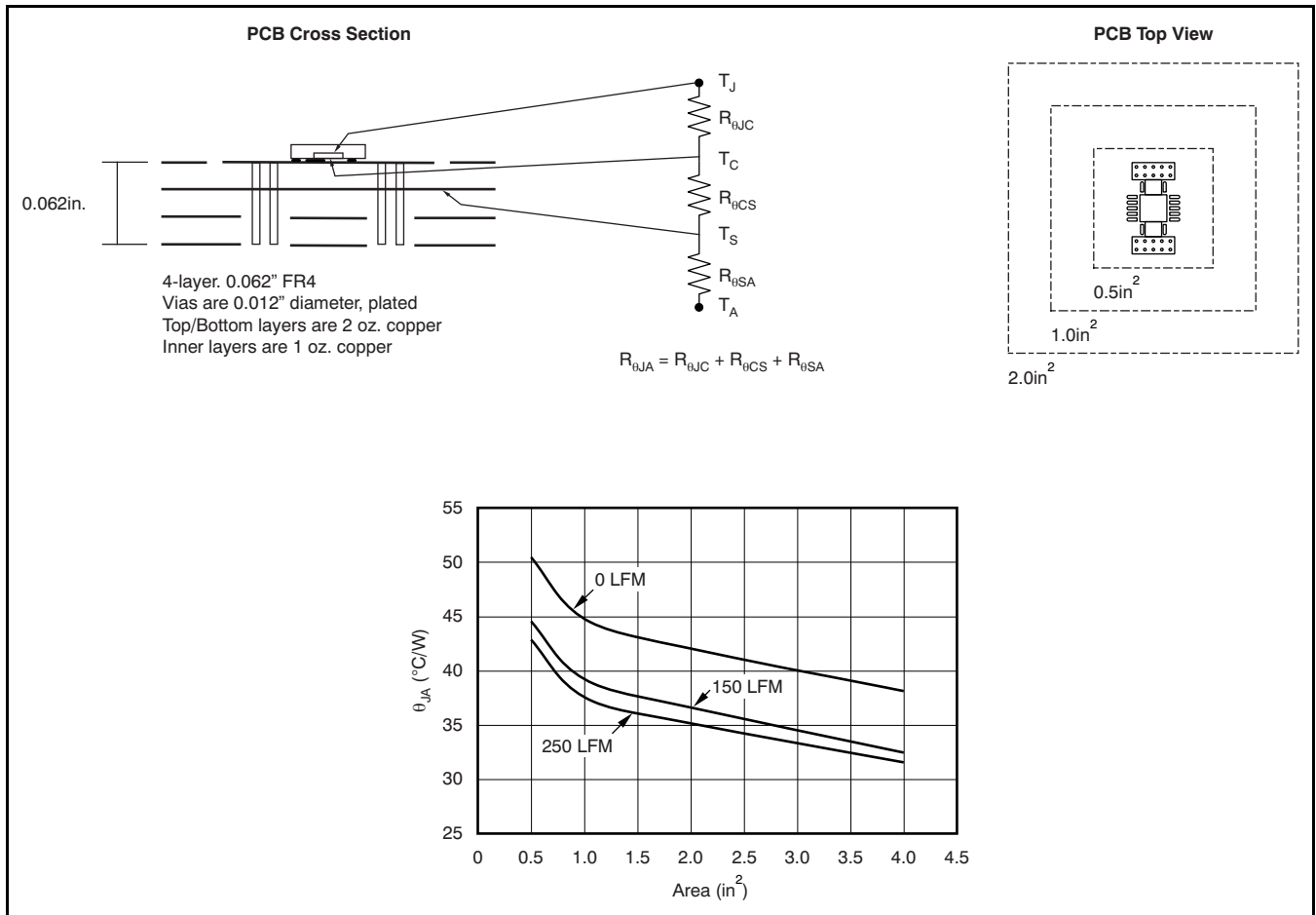

Figure 32. PCB Layout and Corresponding  $R_{\theta JA}$  Data, Buried Thermal Plane, No Vias Under Thermal Pad



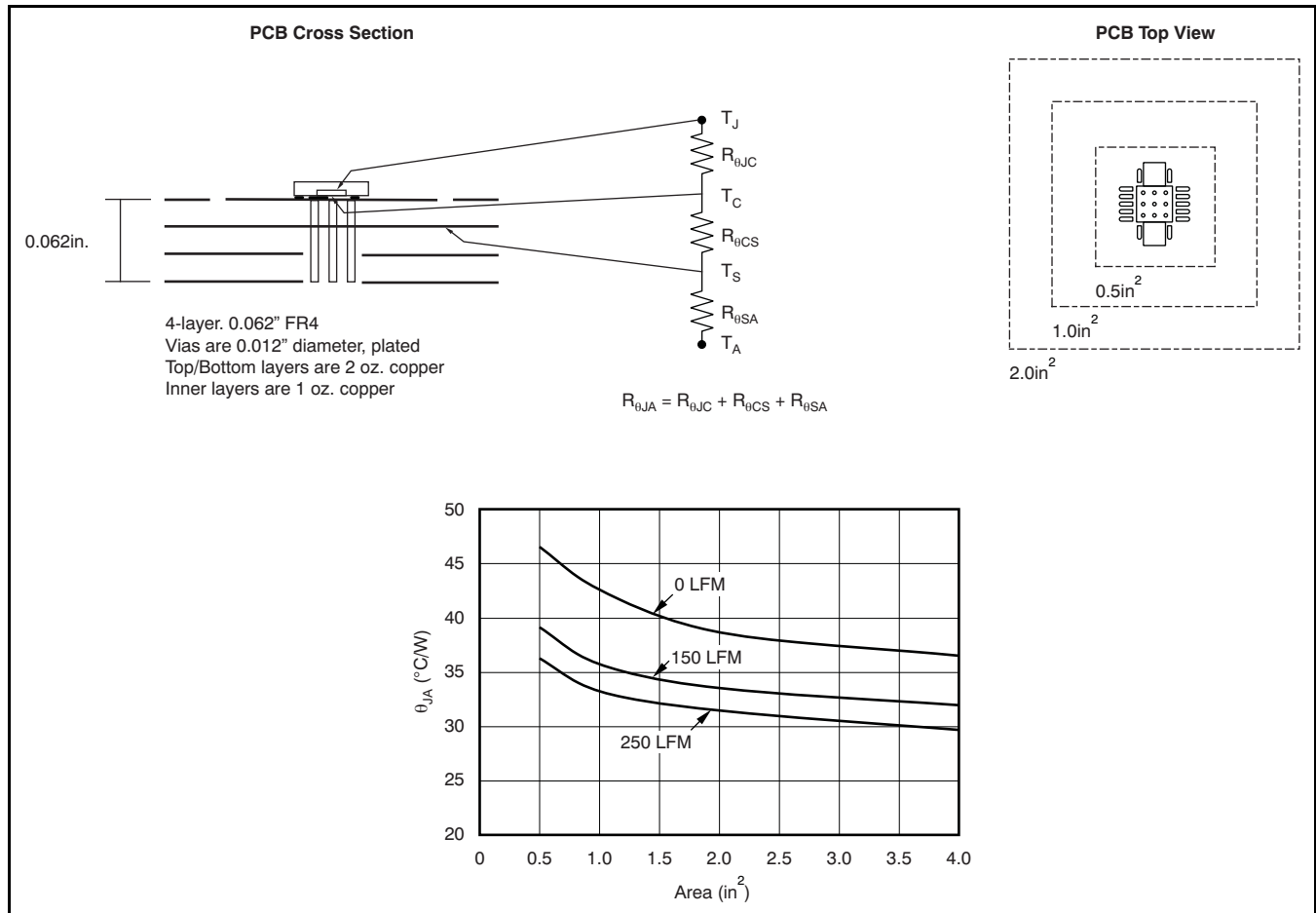

Figure 33. PCB Layout and Corresponding  $R_{\theta JA}$  Data, Buried Thermal Plane, Vias Under Thermal Pad

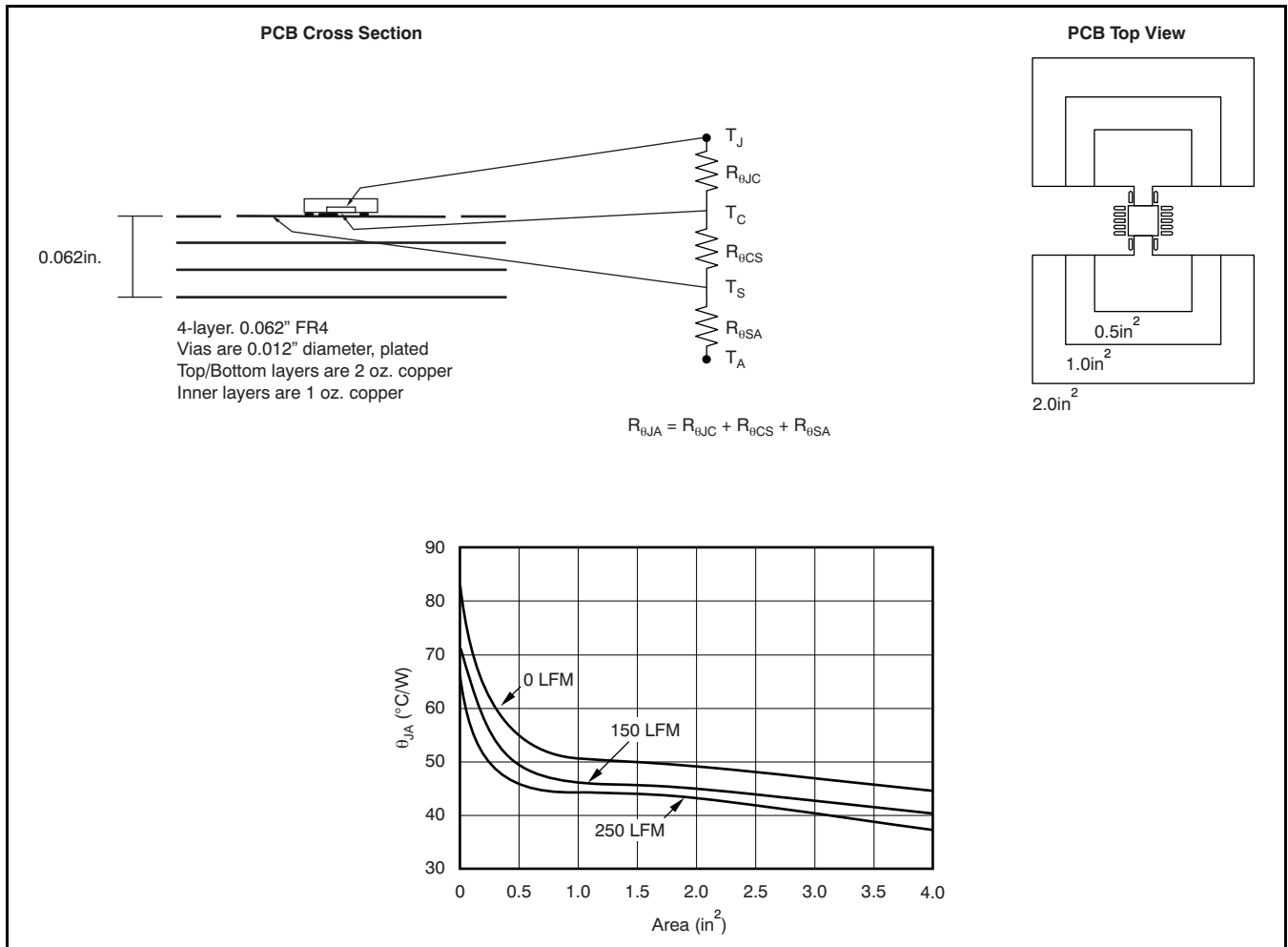



Figure 34. PCB Layout and Corresponding  $R_{\theta JA}$  Data, Top Layer Thermal Plane

**PACKAGING INFORMATION**

Orderable Device	Status (1)	Package Type	Package Drawing	Pins	Package Qty	Eco Plan (2)	Lead finish/ Ball material (6)	MSL Peak Temp (3)	Op Temp (°C)	Device Marking (4/5)	Samples
TPS74401MRGWREP	ACTIVE	VQFN	RGW	20	3000	RoHS & Green	NIPDAU	Level-2-260C-1 YEAR	-55 to 125	TPS 74401EP	
V62/10611-01XE	ACTIVE	VQFN	RGW	20	3000	RoHS & Green	NIPDAU	Level-2-260C-1 YEAR	-55 to 125	TPS 74401EP	

(1) The marketing status values are defined as follows:

**ACTIVE:** Product device recommended for new designs.

**LIFEBUY:** TI has announced that the device will be discontinued, and a lifetime-buy period is in effect.

**NRND:** Not recommended for new designs. Device is in production to support existing customers, but TI does not recommend using this part in a new design.

**PREVIEW:** Device has been announced but is not in production. Samples may or may not be available.

**OBSOLETE:** TI has discontinued the production of the device.

(2) **RoHS:** TI defines "RoHS" to mean semiconductor products that are compliant with the current EU RoHS requirements for all 10 RoHS substances, including the requirement that RoHS substance do not exceed 0.1% by weight in homogeneous materials. Where designed to be soldered at high temperatures, "RoHS" products are suitable for use in specified lead-free processes. TI may reference these types of products as "Pb-Free".

**RoHS Exempt:** TI defines "RoHS Exempt" to mean products that contain lead but are compliant with EU RoHS pursuant to a specific EU RoHS exemption.

**Green:** TI defines "Green" to mean the content of Chlorine (Cl) and Bromine (Br) based flame retardants meet JS709B low halogen requirements of <=1000ppm threshold. Antimony trioxide based flame retardants must also meet the <=1000ppm threshold requirement.

(3) MSL, Peak Temp. - The Moisture Sensitivity Level rating according to the JEDEC industry standard classifications, and peak solder temperature.

(4) There may be additional marking, which relates to the logo, the lot trace code information, or the environmental category on the device.

(5) Multiple Device Markings will be inside parentheses. Only one Device Marking contained in parentheses and separated by a "~" will appear on a device. If a line is indented then it is a continuation of the previous line and the two combined represent the entire Device Marking for that device.

(6) Lead finish/Ball material - Orderable Devices may have multiple material finish options. Finish options are separated by a vertical ruled line. Lead finish/Ball material values may wrap to two lines if the finish value exceeds the maximum column width.

**Important Information and Disclaimer:**The information provided on this page represents TI's knowledge and belief as of the date that it is provided. TI bases its knowledge and belief on information provided by third parties, and makes no representation or warranty as to the accuracy of such information. Efforts are underway to better integrate information from third parties. TI has taken and continues to take reasonable steps to provide representative and accurate information but may not have conducted destructive testing or chemical analysis on incoming materials and chemicals. TI and TI suppliers consider certain information to be proprietary, and thus CAS numbers and other limited information may not be available for release.

In no event shall TI's liability arising out of such information exceed the total purchase price of the TI part(s) at issue in this document sold by TI to Customer on an annual basis.

**OTHER QUALIFIED VERSIONS OF TPS74401-EP :**

- Catalog: [TPS74401](#)

## NOTE: Qualified Version Definitions:

- Catalog - TI's standard catalog product

**TAPE AND REEL INFORMATION**

**QUADRANT ASSIGNMENTS FOR PIN 1 ORIENTATION IN TAPE**

\*All dimensions are nominal

Device	Package Type	Package Drawing	Pins	SPQ	Reel Diameter (mm)	Reel Width W1 (mm)	A0 (mm)	B0 (mm)	K0 (mm)	P1 (mm)	W (mm)	Pin1 Quadrant
TPS74401MRGWREP	VQFN	RGW	20	3000	330.0	12.4	5.3	5.3	1.5	8.0	12.0	Q2

**TAPE AND REEL BOX DIMENSIONS**



\*All dimensions are nominal

Device	Package Type	Package Drawing	Pins	SPQ	Length (mm)	Width (mm)	Height (mm)
TPS74401MRGWREP	VQFN	RGW	20	3000	356.0	356.0	35.0

## GENERIC PACKAGE VIEW

**RGW 20**

**VQFN - 1 mm max height**

5 x 5, 0.65 mm pitch

PLASTIC QUAD FLATPACK - NO LEAD

This image is a representation of the package family, actual package may vary.  
Refer to the product data sheet for package details.

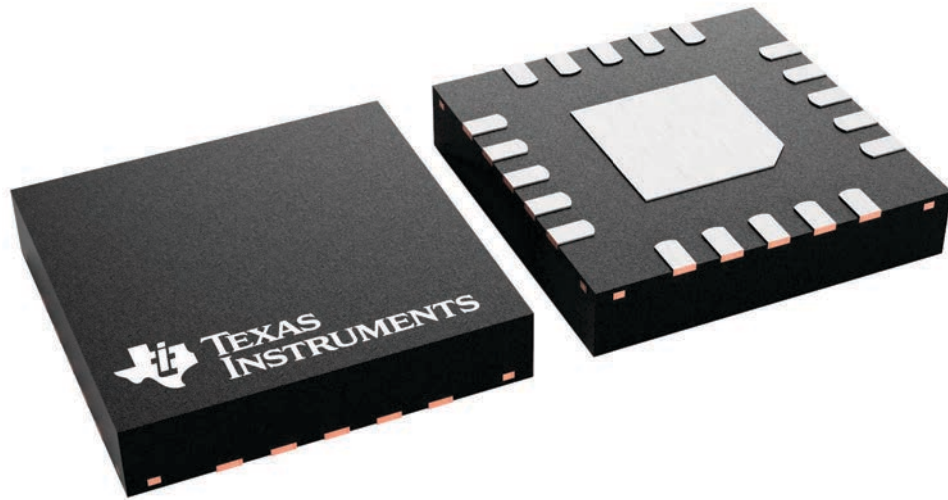

4227157/A

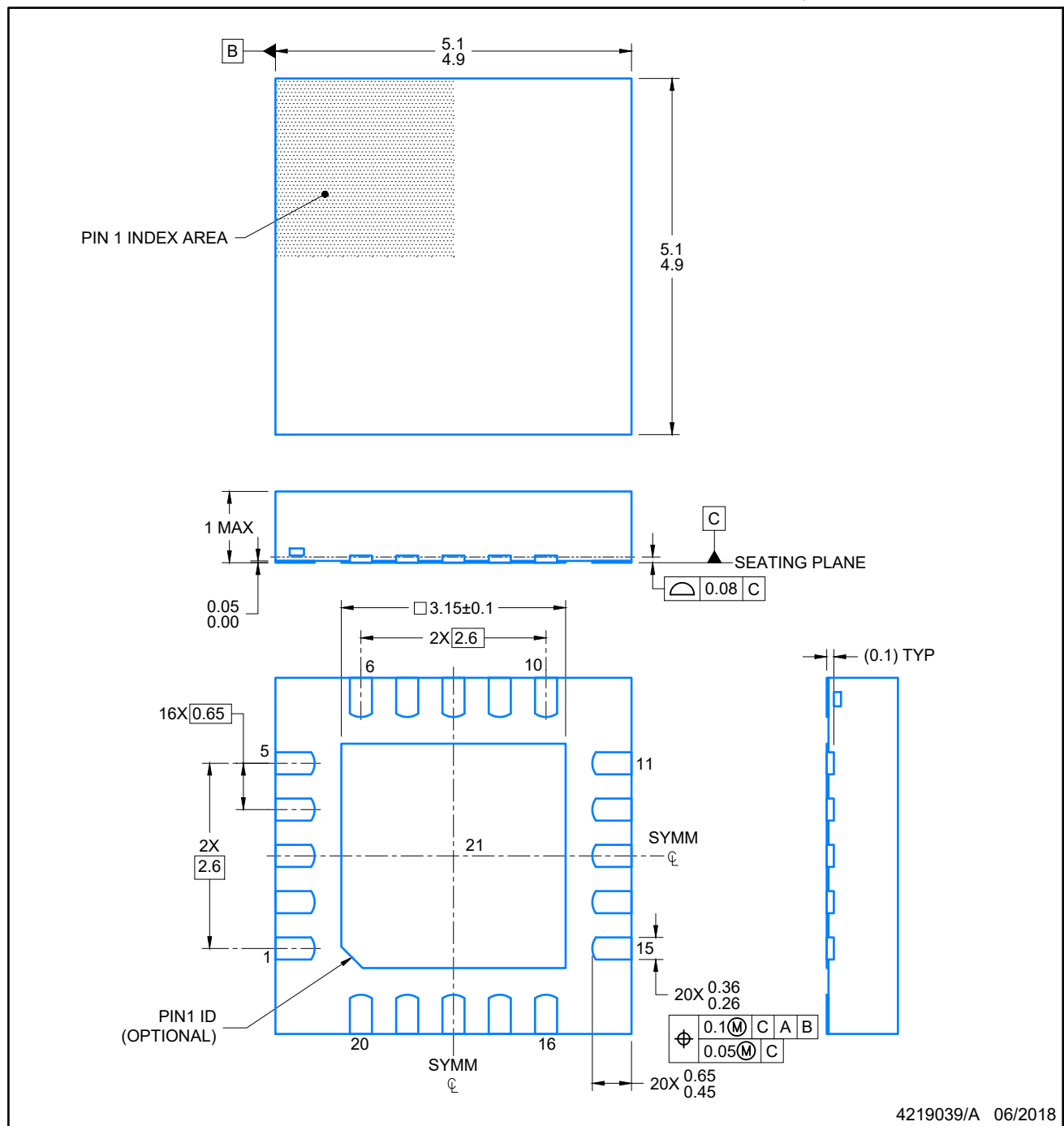

4219039/A 06/2018

NOTES:

1. All linear dimensions are in millimeters. Any dimensions in parenthesis are for reference only. Dimensioning and tolerancing per ASME Y14.5M.
2. This drawing is subject to change without notice.
3. The package thermal pad must be soldered to the printed circuit board for optimal thermal and mechanical performance.



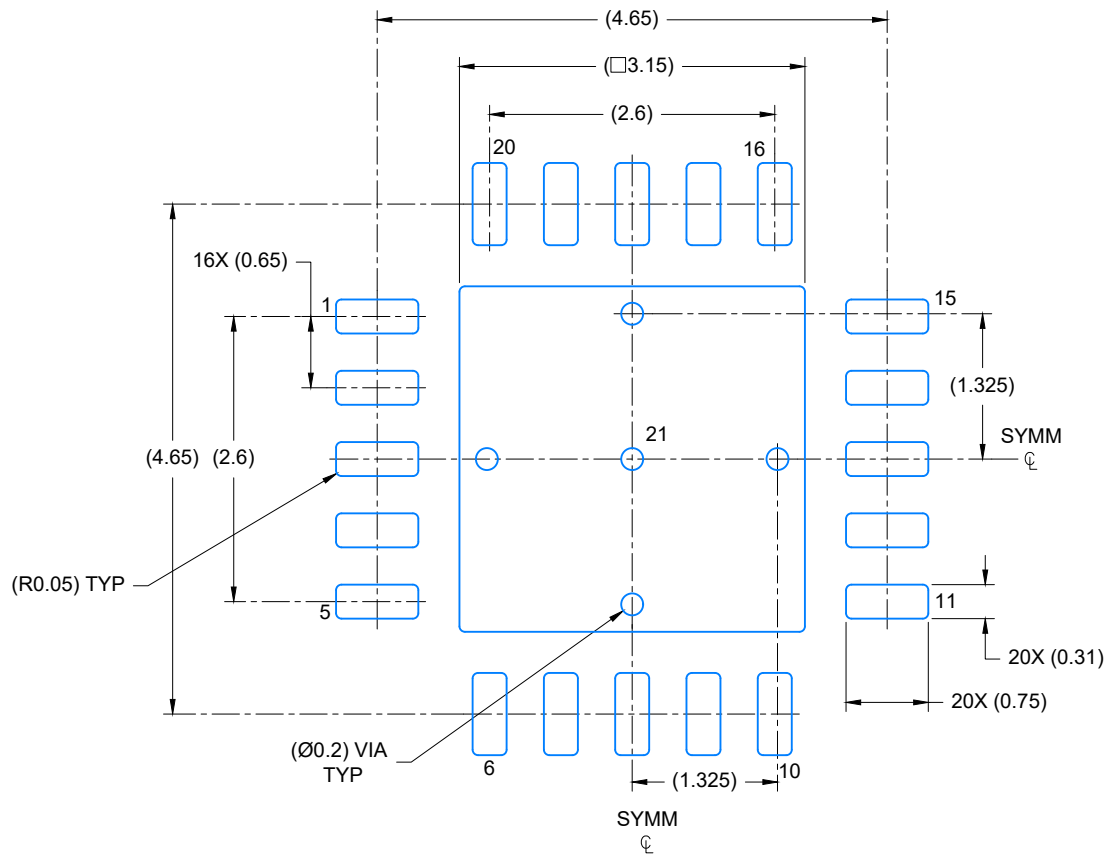

LAND PATTERN EXAMPLE

SCALE: 15X

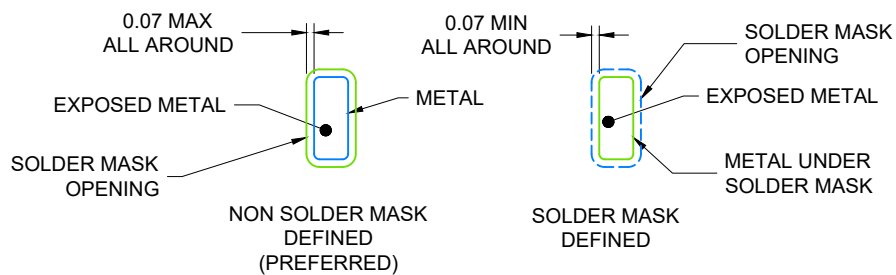

SOLDER MASK DETAILS

4219039/A 06/2018

NOTES: (continued)

4. This package is designed to be soldered to a thermal pad on the board. For more information, see Texas Instruments literature number SLUA271 ([www.ti.com/lit/slue271](http://www.ti.com/lit/slue271)).
5. Vias are optional depending on application, refer to device data sheet. If any vias are implemented, refer to their locations shown on this view. It is recommended that vias under paste be filled, plugged or tented.

# EXAMPLE STENCIL DESIGN

VQFN - 1 mm max height

RGW0020A

PLASTIC QUAD FLATPACK-NO LEAD

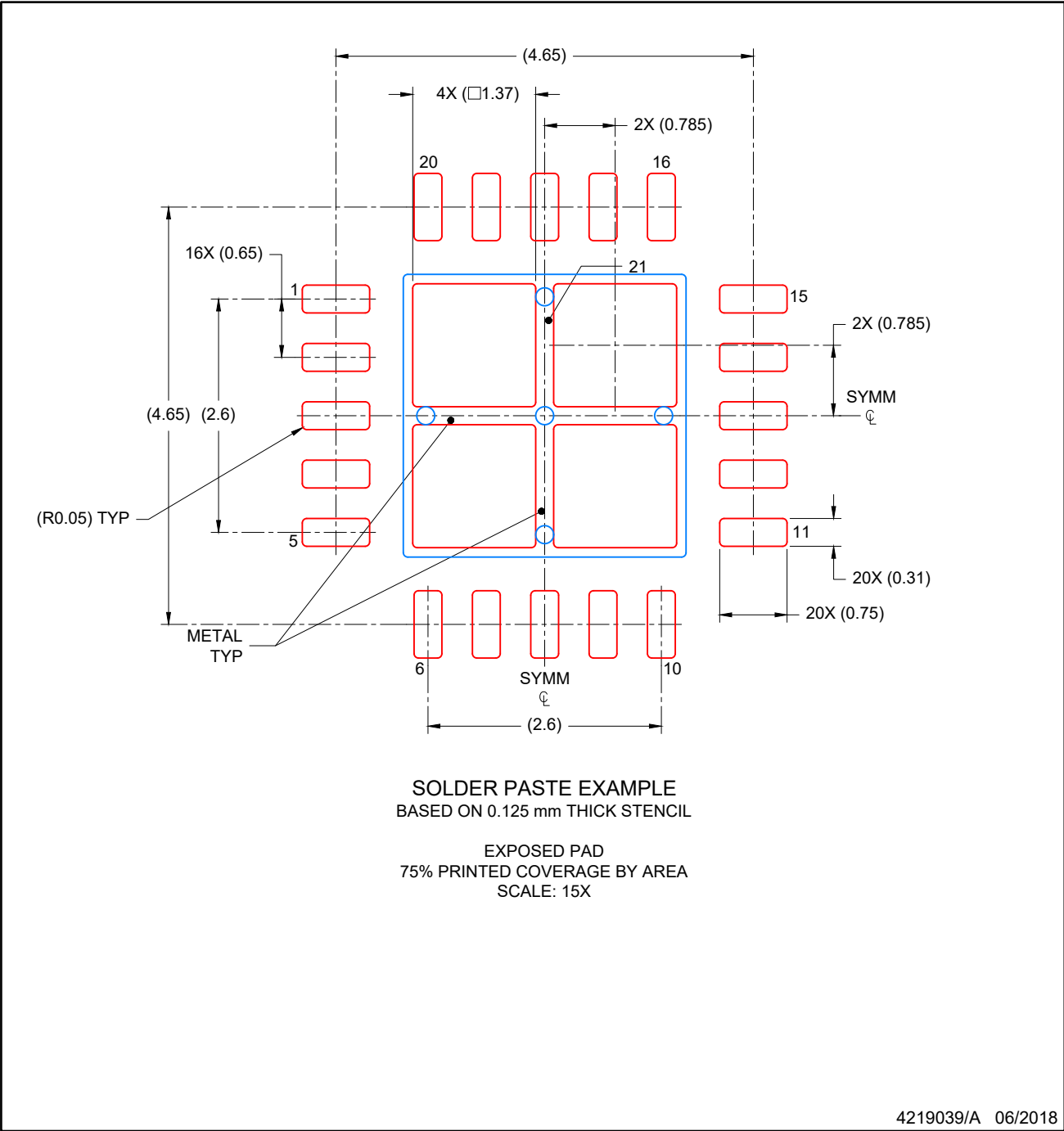

NOTES: (continued)

- 6. Laser cutting apertures with trapezoidal walls and rounded corners may offer better paste release. IPC-7525 may have alternate design recommendations.

## IMPORTANT NOTICE AND DISCLAIMER

TI PROVIDES TECHNICAL AND RELIABILITY DATA (INCLUDING DATA SHEETS), DESIGN RESOURCES (INCLUDING REFERENCE DESIGNS), APPLICATION OR OTHER DESIGN ADVICE, WEB TOOLS, SAFETY INFORMATION, AND OTHER RESOURCES "AS IS" AND WITH ALL FAULTS, AND DISCLAIMS ALL WARRANTIES, EXPRESS AND IMPLIED, INCLUDING WITHOUT LIMITATION ANY IMPLIED WARRANTIES OF MERCHANTABILITY, FITNESS FOR A PARTICULAR PURPOSE OR NON-INFRINGEMENT OF THIRD PARTY INTELLECTUAL PROPERTY RIGHTS.

These resources are intended for skilled developers designing with TI products. You are solely responsible for (1) selecting the appropriate TI products for your application, (2) designing, validating and testing your application, and (3) ensuring your application meets applicable standards, and any other safety, security, regulatory or other requirements.

These resources are subject to change without notice. TI grants you permission to use these resources only for development of an application that uses the TI products described in the resource. Other reproduction and display of these resources is prohibited. No license is granted to any other TI intellectual property right or to any third party intellectual property right. TI disclaims responsibility for, and you will fully indemnify TI and its representatives against, any claims, damages, costs, losses, and liabilities arising out of your use of these resources.

TI's products are provided subject to [TI's Terms of Sale](#) or other applicable terms available either on [ti.com](http://ti.com) or provided in conjunction with such TI products. TI's provision of these resources does not expand or otherwise alter TI's applicable warranties or warranty disclaimers for TI products.

TI objects to and rejects any additional or different terms you may have proposed.

Mailing Address: Texas Instruments, Post Office Box 655303, Dallas, Texas 75265  
Copyright © 2022, Texas Instruments Incorporated